

LIGHT AT THE HIGHEST LEVEL



2025/26

PROJECTS

OVERVIEW

ANBAULEUCHTEN | SURFACE MOUNTED LUMINAIRES | LUMINAIRES EN SAILLIE



LINE40
112



LINE50
114



LINE50hex
116



LINE50HEXmute
118



LINE50quad
120



LINE50QUADmute
122



LINE50splash
124



officeLINE50
126



LINE70
128



RING50
130



RING50mute
132



FLEX50
134



OVOID50
136



ROUND90
138

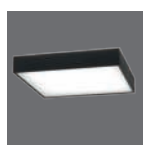

SQUARE90
140



techDOT150surface
142

HÄNGELEUCHTEN | PENDANT LUMINAIRES | SUSPENSIONS



LINE40
146



LINE50
148



LINE50hex
150



LINE50HEXmute
152



LINE50quad
154



LINE50QUADmute
156



LINE50splash
158



officeLINE50
160

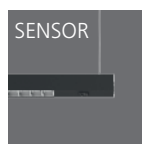

officeLINE50
162



LINE70
164



RING50
166



RING50mute
168



FLEX50
170



OVOID50
172



ROUND90
174



SQUARE90
176



ROPE22
178

WANDLEUCHTEN | WALL LUMINAIRES | APPLIQUES MURALES



LINE40
182



LINE50
184



LINE70
186



ROUND90
188



SQUARE90
190

EINBAULEUCHTEN | RECESSED LUMINAIRES | LUMINAIRES ENCASTRABLES



LINE40
194



LINE50
196



LINE50splash
198



officeLINE50
200



LINE70
202



RING50
204



FLEX50
206



ROUND90
208

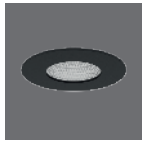

DOWN75
210



designDOT
212

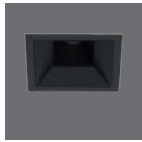

designSQOT
214



techDOT
216



techSQOT
218

STEH- UND TISCHKLEMMLEUCHTEN | FREE-STANDING AND DESK-MOUNTED LUMINAIRE | LAMPADAIRE, MONTAGE SUR TABLE



officeLINE50free
222



officeLINE50free
224

SCHIENENSTRAHLER | TRACK SPOTLIGHTS | PROJECTEURS SUR RAIL



GLOWmini
228



GLOWsmall
230



GLOWmedium
232



GLOWlarge
234



GLOWultra
236



GLOWgu10
238



trackS
240



trackM
242



LINE50
244



officeLINE50
246

LINE48V | LINE48V | LINE48V

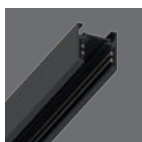

TRACKS
248



LUMINAIRES
276



DRIVERS
300



Geschätzte Geschäftspartner:innen, treue
EGLO Freund:innen,

wir freuen uns sehr, Ihnen den neuen Hauptkatalog von EGLO Professional präsentieren zu können. Mit diesem Katalog möchten wir Ihnen unsere umfangreiche Kollektion von hochwertigen Leuchten und Beleuchtungssystemen vorstellen, die wir mit viel Liebe zum Detail und einem besonderen Fokus auf Design, Energieeffizienz und Qualität entwickelt haben. Dieser Katalog startet eine neue Zeitrechnung im Bereich EGLO Professional, unter dem Motto „LIGHT AT THE HIGHEST LEVEL“ finden Sie in diesem Katalog eine riesige Auswahl an ausgewählten Standardprodukten auf allerhöchstem Qualitätsniveau und auf Stand der neuesten Technologien. Getreu unserem Leitspruch „DESIGNED IN AUSTRIA – MADE IN EUROPE“ freuen wir uns auf Ihre Anfrage über kundenspezifische Projektlösungen, welche wir in unserer hochmodernen Produktionsstätte in Pásztó (Ungarn) auftragsbezogen fertigen. Wir sind stolz darauf, Ihnen eine große Auswahl an hochwertigen Leuchten zu fairen Preisen anbieten zu können und sind uns sicher, dass Sie in unserem Katalog das perfekte Angebot für Ihre nächsten Projekte finden werden. Wir wünschen Ihnen viel Spaß beim Durchblättern unseres Katalogs und freuen uns darauf, mit Ihnen gemeinsam Ihre nächsten Projekte zu verwirklichen.

Dear business partners and loyal EGLO
friends,

we are delighted to present the new EGLO Professional main catalogue. With this catalogue, we would like to introduce you to our extensive collection of high-quality luminaires and lighting systems, which we have developed with great attention to detail and a special focus on design, energy efficiency and quality. This catalogue marks the start of a new era in the EGLO Professional range. Under the motto “LIGHT AT THE HIGHEST LEVEL”, you will find a huge selection of selected standard products of the very highest quality and state-of-the-art technology in this catalogue. True to our motto “DESIGNED IN AUSTRIA - MADE IN EUROPE”, we look forward to receiving your enquiry about customised project solutions, which we manufacture to order in our state-of-the-art production facility in Pásztó (Hungary). We are proud to be able to offer you a large selection of high-quality lights at fair prices and are sure that you will find the perfect offer for your next projects in our catalogue. We hope you enjoy browsing through our catalogue and look forward to working with you to realise your next projects.

Chers partenaires commerciaux, fidèles
amis d'EGLO,

Nous sommes très heureux de vous présenter le nouveau catalogue principal d'EGLO Professional. Avec ce catalogue, nous souhaitons vous présenter notre vaste collection de luminaires et de systèmes d'éclairage haut de gamme, que nous avons développés avec un grand souci du détail et un accent particulier sur le design, l'efficacité énergétique et la qualité. Ce catalogue marque le début d'une nouvelle ère pour EGLO Professional. Sous la devise “LIGHT AT THE HIGHEST LEVEL”, vous trouverez dans ce catalogue un vaste choix de produits standard sélectionnés avec le plus haut niveau de qualité et les technologies les plus récentes. Fidèles à notre devise “DESIGNED IN AUSTRIA - MADE IN EUROPE”, nous nous ferons un plaisir de répondre à vos demandes concernant des solutions de projets personnalisées, que nous fabriquons sur commande dans notre usine ultramoderne de Pásztó (Hongrie). Nous sommes fiers de pouvoir vous proposer un grand choix de luminaires de haute qualité à des prix équitables et nous sommes certains que vous trouverez dans notre catalogue l'offre parfaite pour vos prochains projets. Nous vous souhaitons beaucoup de plaisir à feuilleter notre catalogue et nous nous réjouissons de réaliser vos prochains projets avec vous.

Mag. René Tiefenbacher
CEO EGLO Group



CHECK OUT OUR WEBSITE!



GLOBAL NETWORKING



ALWAYS WITHIN REACH

Following the principle **"THINK GLOBAL - ACT LOCAL"**, customer proximity is a priority at EGLO.

Due to logistical and locational advantages, we guarantee excellent service for our end consumers. Individual needs can be addressed directly and promptly at a regional level, as our customer contacts are always within reach.

Furthermore, long delivery times are minimised by a well-developed logistics network, and products will easily find their way into consumer homes.

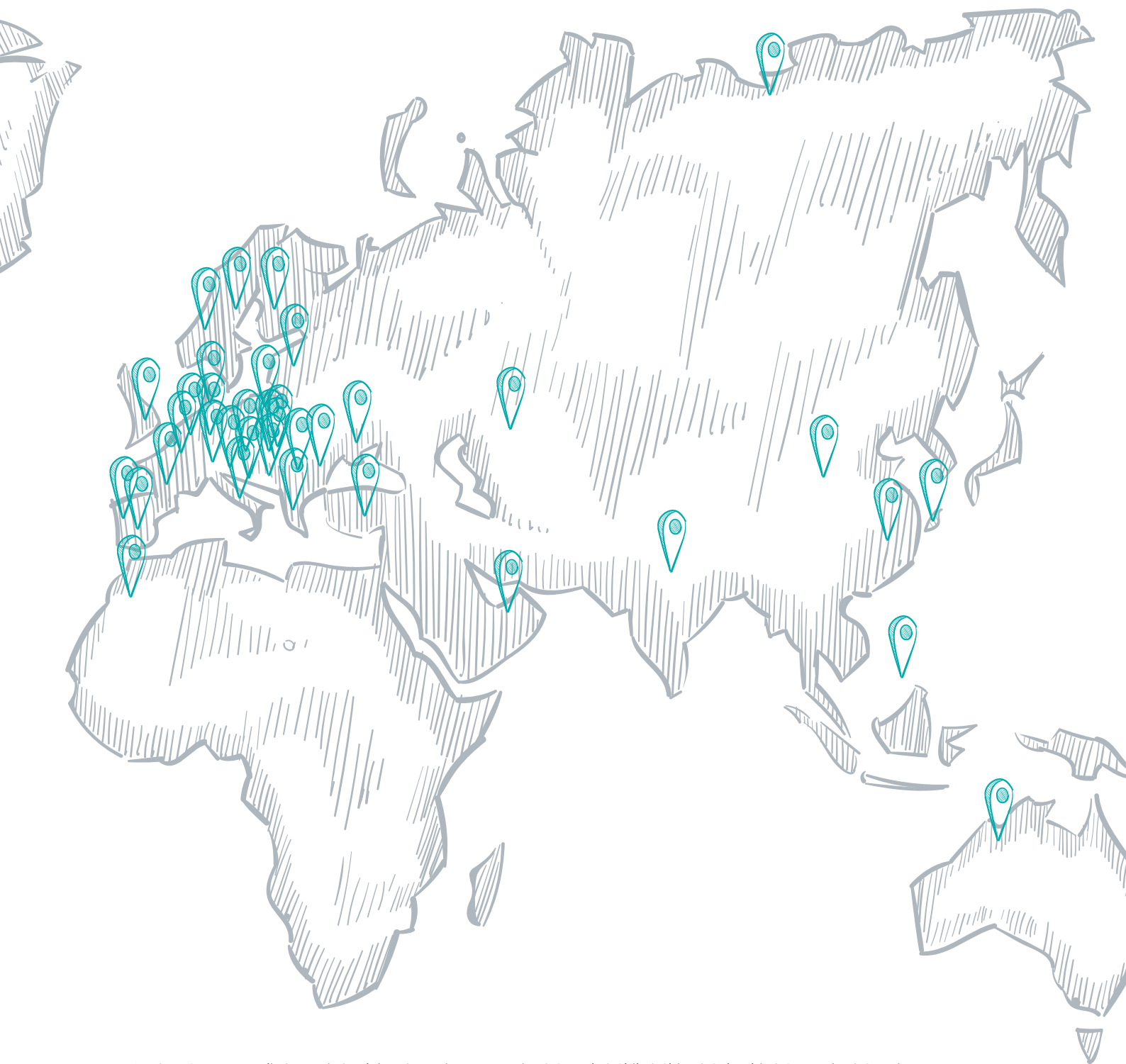

Our locations: Australia | Austria | Belgium | Bosnia-Herzegovina | Canada | Chile | China | Colombia | Costa Rica | Croatia | Czech Republic | Denmark | Estonia | Finland | France | Germany | Greece | Hong Kong | Hungary | India | Italy | Kazakhstan | Kosovo | Malaysia | Mexico | Morocco | Netherlands | Norway | Peru | Poland | Portugal | Romania | Russia | Serbia | Slovakia | Slovenia | Spain | Sweden | Switzerland | Taiwan | Turkey | Ukraine | United Arab Emirates | United Kingdom | USA

THE COMPANY

... since 1969



Employees

Over 5,500 motivated employees worldwide



Turnover

634 million euros



Sales Divisions

94 across the globe



Sold Products

100,000 products sold daily



Partnerships

In 120 countries on 6 continents



Warehouse & Storage Capacity

240,000 m² distributed over 18 warehouses worldwide



Production

in 3 Locations:
Hungary, China, and India, with 65,000 products produced per day



Newness

1,000 new designs and products per year



Design

80% of our own designs



EGLO'S HISTORY

From the heart of Tyrol to the **world**.

EGLO's **success story** began around 50 years ago when Ludwig Obwieser opened a small electrical retailer, which has since become a global corporation in the interior and exterior lighting industry. EGLO's history was established in 1969 when the founder returned from a trip to Milan. Soon after, the first Italian lights landed in the shop windows of specialist retailers. After the first orders in Salzburg, Austria, EGLO expanded, and production started in Pill, Tyrol - where the company headquarters remains.

The **company's development** continues to accelerate at high speeds: from the number of employees and sales development to the production facilities and subsidiaries around the world. For EGLO to continue future growth, business development is driven forward with sustainable thinking. With the concept of the EGLO World of Lights, a flagship showroom near the headquarters, EGLO is showing its love for lighting and paving the way for an even brighter future.

EGLO is a family business and can therefore act independently. From the start, control over development, production and logistics has been a **success factor** for business growth. For that reason, EGLO continues to observe market developments closely, manufactures products efficiently and offers care and support to all customers.

Every day we learn and invest in our customers, our partners, our employees, our products and our service - worldwide.

OUR MILESTONES

1969

Foundation

By Ludwig Obwieser

1986

Globalisation

EGLO's globalisation began in the 80s and 90s. The first step was taken in 1986 when a sales company was founded in Germany



2001

Commissioning: Production Facility in China

Opening of the site in China, incl. showroom and production building

2016

Expanding the Range: Smart Lights

Development and production of Smart Lights: EGLO connect

1976

In-House Production

At the company headquarters in Pill



1994

Commissioning: Production Facility in Hungary

Expansion through a company-owned production facility in Pásztó, Hungary

2015

Commissioning: Production Facility in India

Another expansion for EGLO's Lighting production



2017

Extension: Hungary Location

Expansion of the warehouse and production area in Hungary

2019

Expanding the Range: EGLO Fans

Development and introduction of ceiling fans

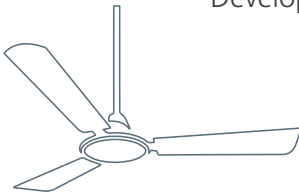

2019

Market Launch: EGLO Webshops

Optimisation of international EGLO websites & establishment of country specific Webshops

2020

Expansion of the Product Portfolio

Majority takeover of the Swedish company Star Trading



2020

Investment: In the Smart Control Industry

Acquisition of the company AwoX SAS in France for further development in the field of Smart Control

2021

Commissioning: Logistics Centre in Magdeburg

Storage space for around 74,000 pallets, optimised e-Commerce shipping area, and 150 employees on site



2021

Bartenbach

Acquisition of shares in the most important independent lighting designer in Europe

2022

Expanding the Range

Introduction of the EGLO Living brand

2023

EGLO World of Lights

Opening of the largest lighting showroom in Europe

WHAT WE STAND FOR OUR MISSION

OUR GUIDING PRINCIPLE

01

PROFESSIONALISM & VALUE

As an established, professional supplier of luminaires and lighting systems, we guarantee our customers and partners sustainable added value through responsible action.

02

QUALITY & SATISFACTION

We pursue the goal of conveying the joy of high-end lighting solutions to our customers and partners through appealing products at a high level of quality.

03

ALL-ROUNDER & SERVICE PROVIDER

As an all-rounder and full-service provider, it is important to us to support customers and partners in the purchase of appealing products in all life (lighting) situations with a consistently high delivery rate.

04

MOTIVATION & SOLUTIONS

Motivated employees and top managers enable us to make decisions quickly and thus focus on competent solutions for customers and partners.

05

GLOBALISATION & EXPERTISE

Our focus is to bring EGLO lighting solutions to our partners' projects worldwide and to be the most competent partner for our customers.



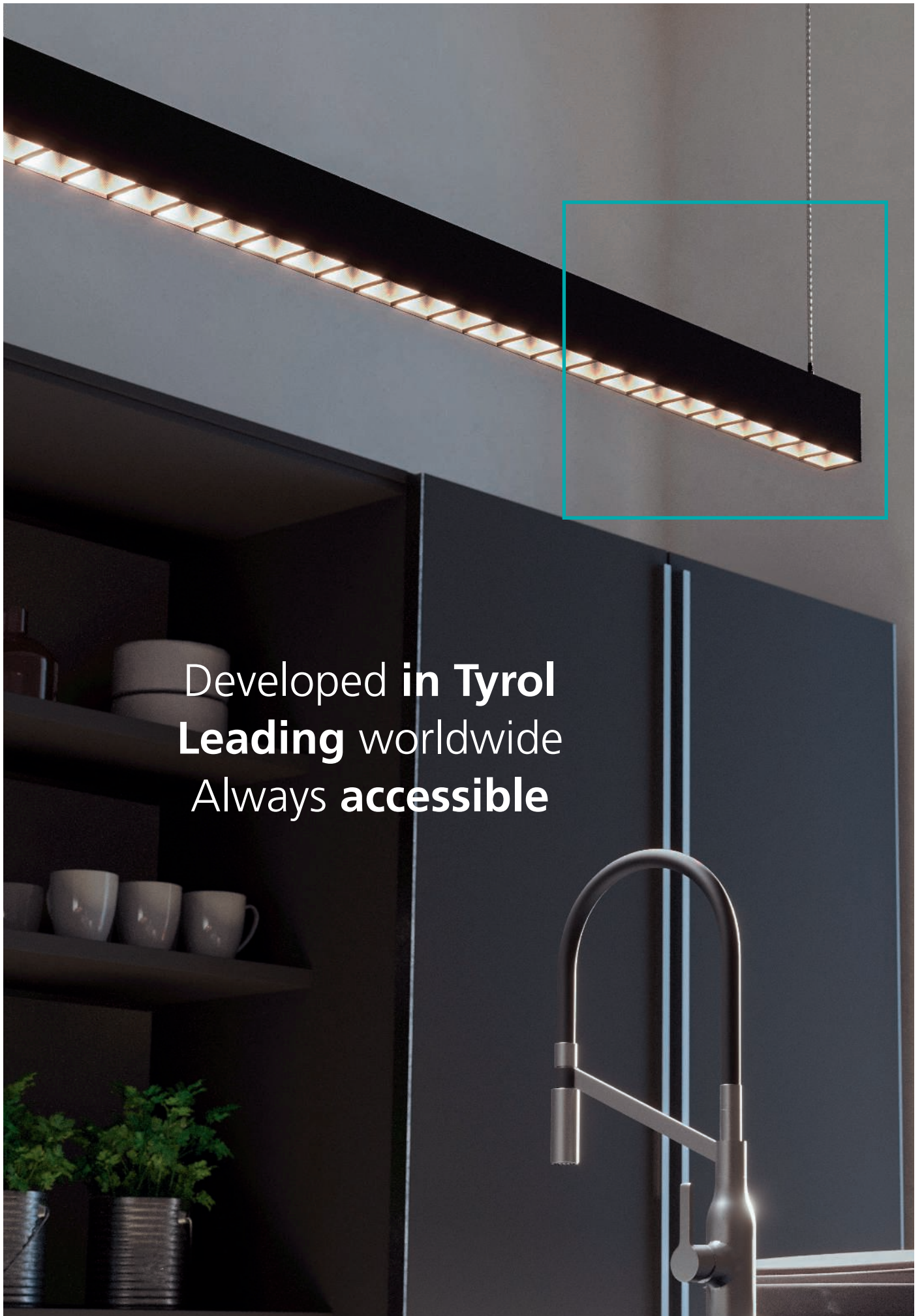

Developed in **Tyrol**
Leading worldwide
Always **accessible**

OUR MISSION

We design luminaires for our customers following the EGLO philosophy:

my light | my style

OUR VISION

Pairing contemporary designs with high functionality at affordable prices, suitable for any space.

SUSTAINABILITY IN A NEW LIGHT

... because the **environment** is important to us.

Sustainability is a top priority at EGLO. In 2022, the EGLO headquarters and the production facility in India were ISO 14001 certified. Since then, we continue to ensure other production facilities and global branches are certified and working towards becoming climate-neutral. We are proud to have received the climate-neutral company approval for our headquarters, and we can offer customers climate-neutral products worldwide.

At EGLO, we work sustainably on all levels. Therefore, it is important to us that we involve employees and inform them about newly implemented environmentally friendly measures. As a global company, we ensure fair pay, health and safety at work while committing ourselves and our suppliers to comply with **BSCI** and International Labour Organization (ILO) guidelines.

From Pill to around the world, together with our subsidiaries and production facilities, we pay attention to the efficient use of resources and value environmentally friendly and natural materials. For this reason, we work tirelessly to expand the certifications of our product groups and locations.

With **recyclable, compostable, and biodegradable packaging** we are gradually paving the way to a more sustainable future.

Many of the materials, luminaires, furniture, and decorative items used at EGLO are already **FSC**-certified. Furthermore, we are proud that all our production sites and 35 EGLO branches also hold the **FSC** certification.

EGLO is committed to meeting **11 of the 17 UN Sustainable Development Goals (SDGs)**. Thus, supporting sustainable projects and research for a better and greener future.



GOALS

FOR SUSTAINABLE DEVELOPMENT (SDGs)

1. No Poverty (*SDG 1*)
2. Zero Hunger (*SDG 2*)
3. Good Health and Well-being (*SDG 3*)
4. Quality Education (*SDG 4*)
5. Clean Water and Sanitation (*SDG 6*)
6. Affordable and Clean Energy (*SDG 7*)
7. Decent Work and Economic Growth (*SDG 8*)
8. Industry, Innovation, and Infrastructure (*SDG 9*)
9. Climate Action (*SDG 13*)
10. Life on Land (*SDG 15*)
11. Partnerships to Achieve the Goals (*SDG 17*)



IN-HOUSE PRODUCTION



EGLO's second largest logistics location and at the same time oldest production facility in Pásztó, Hungary bundles a wide range of core competencies, making the location an important hub of the EGLO Group. The branch is characterised by its special know-how in the field of packaging and logistics as well as wood production for POS and lighting equipment. Furthermore, Pásztó focuses on customer-specific adaptations, volume-intensive manufacturing and serves as a specialized workshop for the production of EGLO Professional products.

EGLO Professional products are manufactured in our state-of-the-art factory in Hungary - MADE IN EUROPE. Unlike most of our competitors, we still manufacture our own products and are not just a trader. This means that we can modify production processes at very short notice and thus realise your individually customised products with maximum flexibility at unbeatable price/performance ratios.

With EGLO Professional, you will therefore be receiving high-quality products made with sophisticated lighting technology at an unbeatable price/performance ratio. Our very high degree of in-house production using our own metalworking facilities, laser-cutting equipment, ultra-modern powder coating plant, large-format printer for a wide range of materials, and our own packaging production, and complex operations such as hand-painting our products or applying gold leaf ensure maximum flexibility!

By using premium quality and top efficiency LEDs, we can achieve very high luminous efficiencies with a long service life, resulting in considerable savings in energy and maintenance costs.

OUR QUALITY PLEDGE!

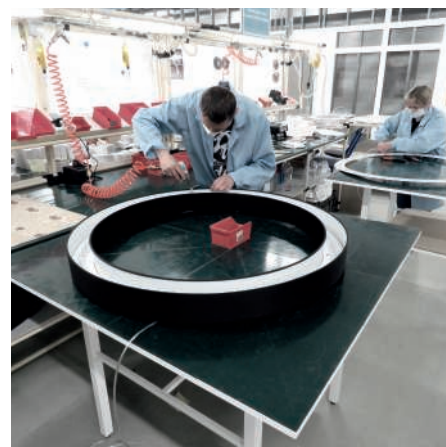

PRODUCTION

100% quality standard!

Our LED drivers comes exclusively from renowned European manufacturers.

Our in-house laboratories with photometric measuring equipment (photogoniometer & integrating sphere), lifetime measurement, damp room and temperature simulation enable us to guarantee the technical and qualitative safety of our products in the best possible way.

Due to the use of high-quality components and professional in-house production, we can offer a 5-year guarantee on our EGLO Professional articles.

On request we are able to do "Special designs" from single items to small series and large series.



PRODUKT FAMILIEN

Product Families

Familles De Produits



LINE40

HIGH EFFICIENCY

The high luminous output at low power provides an energy efficient luminaire – up to 142 lm/W.

4 MOUNTING VERSIONS

The luminaire is available as surface, pendant, recessed or wall luminaire.

MAKE YOUR WISH COME TRUE

An including sensor, emergency light or many other options are available on demand.

INDIVIDUAL SHAPES

Due to a modular system, we can make a special form for your desire.

LIGHT WHERE YOU WANT IT

The luminaire is available either with direct light only or also with additional indirect light.

SMALL SIZE

The direct luminaire has a height of 62mm – 10mm less than the direct + indirect profile.

DIFFERENT COLOURS

The housing is available in RAL 9005 black, RAL 9006 silver and RAL 9016 white – RAL of your choice on demand.

DYNAMIC WHITE

Besides the unicoloured colour temperatures, dynamic white (2700K-6500K) is also available.

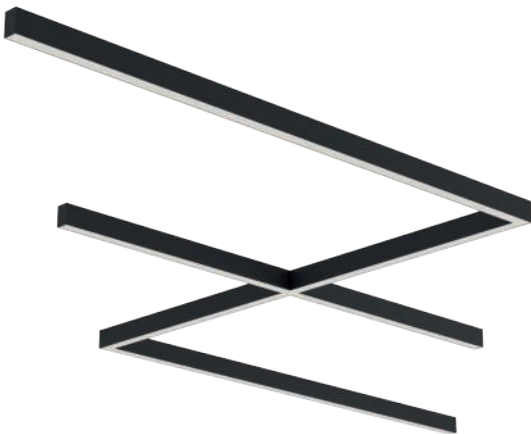

3 DIFFERENT DIRECT COVERS

- Opal flat
- Microprism flat
- Opal U-shaped

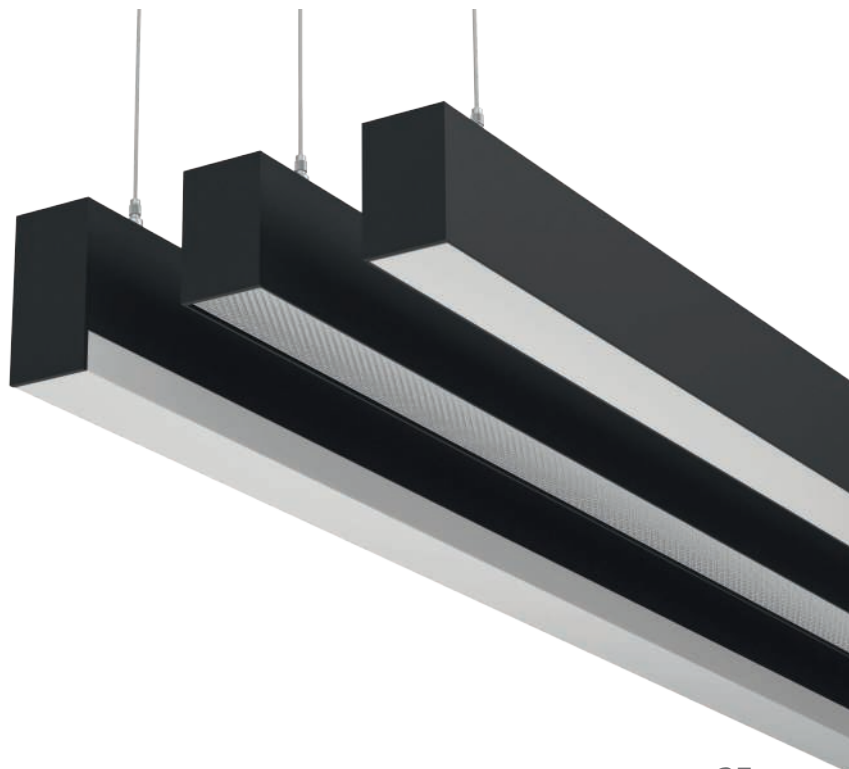

LINE40

ÜBERSICHT | OVERVIEW | VUE D'ENSEMBLE

ANBAULEUCHE | SURFACE MOUNTED LUMINAIRE | LUMINAIRE EN SAILLIE

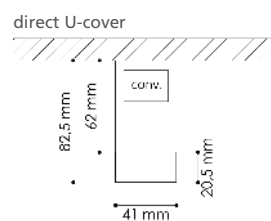
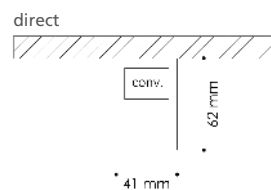

HÄNGELEUCHE | PENDANT LUMINAIRE | SUSPENSION

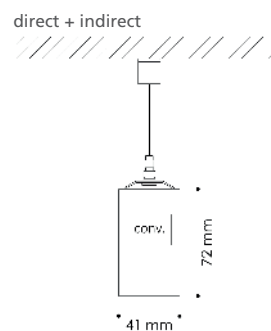
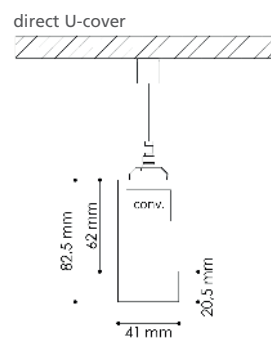
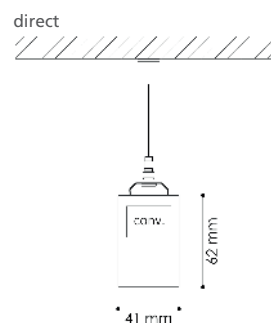
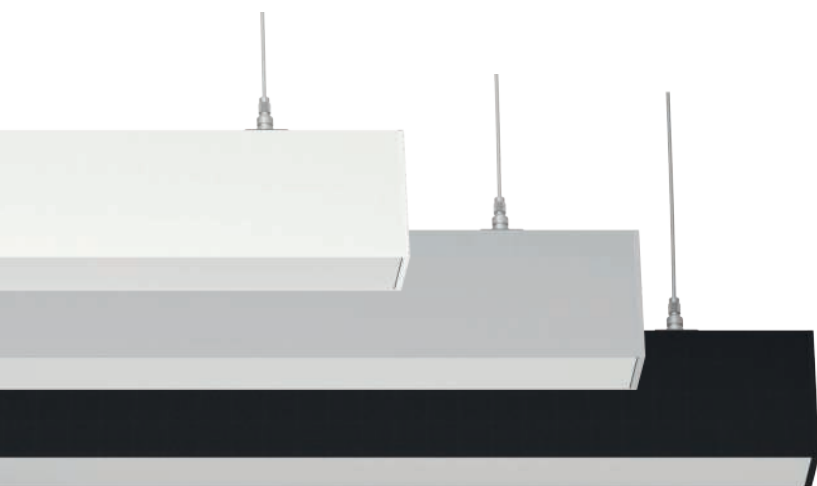

LINE40

ÜBERSICHT | OVERVIEW | VUE D'ENSEMBLE

WANDLEUCHE | WALL LUMINAIRE | APPLIQUE MURALE

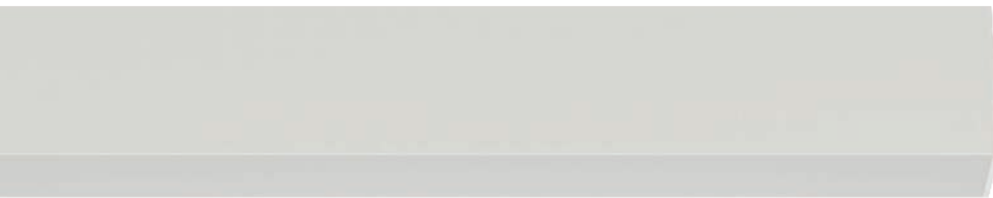

direct

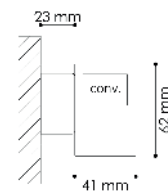

direct + indirect

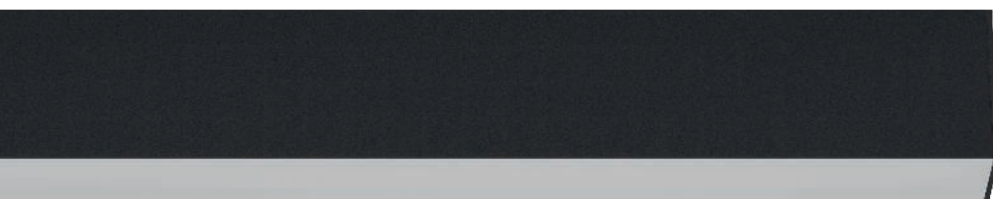
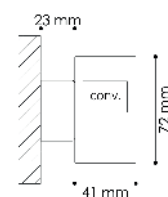

EINBAULEUCHE | RECESSED LUMINAIRE | LUMINAIRE ENCASTRABLE

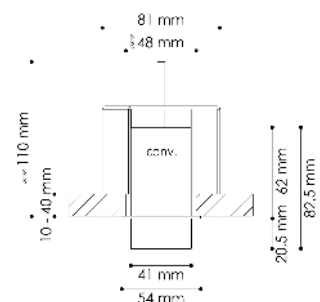
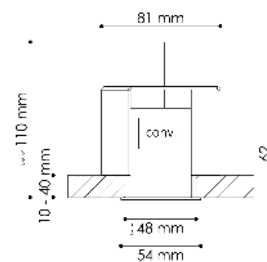



LINE50

HIGH EFFICIENCY

The high luminous output at low power provides an energy efficient luminaire – up to 149 lm/W.

4 MOUNTING VERSIONS

The luminaire is available as surface, pendant, recessed or wall luminaire.

DYNAMIC WHITE

Besides the unicoloured colour temperatures, dynamic white (2700K–6500K) is also available.

MAKE YOUR WISH COME TRUE

An including sensor, emergency light or many other options are available on demand.

INDIVIDUAL SHAPES

Due to a modular system, we can make a special form for your desire.

LIGHT WHERE YOU WANT IT

The luminaire is available either with direct light only or also with additional indirect light.

NOT ONLY SYMMETRICAL

An asymmetrical light distribution is possible thanks to a special foil.

DIFFERENT COLOURS

The housing is available in RAL 9005 black, RAL 9006 silver and RAL 9016 white – RAL of your choice on demand.

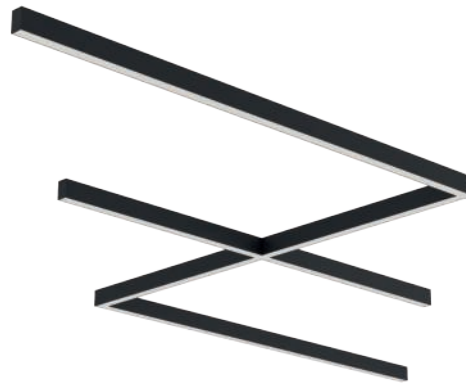

LINE50hex

LINE50 as hexagon or square shape with welded corners in 3 sizes each are already included in the standard portfolio.



LINE50quad



LINE50

ÜBERSICHT | OVERVIEW | VUE D'ENSEMBLE

ANBAULEUCHE | SURFACE MOUNTED LUMINAIRE | LUMINAIRE EN SAILLIE

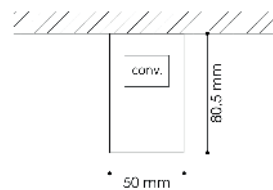

HÄNGELEUCHE | PENDANT LUMINAIRE | SUSPENSION

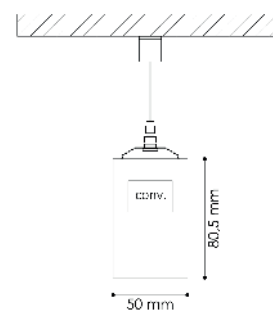
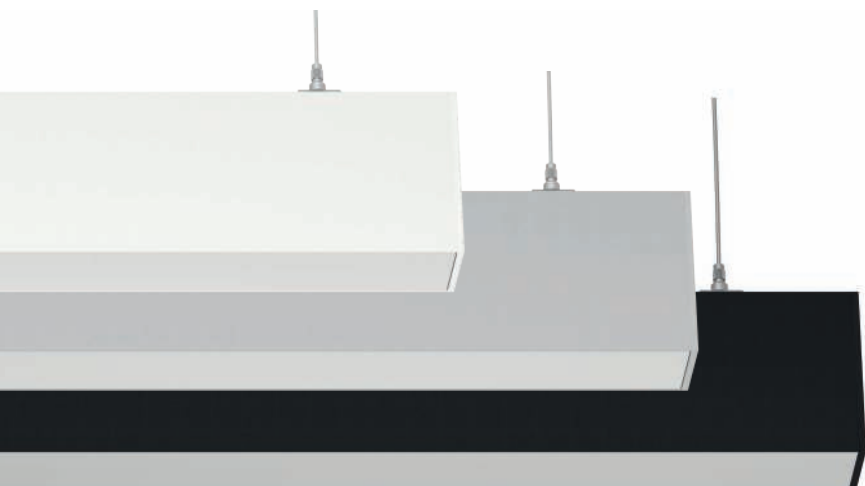

LINE50

ÜBERSICHT | OVERVIEW | VUE D'ENSEMBLE

WANDLEUCHE | WALL LUMINAIRE | APPLIQUE MURALE

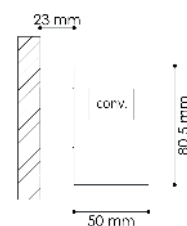
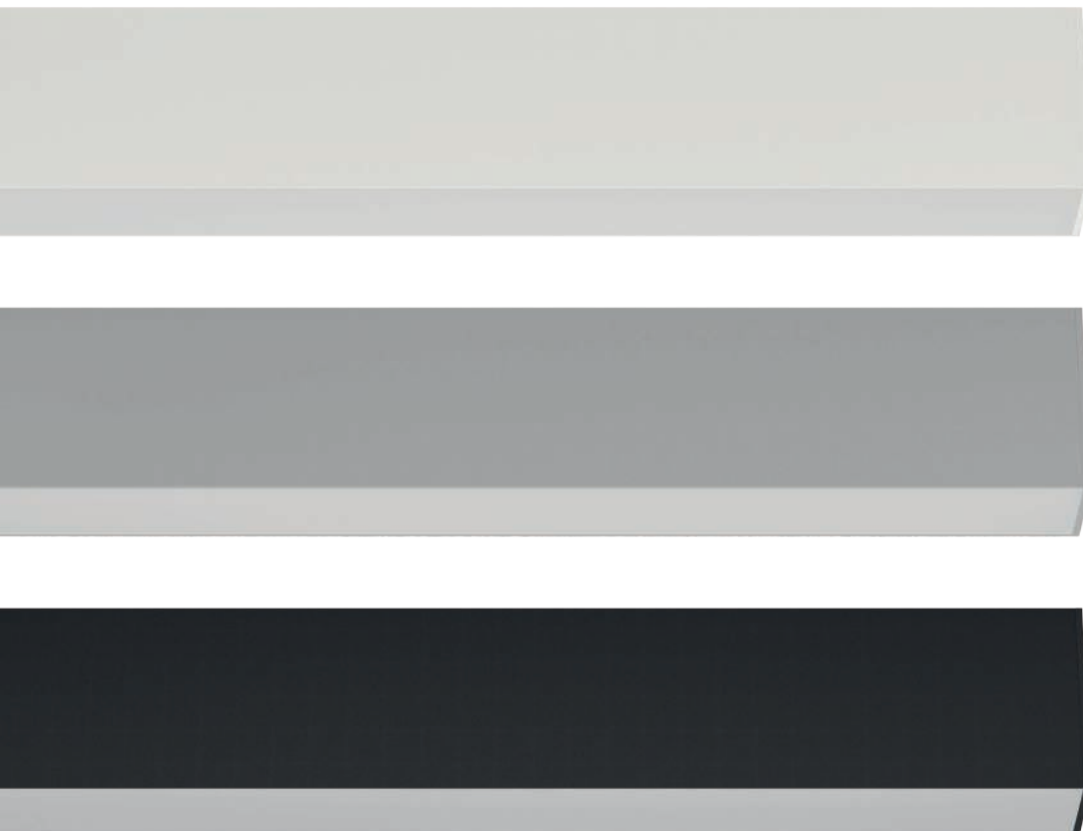

EINBAULEUCHE | RECESSED LUMINAIRE | LUMINAIRE ENCASTRABLE

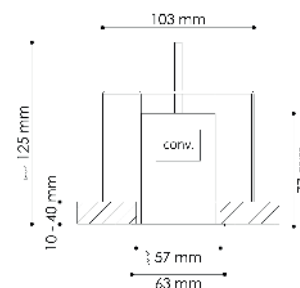

LINE50hex

ÜBERSICHT | OVERVIEW | VUE D'ENSEMBLE

ANBAULEUCHTE | SURFACE MOUNTED LUMINAIRE | LUMINAIRE EN SAILLIE

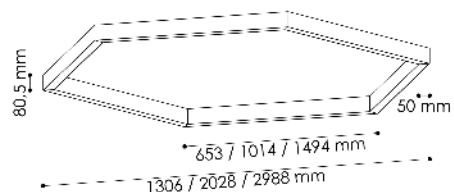

HÄNGELEUCHTE | PENDANT LUMINAIRE | SUSPENSION

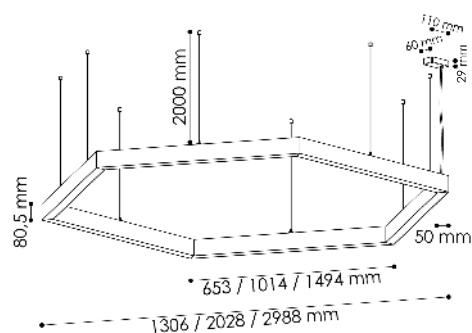



LINE50quad

ÜBERSICHT | OVERVIEW | VUE D'ENSEMBLE

ANBAULEUCHTE | SURFACE MOUNTED LUMINAIRE | LUMINAIRE EN SAILLIE

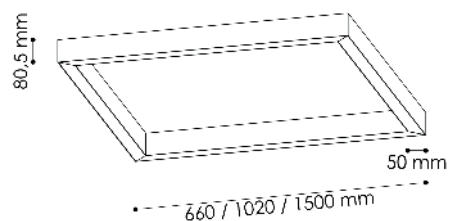

HÄNGELEUCHTE | PENDANT LUMINAIRE | SUSPENSION

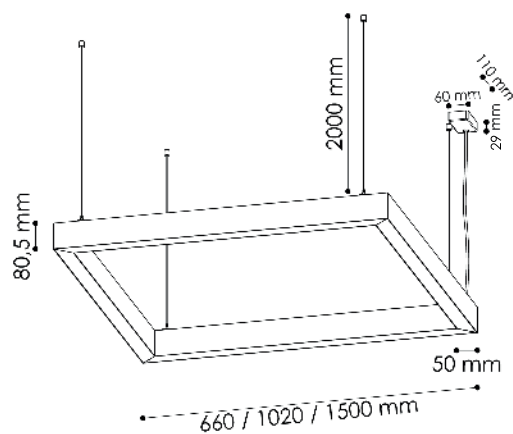





LINE50splash

HIGH EFFICIENCY

The high luminous output at low power provides an energy efficient luminaire – up to 130 lm/W.

3 MOUNTING VERSIONS

The luminaire is available as surface-mounted, recessed or pendant luminaire.

DIFFERENT COLOURS

The housing is available in RAL 9005 black, RAL 9006 silver and RAL 9016 white – RAL of your choice on demand.

INCREASED PROTECTION TYPE

Our profile in IP54 rated luminaires offer reliable protection against moisture, splash water, dust and dirt particles.

DYNAMIC WHITE

Besides the unicoloured colour temperatures dynamic white (2700K-6500K) is also available.

MAKE YOUR WISHES COME TRUE

An including emergency light or many other options are available on demand.



LINE50splash

ÜBERSICHT | OVERVIEW | VUE D'ENSEMBLE

ANBAULEUCHE | SURFACE MOUNTED LUMINAIRE | LUMINAIRE EN SAILLIE

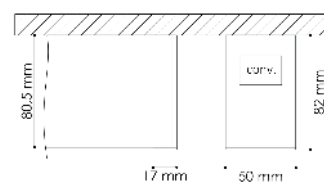
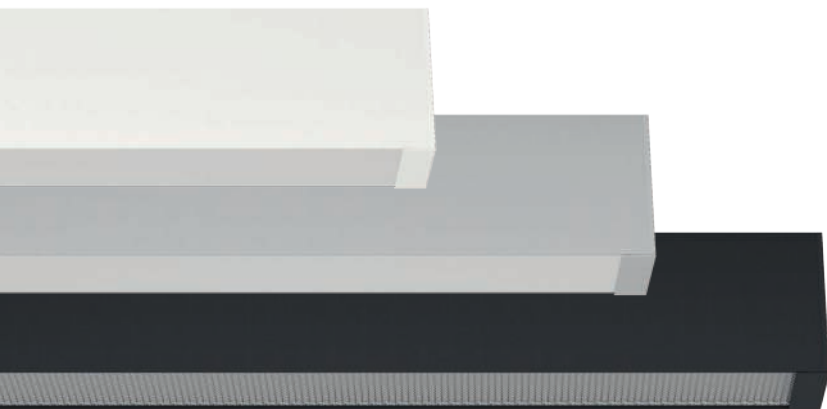

HÄNGELEUCHE | PENDANT LUMINAIRE | SUSPENSION

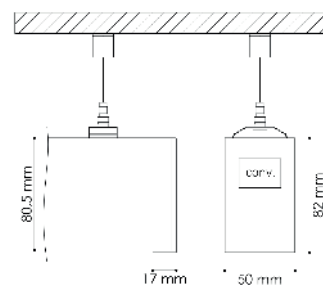
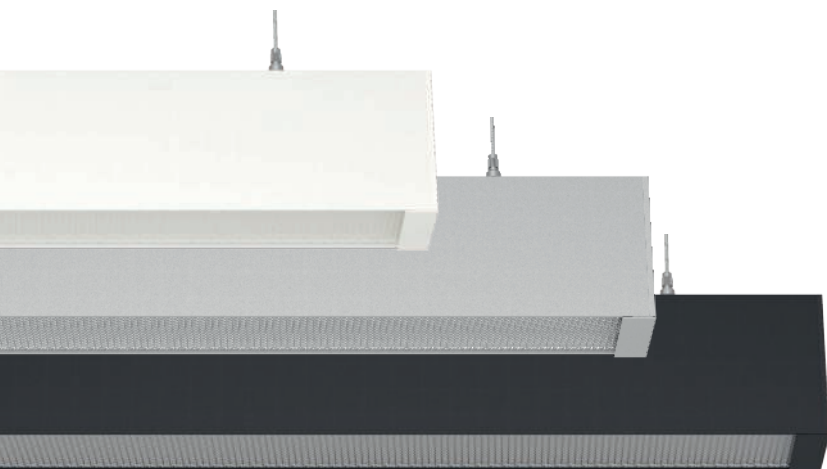

LINE50splash

ÜBERSICHT | OVERVIEW | VUE D'ENSEMBLE

EINBAULEUCHE | RECESSED LUMINAIRE | LUMINAIRE ENCASTRABLE

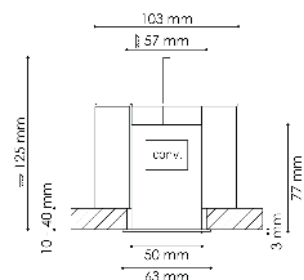



officeLINE50

HIGH EFFICIENCY

The high luminous output at low power provides an energy efficient luminaire – up to 162 lm/W.

3 MOUNTING VERSIONS

The luminaire is available as surface, pendant or recessed luminaire.

SENSOR

The 3 most common lengths of the pendant luminaire are also available with a sensor as standard.

PERFECT FOR YOUR WORK DESK

Special reflectors provide a glare-free light distribution (UGR<19).

LIGHT WHERE YOU WANT IT

The luminaire is available either with direct light only or also with additional indirect light.

DYNAMIC WHITE

Besides the unicoloured colour temperatures, dynamic white (2700K–6500K) is also available.

MAKE YOUR WISH COME TRUE

An including sensor, emergency light or many other options are available on demand.

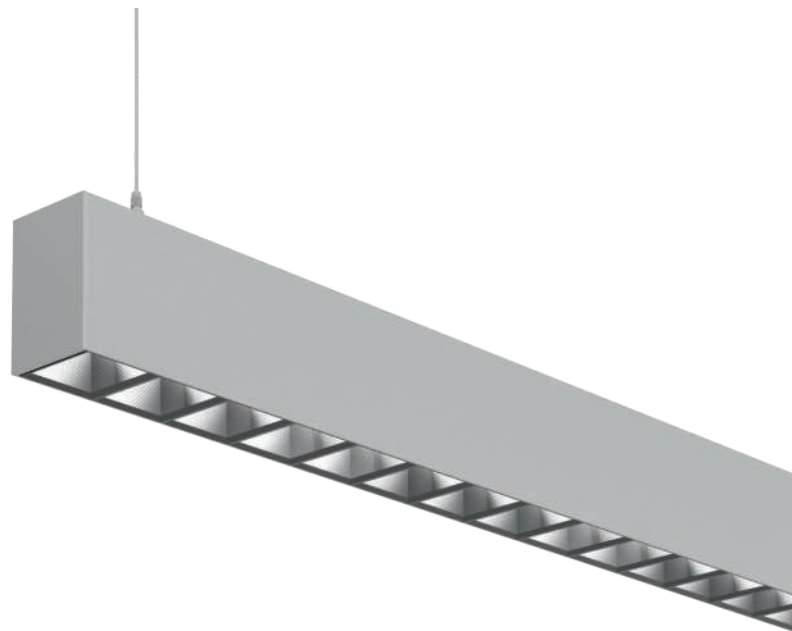

SOMETHING FOR EVERY TASTE

- 7 different reflector colours and finishes
- 3 different housing colours
- RAL of your choice for the housing on demand

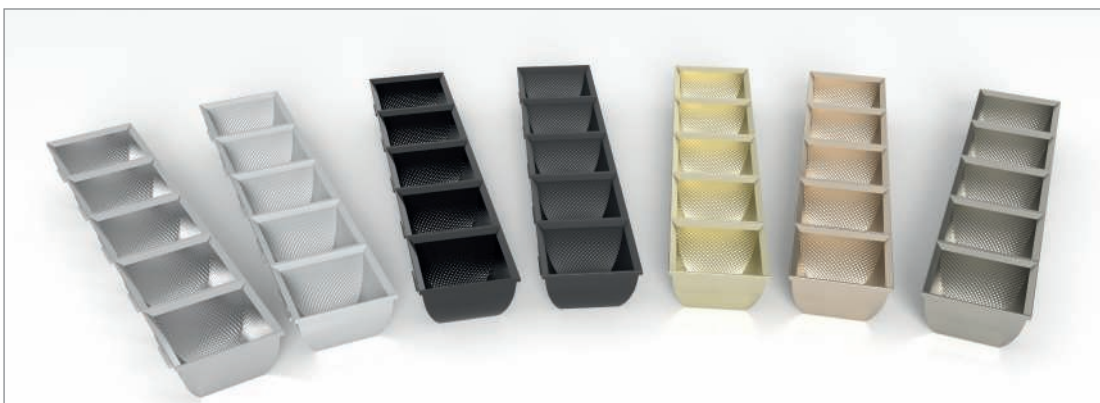

officeLINE50

ÜBERSICHT | OVERVIEW | VUE D'ENSEMBLE

ANBAULEUCHE | SURFACE MOUNTED LUMINAIRE | LUMINAIRE EN SAILLIE

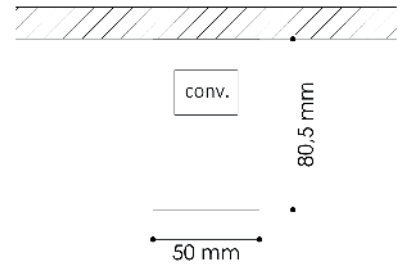
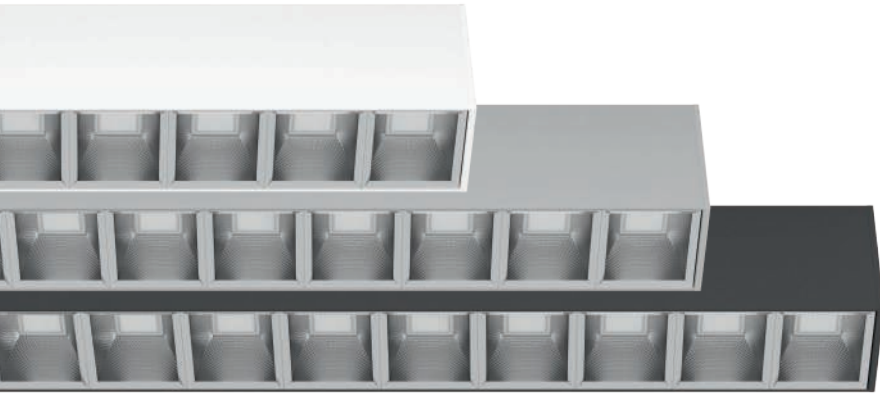

EINBAULEUCHE | RECESSED LUMINAIRE | LUMINAIRE ENCASTRABLE

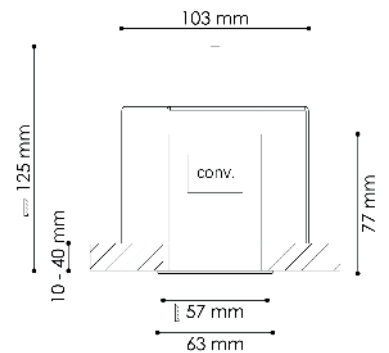
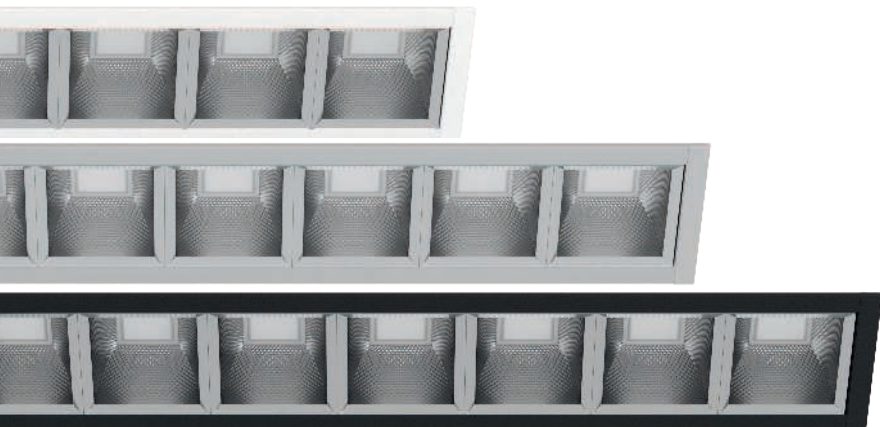

officeLINE50

ÜBERSICHT | OVERVIEW | VUE D'ENSEMBLE

HÄNGELEUCHE | PENDANT LUMINAIRE | SUSPENSION

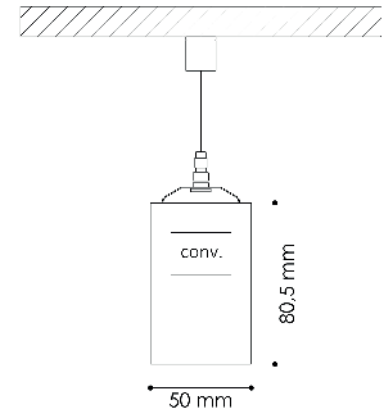
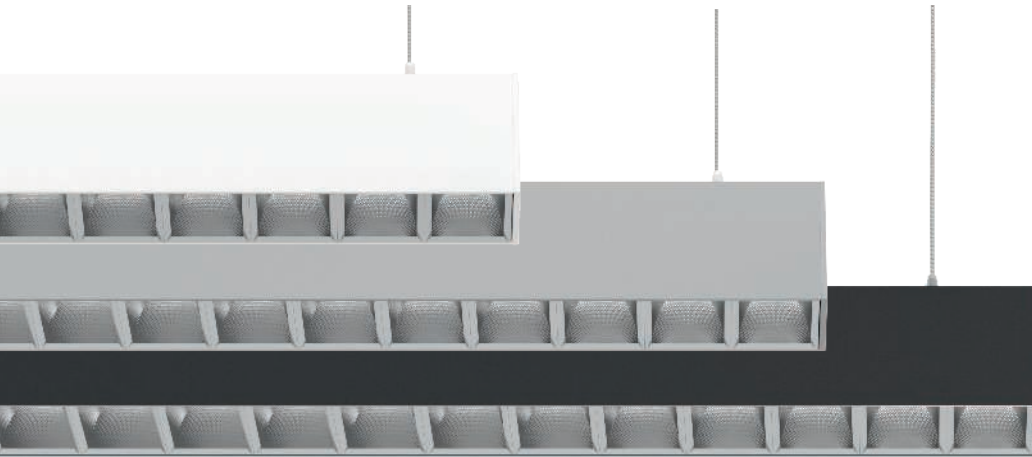

HÄNGELEUCHE MIT SENSOR | PENDANT LUMINAIRE WITH SENSOR | LUMINAIRE SUSPENDOU AVEC CAPTEUR

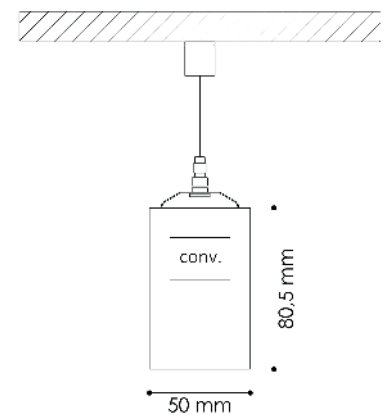



asymmetric
light distribution

Light where you need it!

officeLINE50free

HIGH EFFICIENCY

The high luminous output at low power provides an energy efficient luminaire – up to 141 lm/W.

2 VERSIONS

The luminaire is available as free-stand or as desk-mounted luminaire.

WIDE ILLUMINATION

Selectable between a single head version for double workstations or a double head version for quadruple workstations.

UNICOLOUR VERSION

The luminaire is available either with dimming option via touchpanel only or also with additional moving- and daylight sensor.

DYNAMIC WHITE

Besides the unicoloured colour temperatures dynamic white (2700K-6500K) is also available.

PERFECT FOR YOUR WORK DESK

Special reflectors provide a glare-free light distribution (UGR<19).

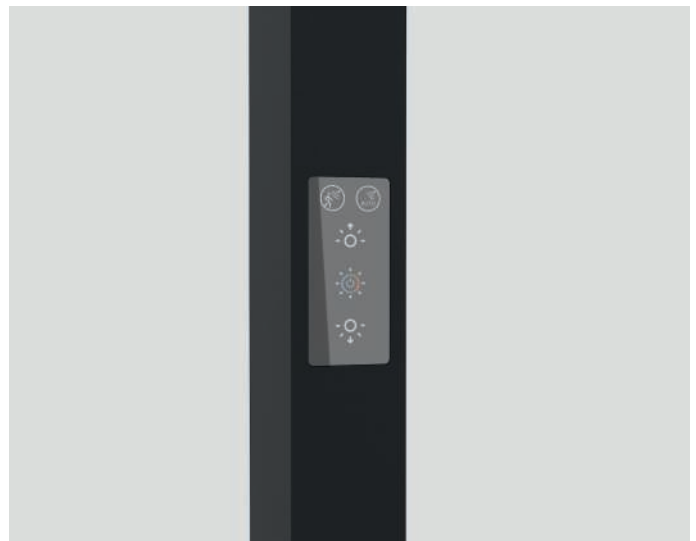

SOMETHING FOR EVERY TASTE

- 7 different reflector colours and finishes
- 3 different housing colours
- RAL of your choice for the housing on demand

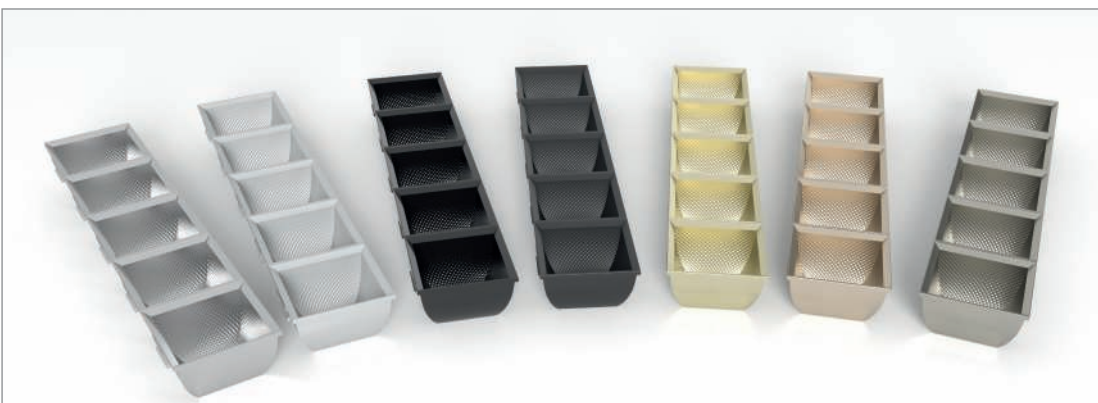

officeLINE50free

ÜBERSICHT | OVERVIEW | VUE D'ENSEMBLE

STEHLEUCHTE | FREE-STAND | LAMPADAIRE

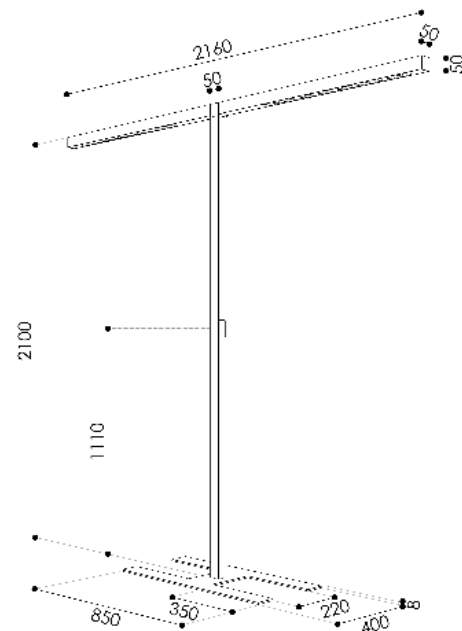
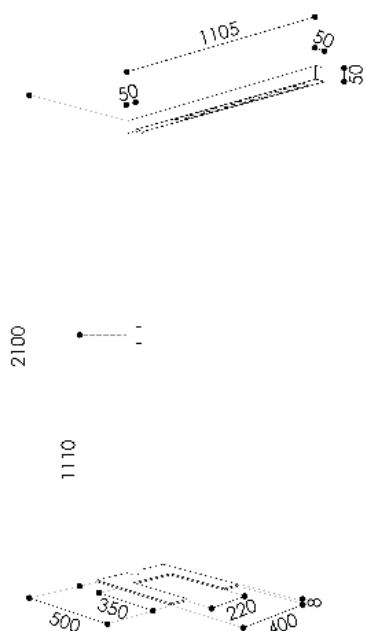
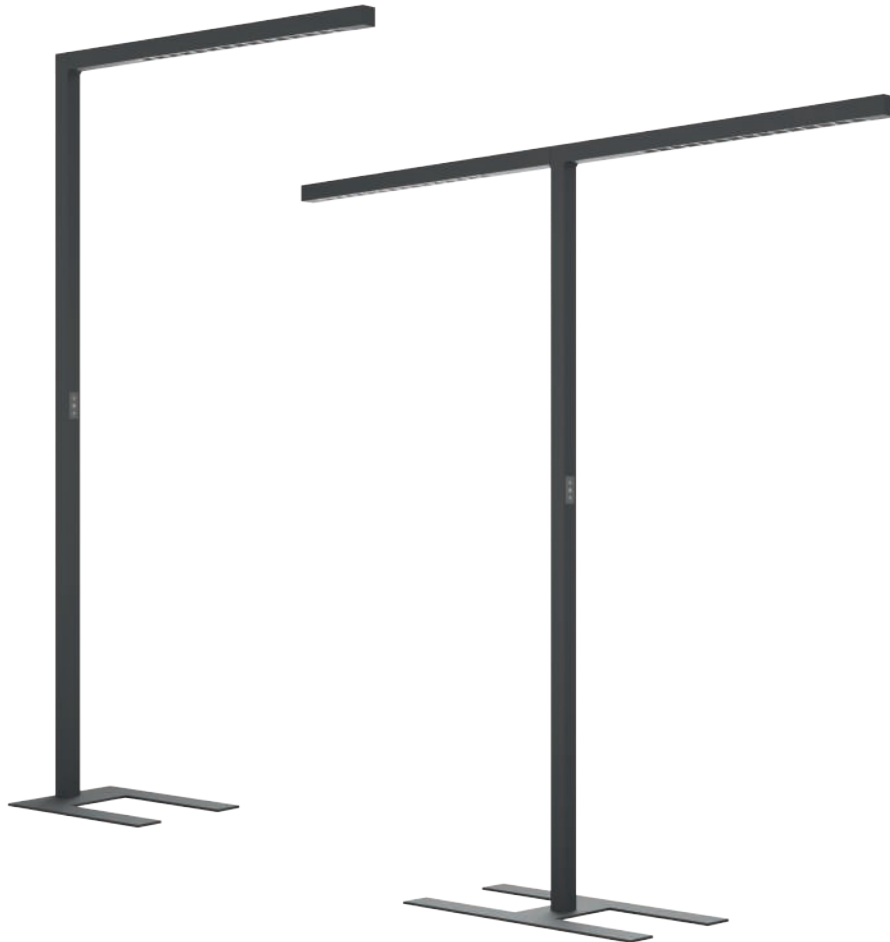

officeLINE50free

ÜBERSICHT | OVERVIEW | VUE D'ENSEMBLE

TISCHKLEMMLEUCHE | DESK-MOUNTED LUMINAIRE | LUMINAIRE MONTAGE SUR TABLE

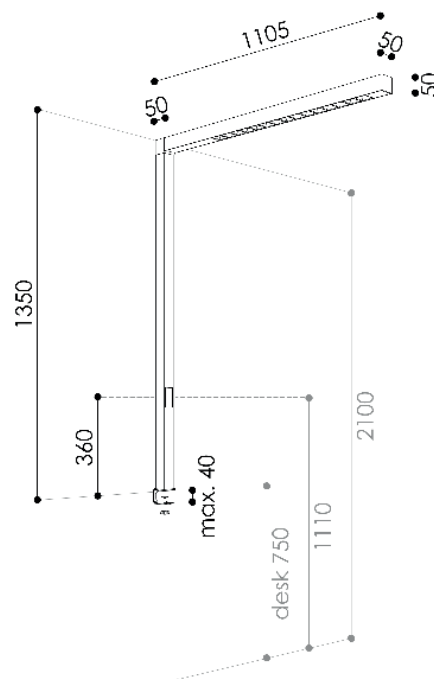
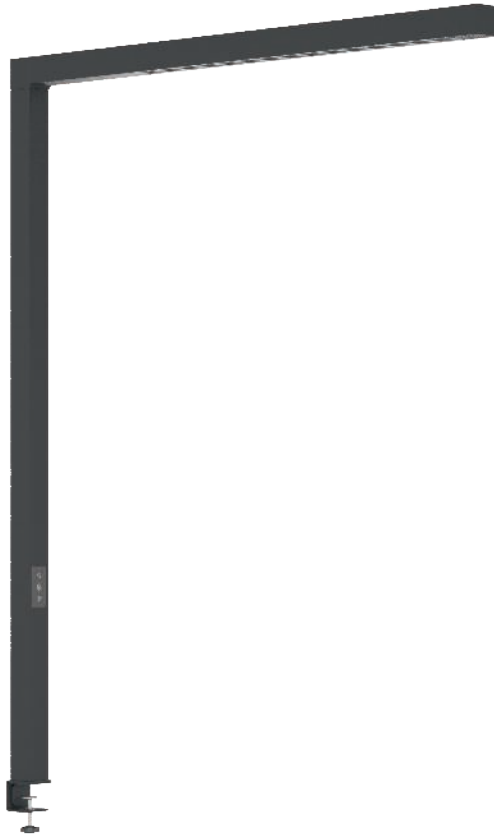



LINE70

HIGH EFFICIENCY

The high luminous output at low power provides an energy efficient luminaire – up to 161 lm/W.

4 MOUNTING VERSIONS

The luminaire is available as surface, pendant, recessed or wall luminaire.

DIFFERENT COLOURS

The housing is available in RAL 9005 black, RAL 9006 silver and RAL 9016 white – RAL of your choice on demand.

INDIVIDUAL SHAPES

Due to a modular system, we can make a special form for your desire.

LIGHT WHERE YOU WANT IT

The luminaire is available either with direct light only or also with additional indirect light.

DYNAMIC WHITE

Besides the unicoloured colour temperatures, dynamic white (2700K–6500K) is also available.

MAKE YOUR WISH COME TRUE

An including sensor, emergency light or many other options are available on demand.

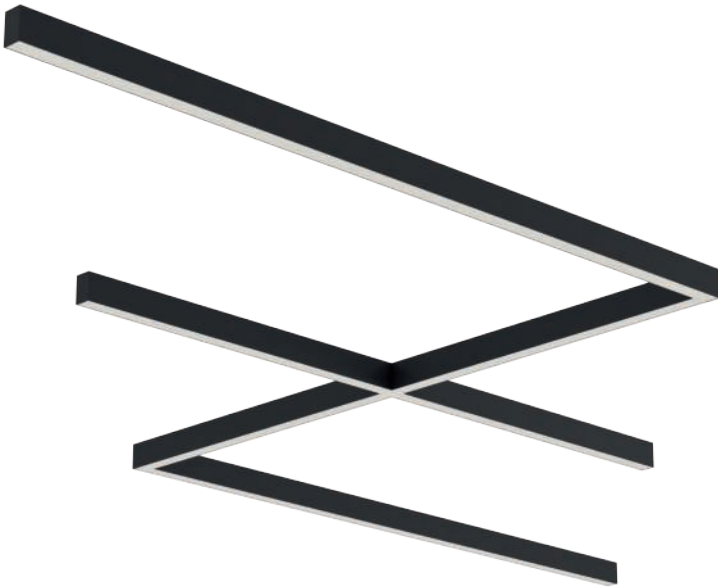

LINE70

ÜBERSICHT | OVERVIEW | VUE D'ENSEMBLE

ANBAULEUCHE | SURFACE MOUNTED LUMINAIRE | LUMINAIRE EN SAILLIE

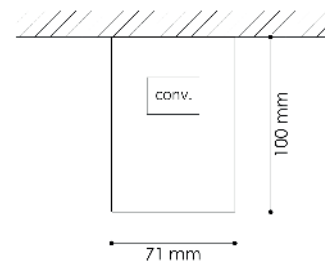

HÄNGELEUCHE | PENDANT LUMINAIRE | SUSPENSION

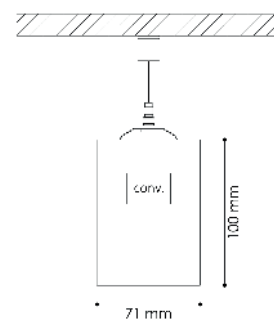
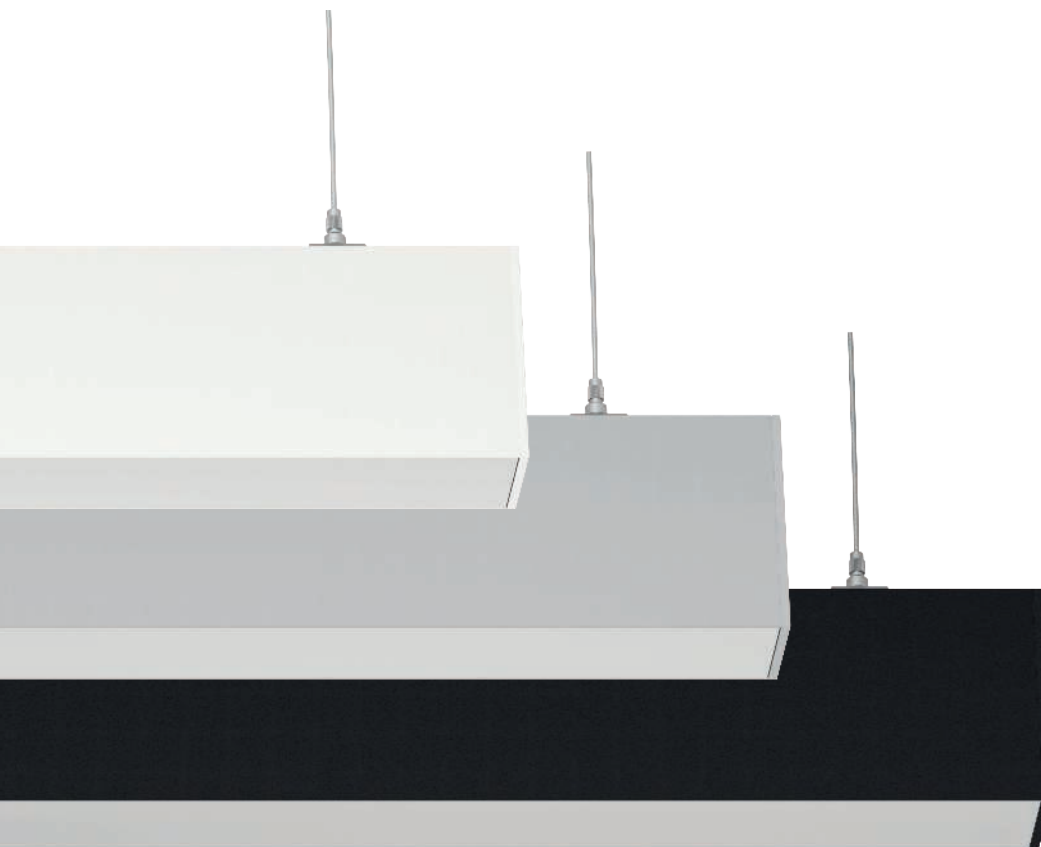

LINE70

ÜBERSICHT | OVERVIEW | VUE D'ENSEMBLE

WANDLEUCHE | WALL LUMINAIRE | APPLIQUE MURALE

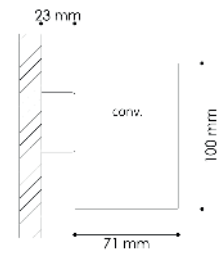
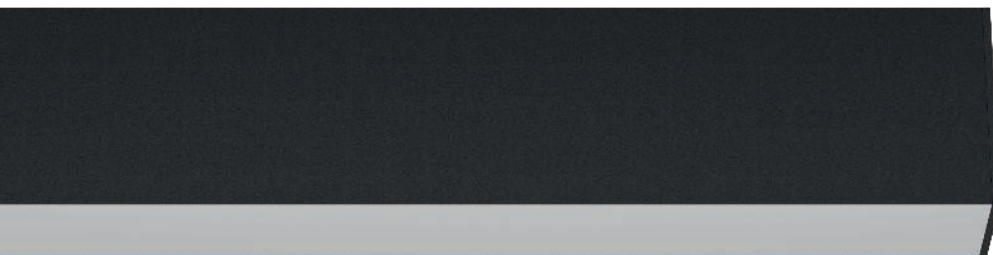
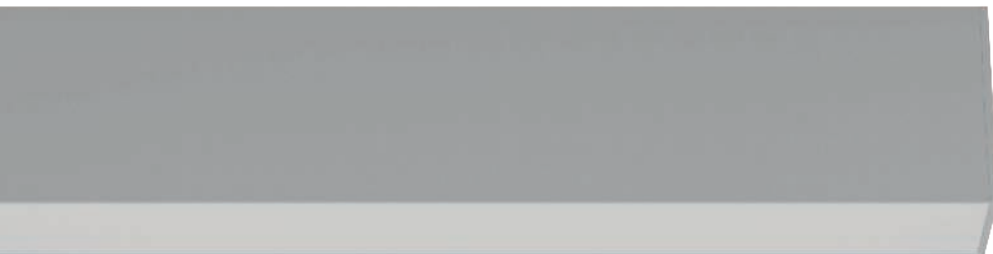

EINBAULEUCHE | RECESSED LUMINAIRE | LUMINAIRE ENCASTRABLE

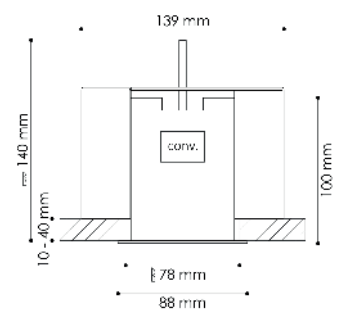
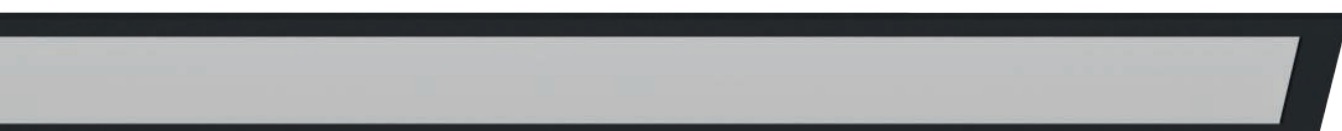
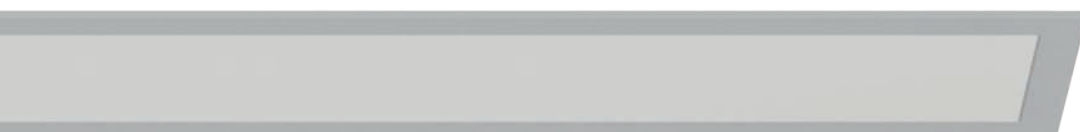
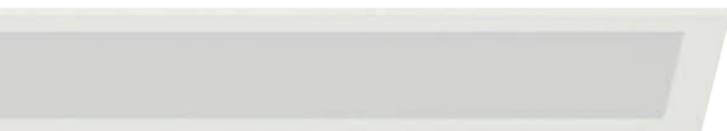



RING50

HIGH EFFICIENCY

The high luminous output at low power provides an energy efficient luminaire – up to 136 lm/W.

3 MOUNTING VERSIONS

The luminaire is available as surface, pendant or recessed luminaire.

DIFFERENT COLOURS

The housing is available in RAL 9005 black, RAL 9006 silver and RAL 9016 white – RAL of your choice on demand.

LARGE SELECTION OF SIZES

The luminaire is available in 9 different diameters.

LIGHT WHERE YOU WANT IT

The luminaire is available either with direct light only or also with additional indirect light.

DYNAMIC WHITE

Besides the unicoloured colour temperatures, dynamic white (2700K–6500K) is also available.

MAKE YOUR WISH COME TRUE

An including emergency light or many other options are available on demand.



RING50

ÜBERSICHT | OVERVIEW | VUE D'ENSEMBLE

ANBAULEUCHE | SURFACE MOUNTED LUMINAIRE | LUMINAIRE EN SAILLIE

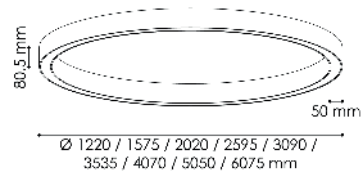

HÄNGELEUCHE | PENDANT LUMINAIRE | SUSPENSION



Code Standard: **H**

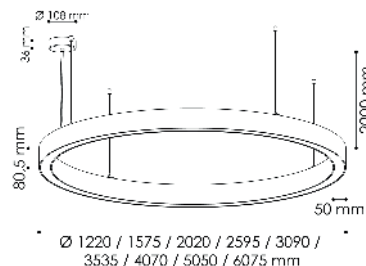

Code Central: **Z**

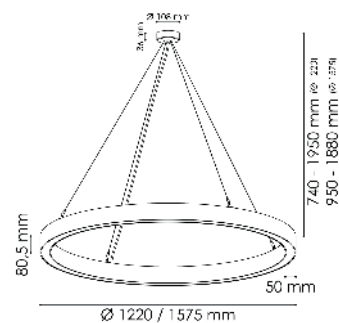

Code Y-Suspension: **Y**

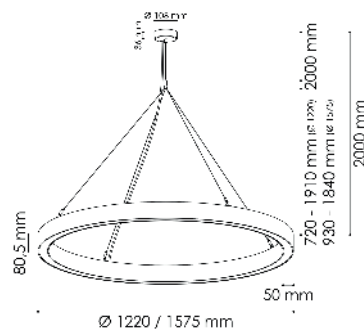

RING50

ÜBERSICHT | OVERVIEW | VUE D'ENSEMBLE

EINBAULEUCHE | RECESSED LUMINAIRE | LUMINAIRE ENCASTRABLE

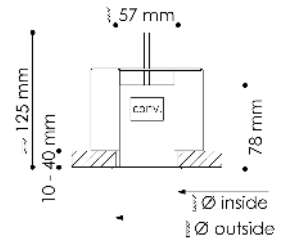
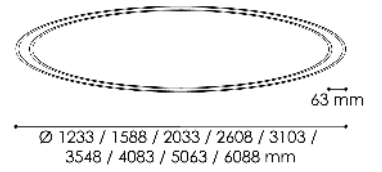
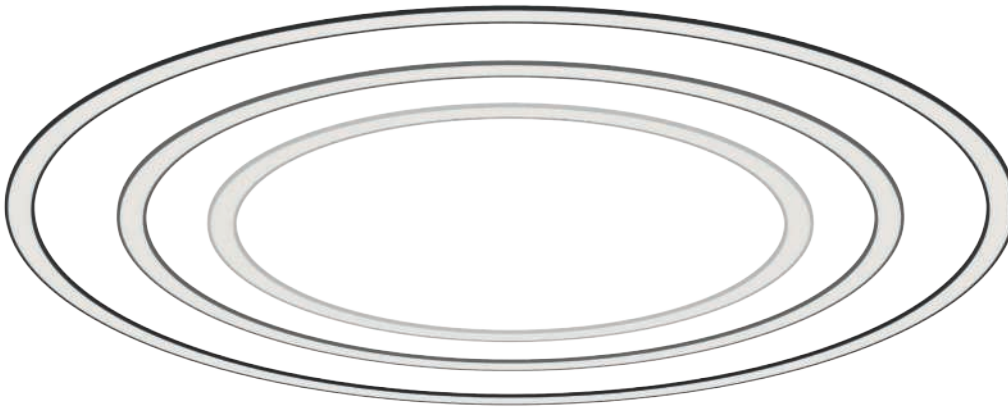



MUTE

SPECIAL SHAPES

Luminaires with acoustic panel version available as Quad, Hexagon or Ring.

2 MOUNTING VERSIONS

The luminaire is available as surface or pendant luminaire.

DIFFERENT COLOURS

The housing is available in RAL 9005 black, RAL 9006 silver and RAL 9016 white – RAL of your choice on demand.

HIGHEST QUALITY

The acoustic elements are acoustically tested in accordance with ISO 354.

LARGE VARIATION

The acoustic elements are available in black, light grey mottled, anthracite mottled, burgundy red and olive green.

ACOUSTIC MATERIAL

Made of at least 60% recycled PET.
Fire Classification B-s2, d0 (EN13501-1:3018).

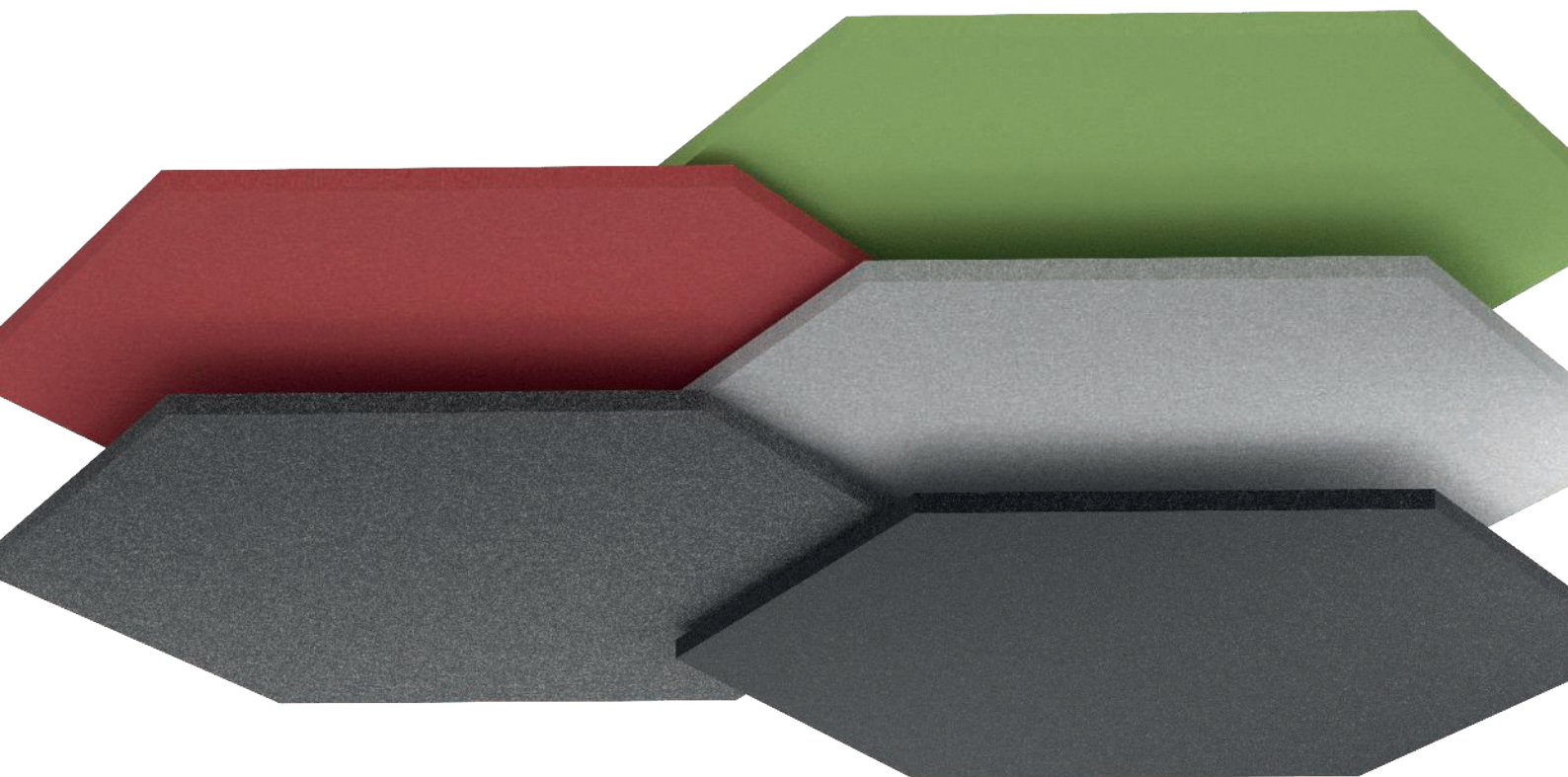

RING50mute

ÜBERSICHT | OVERVIEW | VUE D'ENSEMBLE

ANBAULEUCHE | SURFACE MOUNTED LUMINAIRE | LUMINAIRE EN SAILLIE

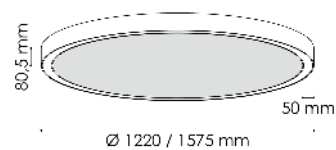
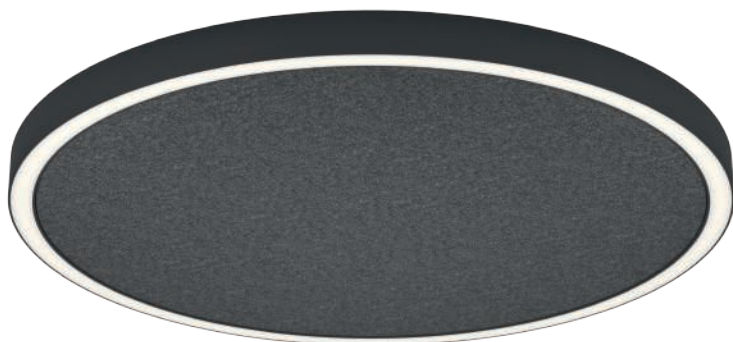

HÄNGELEUCHE | PENDANT LUMINAIRE | SUSPENSION

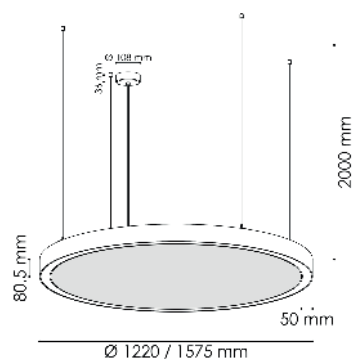

LINE50HEXmute

ÜBERSICHT | OVERVIEW | VUE D'ENSEMBLE

ANBAULEUCHTE | SURFACE MOUNTED LUMINAIRE | LUMINAIRE EN SAILLIE

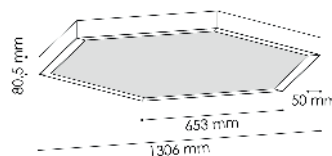

HÄNGELEUCHTE | PENDANT LUMINAIRE | SUSPENSION

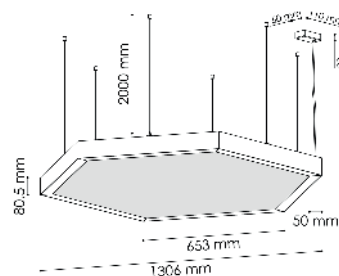
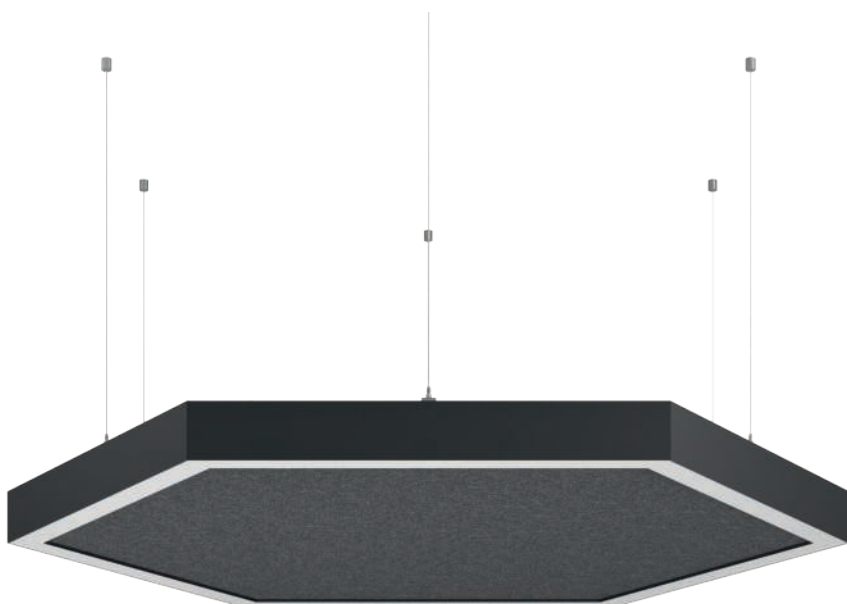

LINE50QUADmute

ÜBERSICHT | OVERVIEW | VUE D'ENSEMBLE

ANBAULEUCHE | SURFACE MOUNTED LUMINAIRE | LUMINAIRE EN SAILLIE

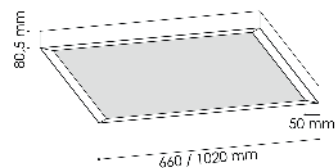

HÄNGELEUCHE | PENDANT LUMINAIRE | SUSPENSION

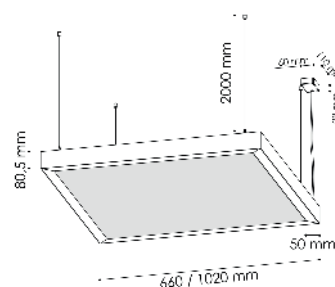
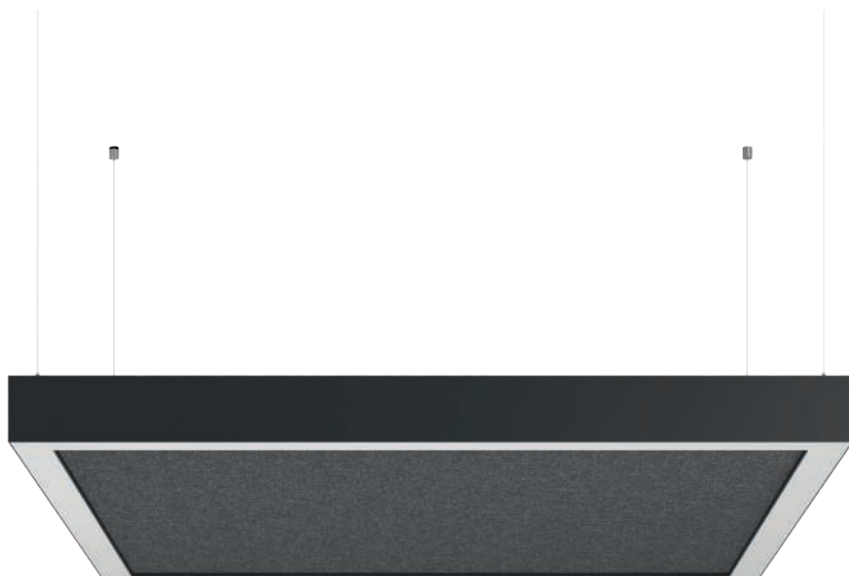





FLEX50

HIGH EFFICIENCY

The high luminous output at low power provides an energy efficient luminaire – up to 136 lm/W.

3 MOUNTING VERSIONS

The luminaire is available as surface, pendant or recessed luminaire.

DIFFERENT COLOURS

The housing is available in RAL 9005 black, RAL 9006 silver and RAL 9016 white – RAL of your choice on demand.

LARGE SELECTION OF SIZES

With 13 different segments – curved and straight – you can create nearly any shape.

LIGHT WHERE YOU WANT IT

The luminaire is available either with direct light only or also with additional indirect light.

DYNAMIC WHITE

Besides the unicoloured colour temperatures, dynamic white (2700K–6500K) is also available.

MAKE YOUR WISH COME TRUE

An including emergency light or many other options are available on demand.



FLEX50

ÜBERSICHT | OVERVIEW | VUE D'ENSEMBLE

ANBAULEUCHTE | SURFACE MOUNTED LUMINAIRE | LUMINAIRE EN SAILLIE

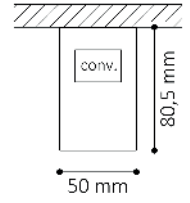

HÄNGELEUCHE | PENDANT LUMINAIRE | SUSPENSION

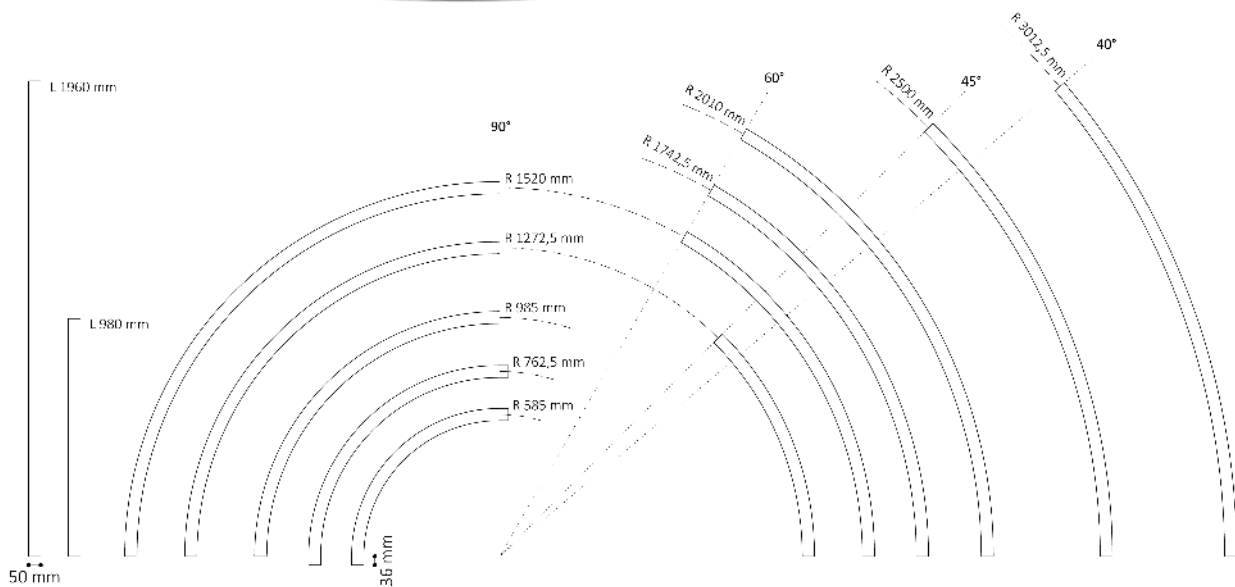
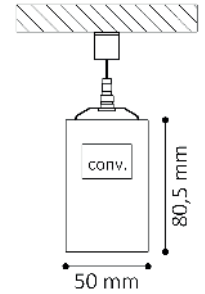

FLEX50

ÜBERSICHT | OVERVIEW | VUE D'ENSEMBLE

EINBAULEUCHE | RECESSED LUMINAIRE | LUMINAIRE ENCASTRABLE

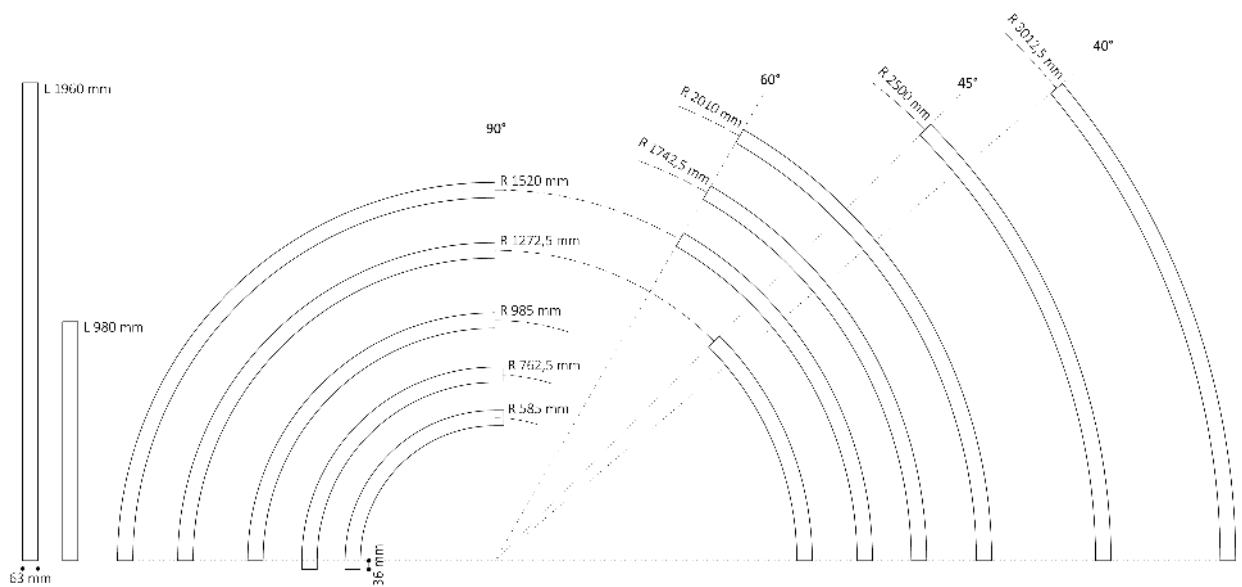
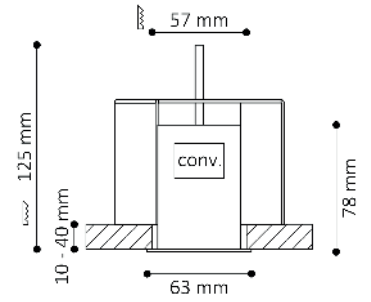

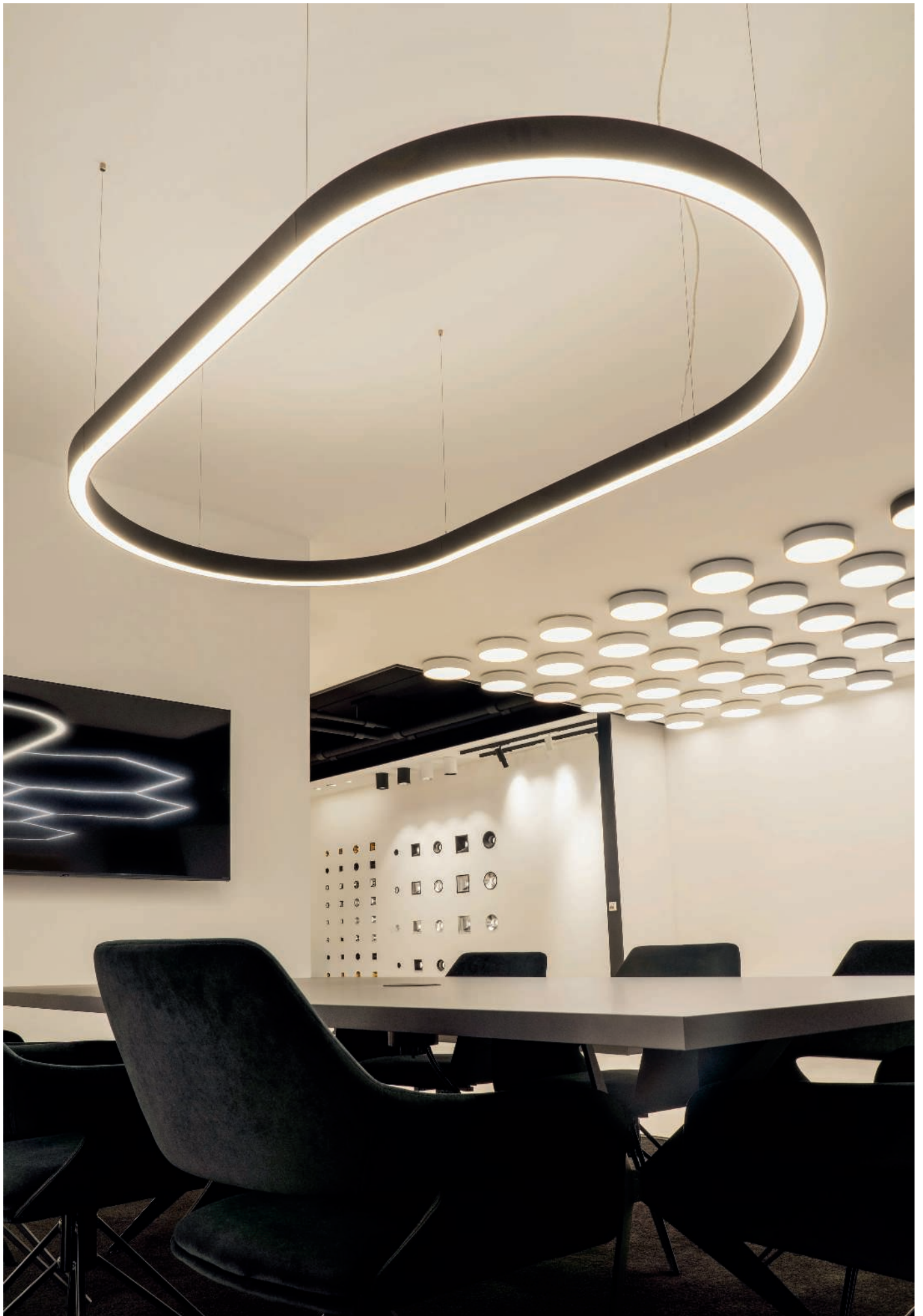

OVOID50

HIGH EFFICIENCY

The high luminous output at low power provides an energy efficient luminaire – up to 120 lm/W.

2 MOUNTING VERSIONS

The luminaire is available as surface-mounted or pendant luminaire.

DIFFERENT COLOURS

The housing is available in RAL 9005 black, and RAL 9016 white – RAL of your choice on demand.

LIGHT WHERE YOU WANT IT

The luminaire is available either with direct light only or also with additional indirect light.

DYNAMIC WHITE

Besides the unicoloured colour temperatures dynamic white (2700K-6500K) is also available.

MAKE YOUR WISHES COME TRUE

An including emergency light or many other options are available on demand.

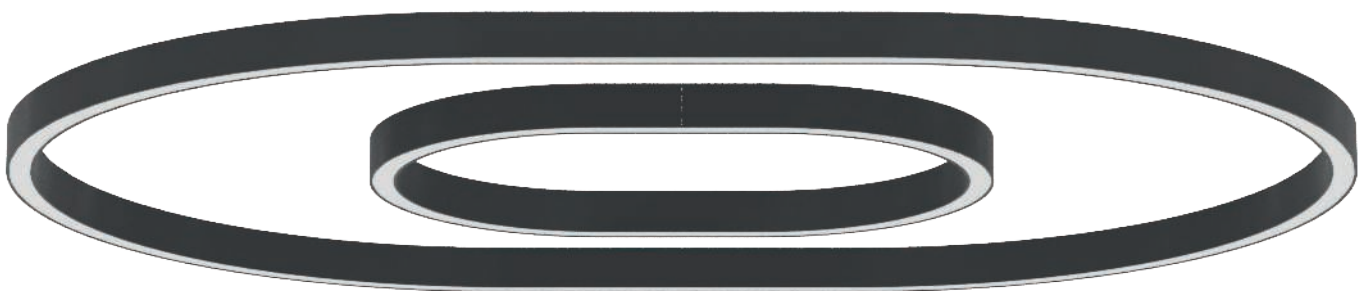

OVOID50

ÜBERSICHT | OVERVIEW | VUE D'ENSEMBLE

ANBAULEUCHE | SURFACE MOUNTED LUMINAIRE | LUMINAIRE EN SAILLIE

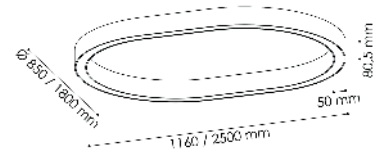

HÄNGELEUCHE | PENDANT LUMINAIRE | SUSPENSION

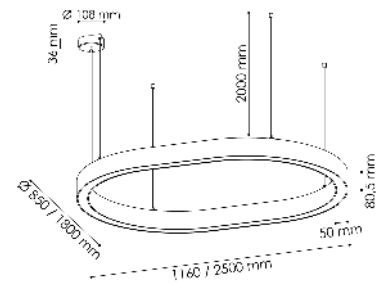
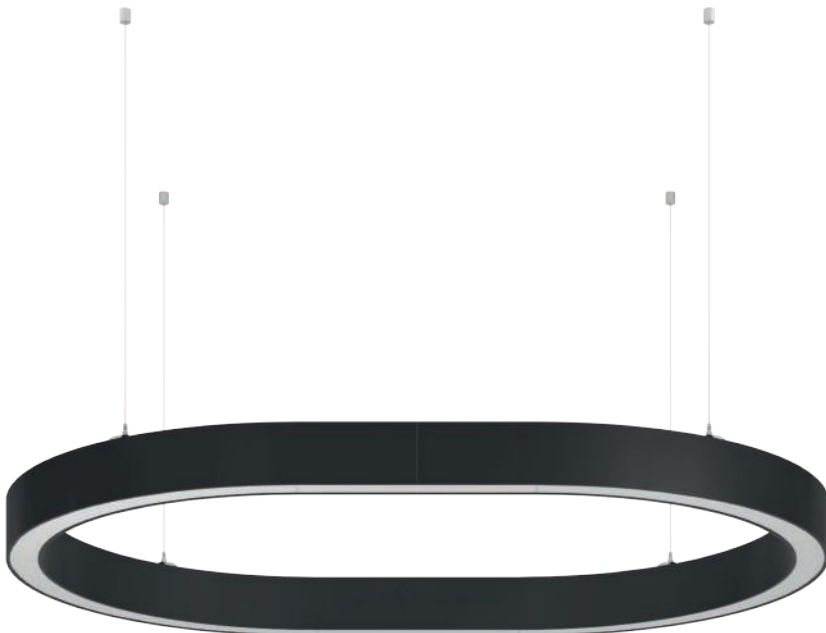





ROUND90

HIGH EFFICIENCY

The high luminous output at low power provides an energy efficient luminaire - up to 174 lm/W.

SLIDE & LIGHT

Simply sliding the housing into the canopy allows an easy installation of the surface luminaire.

NO INSECTS – NO PROBLEMS

With an IP50 rating, the luminaire housing is protected against insects and dust.

MAKE YOUR WISH COME TRUE

Besides the unicoloured colour temperatures, dynamic white (2700K–6500K) is also available.

LIGHT WHERE YOU WANT IT

The luminaire is available either with direct light only or also with additional indirect light.

ROTATE & FIX

The recessed luminaire can be fixed easily into the mounting frame by inserting and rotating

DYNAMIC WHITE

Besides the unicoloured colour temperatures, dynamic white (2700K–6500K) is also available.

4 DIFFERENT SIZES 4 DIFFERENT SUSPENSION TYPES



KEEP IT SIMPLE BUT MAKE IT UNIQUE

- 3 different housing colours
- 6 different decoration ring colours
- RAL colour of your choice on demand



ROUND90

ÜBERSICHT | OVERVIEW | VUE D'ENSEMBLE

ANBAULEUCHTE | SURFACE MOUNTED LUMINAIRE | LUMINAIRE EN SAILLIE

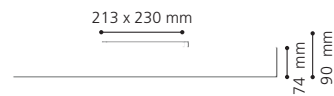

DIRECT

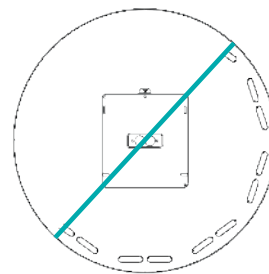

DIRECT + INDIRECT

Ø 350 / 450 / 650 / 950 mm

WANDLEUCHTE | WALL LUMINAIRE | APPLIQUE MURALE



DIRECT

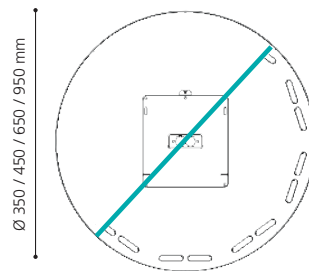

DIRECT + INDIRECT

Ø 350 / 450 / 650 / 950 mm



EINBAULEUCHTE | RECESSED LUMINAIRE | LUMINAIRE ENCASTRABLE

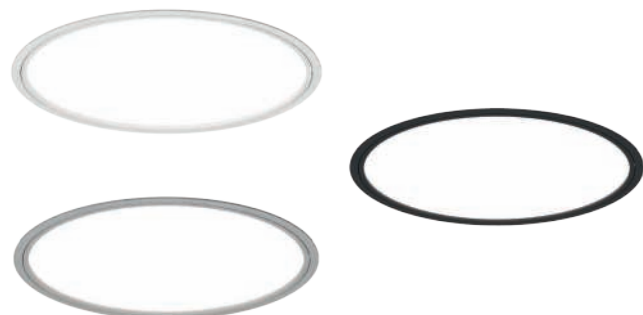

cutout Ø 368 / 468 / 668 / 968 mm

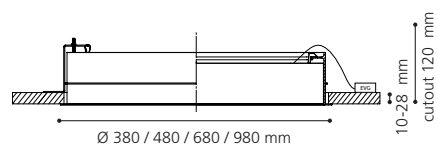

Ø 380 / 480 / 680 / 980 mm

ROUND90

ÜBERSICHT | OVERVIEW | VUE D'ENSEMBLE

HÄNGELEUCHE | PENDANT LUMINAIRE | SUSPENSION

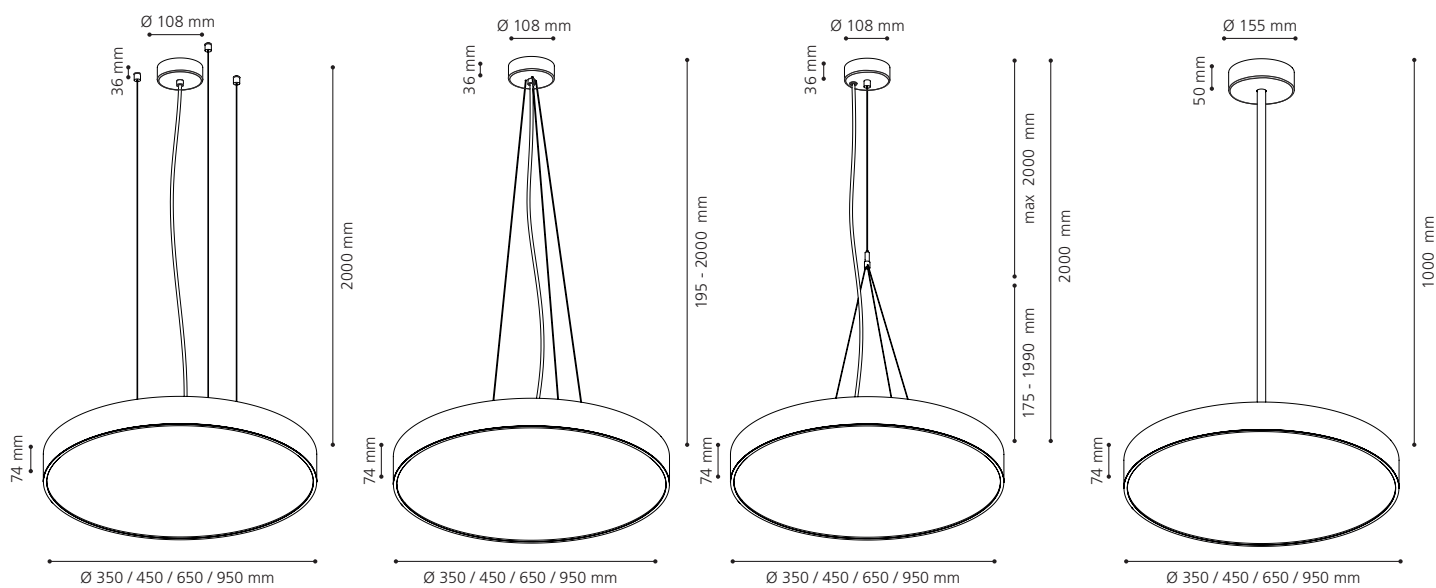



SQUARE90

HIGH EFFICIENCY

The high luminous output at low power provides an energy efficient luminaire - up to 175 lm/W.

SLIDE & LIGHT

Simply sliding the housing into the canopy allows an easy installation of the surface luminaire.

NO INSECTS – NO PROBLEMS

With an IP50 rating, the luminaire housing is protected against insects and dust.

LIGHT WHERE YOU WANT IT

The luminaire is available either with direct light only or also with additional indirect lighting.

DYNAMIC WHITE

Besides the unicoloured colour temperatures, dynamic white (2700K–6500K) is also available.

MAKE YOUR WISH COME TRUE

An including sensor, emergency light or many other options are available on demand.

4 DIFFERENT SIZES 4 DIFFERENT SUSPENSION TYPES

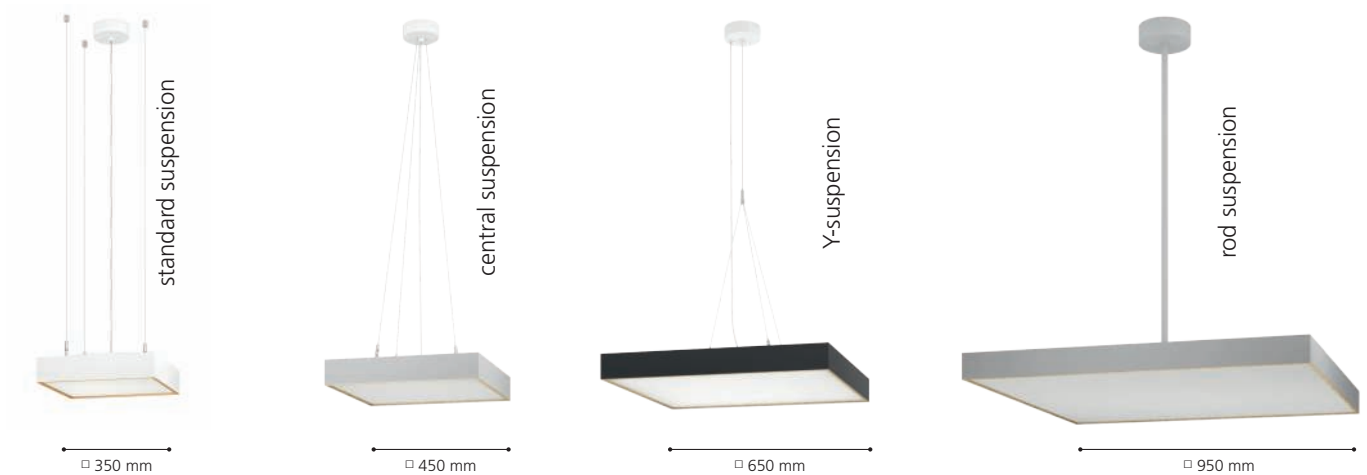

KEEP IT SIMPLE BUT MAKE IT UNIQUE

- 3 different housing colours
- 6 different decoration ring colours
- RAL colour of your choice on demand

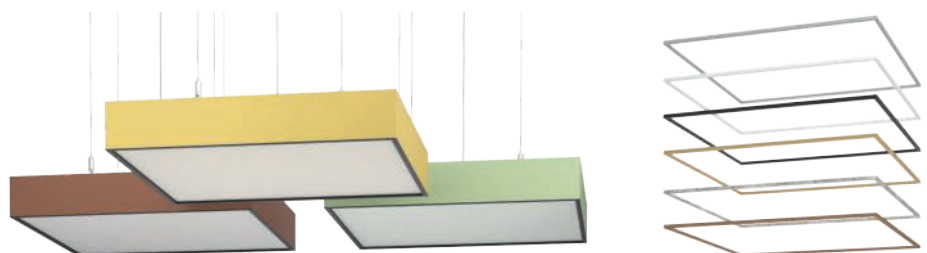

SQUARE90

ÜBERSICHT | OVERVIEW | VUE D'ENSEMBLE

ANBAULEUCHE | SURFACE MOUNTED LUMINAIRE | LUMINAIRE EN SAILLIE

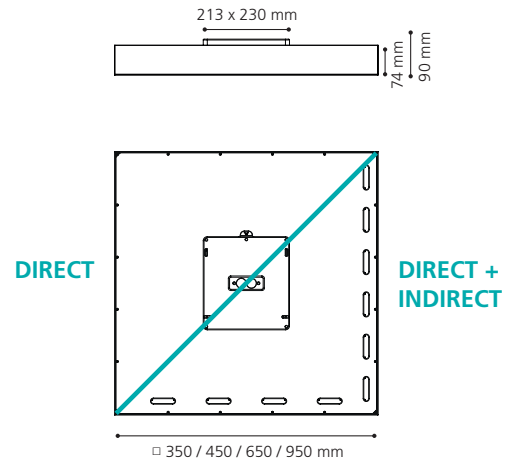
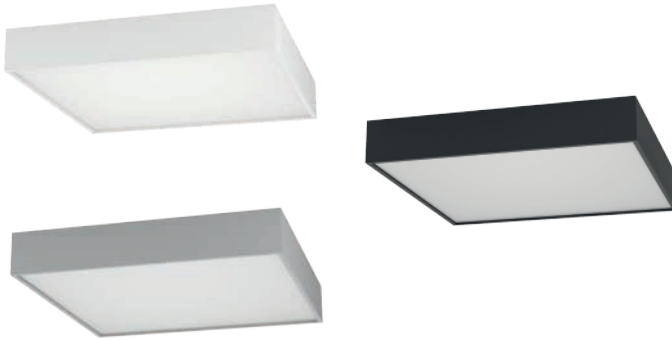

WANDLEUCHE | WALL LUMINAIRE | APPLIQUE MURALE

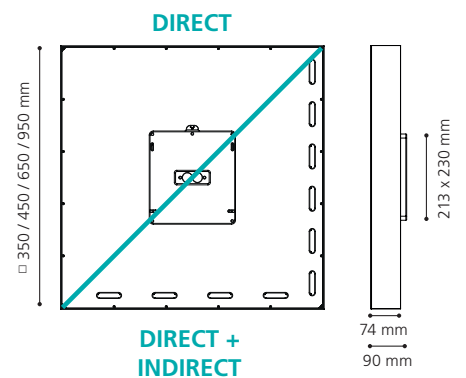

SQUARE90

ÜBERSICHT | OVERVIEW | VUE D'ENSEMBLE

HÄNGELEUCHE | PENDANT LUMINAIRE | SUSPENSION

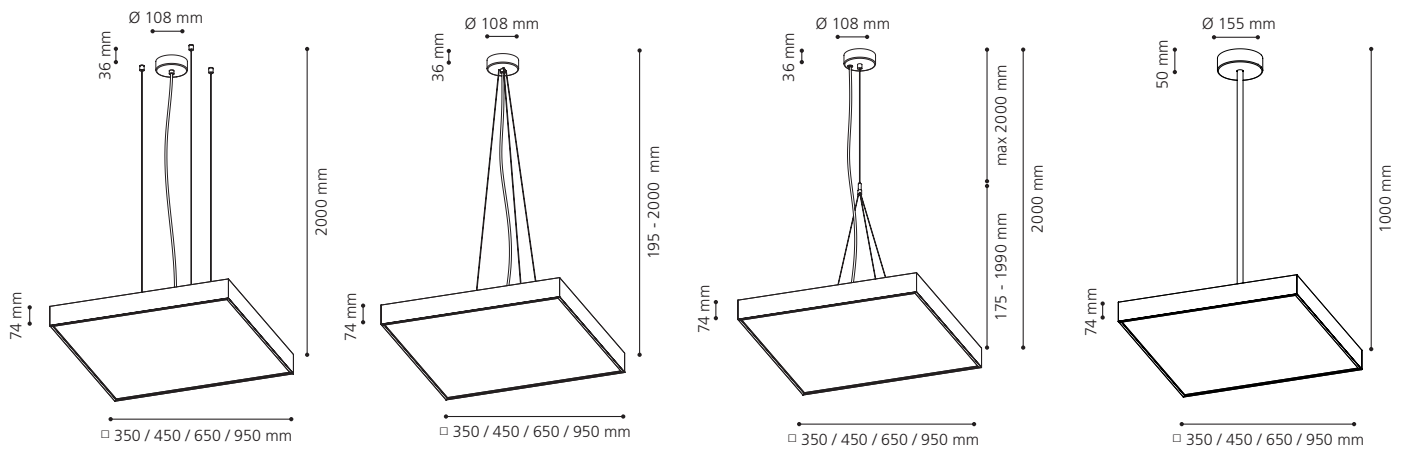



ROPE22

CREATE YOUR OWN LAYOUT

Various lengths from 1.2 to 10.0 meters are available to create the layout of your choice.

3 MOUNTING VERSIONS

ROPE22 includes a wide range of mounting accessories for surface, recessed and pendant installation.

DIFFERENT COLOURS

The accessories are available in RAL 9005 black, and RAL 9016 white or in anodized midnight blue, anthracite or gold finish.

HOMOGENEOUS ILLUMINATION

ROPE22 creates a uniformly illuminated lighting experience with a 360° beam characteristic.

THE RIGHT LIGHTING EXPERIENCE

With up to 1640 lm/m, the ROPE22 produced a powerful light output.

DRIVER OPTIONS

Select the required driver option from on/off or DALI drivers.





DOWN75

ROUND OR SQUARE?

The downlight is available either as a round or square shape.

POWERFUL SOLUTION

With up to 1341lm, DOWN75 offers the right solution for every project.

DIFFERENT COLOURS

The housing is available in RAL 9005 black, RAL 9006 silver and RAL 9016 white – RAL of your choice on demand.

SELECT THE RIGHT ANGLE

DOWN75 is available with beam angles of 23° and 45°.

THE RIGHT POWER LEVEL

DOWN75 is available in two different output levels - low output (63 mm height) and high output (87 mm height).

DRIVER OPTIONS

Select the required driver option from on/off, TRIAC or DALI drivers.





designDOT/SQOT

DOT OR SQOT?

The recessed spot is available either as a round or square shape.

DIFFERENT SIZES

For each shape there are 2 different sizes – 68 or 100 mm.

COLOUR VARIANTS

2 housing colours and 4 different reflector colours and finishes are available.

NOT ONLY SYMMETRICAL

The 100 mm size is also available with an asymmetric beam angle – round and square.

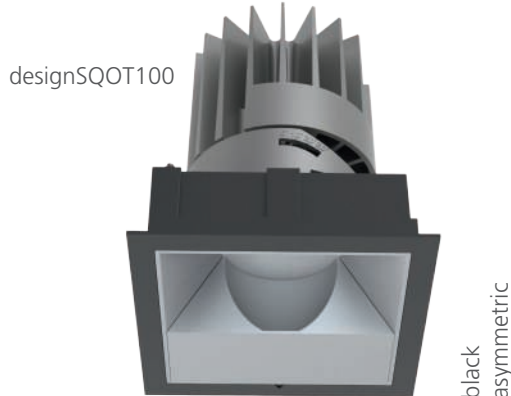
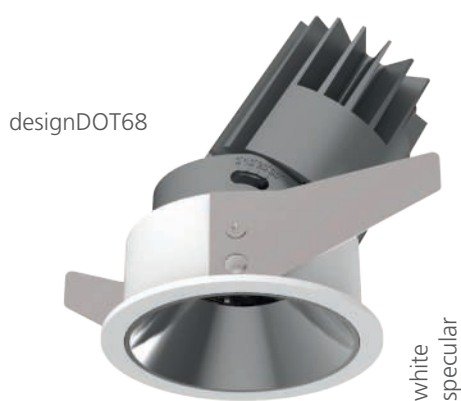

designDOT

ÜBERSICHT | OVERVIEW | VUE D'ENSEMBLE

designDOT68

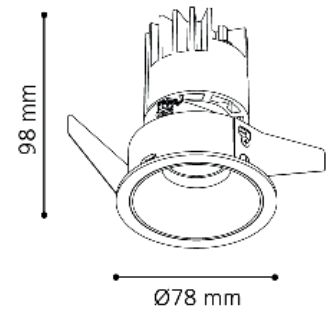

designDOT100

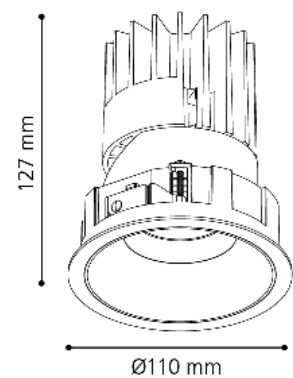

designSQOT

ÜBERSICHT | OVERVIEW | VUE D'ENSEMBLE

designSQOT68

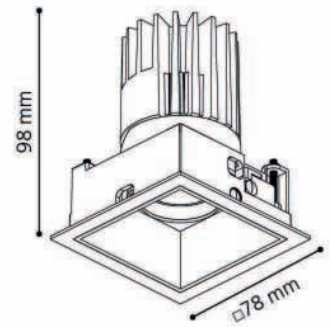
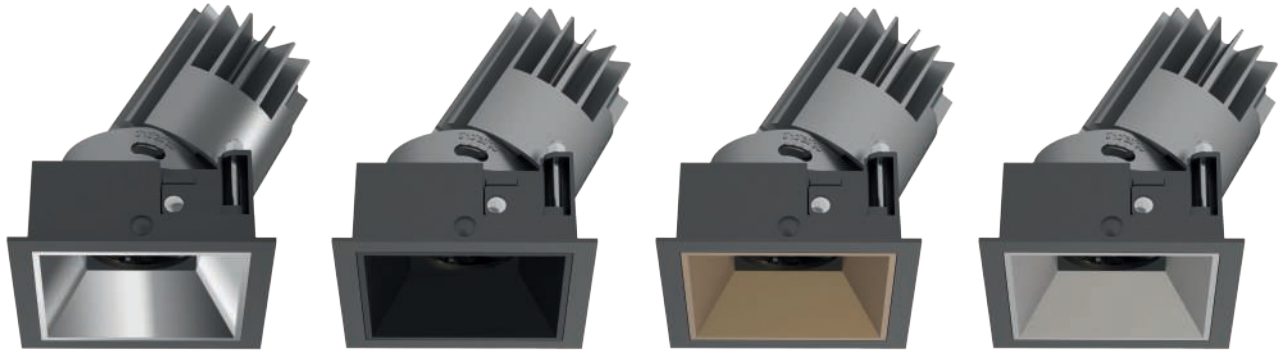

designSQOT100

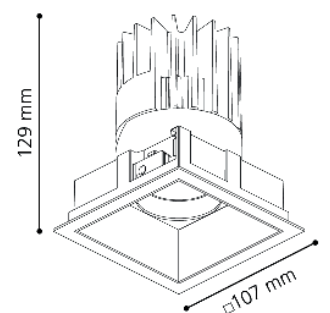
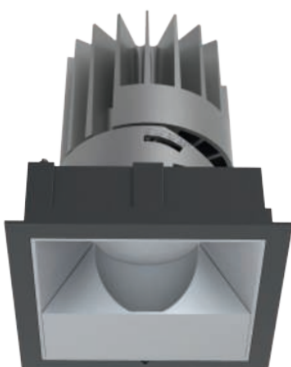
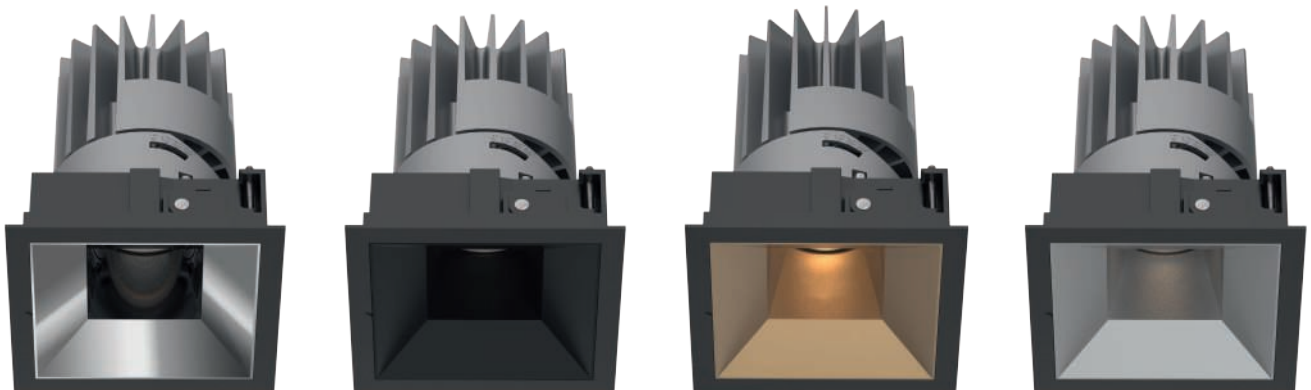



techDOT/SQOT

DOT OR SQOT?

The spot is available either as a round or square shape.

SURFACE VERSION

techDOT is also available as a surface spot with 151mm diameter.

COLOUR VARIANTS

2 housing colours and 2 different reflector colours are available.

DOT SIZES

The DOT recessed version is available in 3 different sizes – 75, 150 & 200 mm.

SQOT SIZES

The SQOT is available as recessed spot in 2 different sizes – 150 & 200 mm.

DYNAMIC WHITE 150 & 200 VERSION

Besides the unicoloured colour temperatures, dynamic white (2700K–6500K) is also available.



techDOT

ÜBERSICHT | OVERVIEW | VUE D'ENSEMBLE

techDOT75

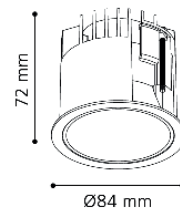

techDOT150

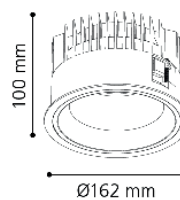

techDOT200

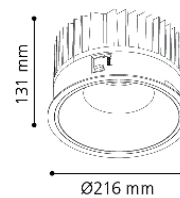

techDOT150surface

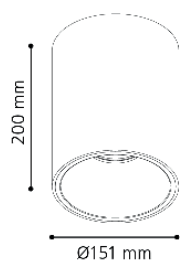

techSQOT

ÜBERSICHT | OVERVIEW | VUE D'ENSEMBLE

techSQOT150

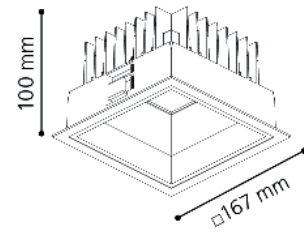

techSQOT200

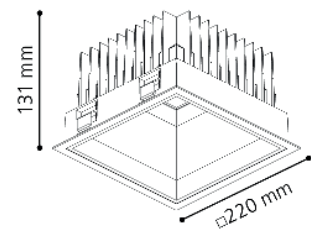



GLOW

ALL INTEGRATED

The rotatable, swivelling 3-phase track spotlights have an inTrack driver on/off or DALI.

POWERFUL SOLUTION

With a total of six sizes with up to 4.834lm, GLOW offers the right solution for every project.

DIFFERENT COLOURS

The housing is available in RAL 9005 black, and RAL 9016 white – RAL of your choice on demand.

GU10 VERSION AVAILABLE

Version with GU10 bulb in diameter Ø 90 mm with up to 655lm available.

LARGE VARIATION

The luminaire is equipped with a high-quality decoration ring with a choice of eight different colours – specular or matt.

THE MATCHING LIGHT

GLOWmedium, GLOWlarge and GLOWultra has special COBs for different areas like fashion, bakery, meat, etc....

GLOWmini



GLOWsmall



GLOWmedium



GLOWlarge



GLOWultra



GLOWgu10



GLOW

ÜBERSICHT | OVERVIEW | VUE D'ENSEMBLE

GLOWmini

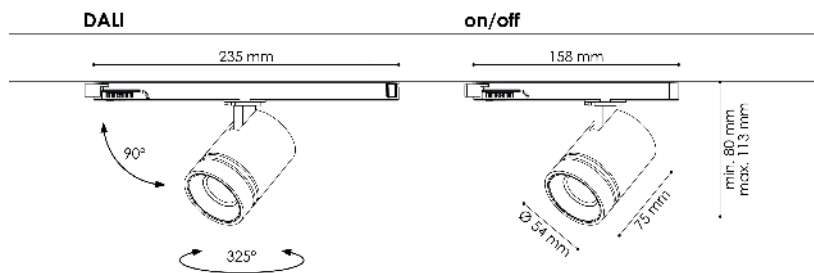

GLOW

ÜBERSICHT | OVERVIEW | VUE D'ENSEMBLE

GLOWsmall

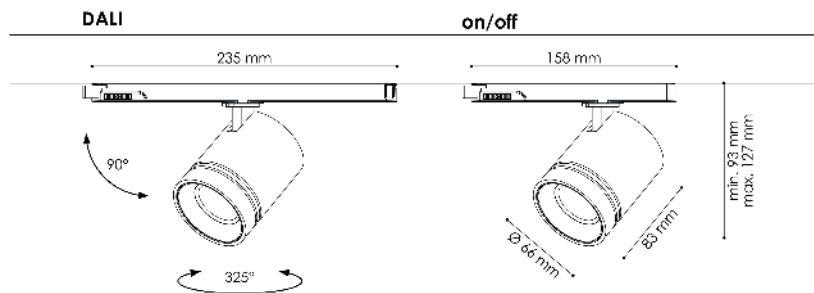

GLOW

ÜBERSICHT | OVERVIEW | VUE D'ENSEMBLE

GLOWmedium

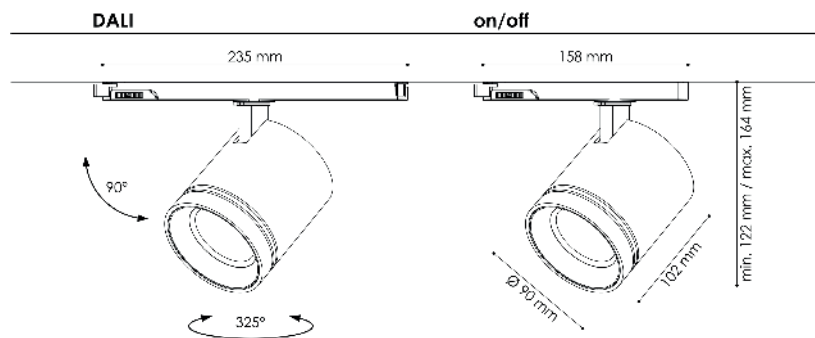

GLOW

ÜBERSICHT | OVERVIEW | VUE D'ENSEMBLE

GLOWlarge

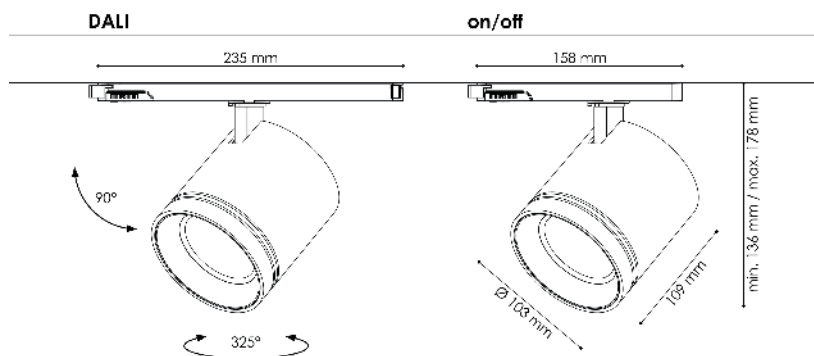

GLOW

ÜBERSICHT | OVERVIEW | VUE D'ENSEMBLE

GLOWultra

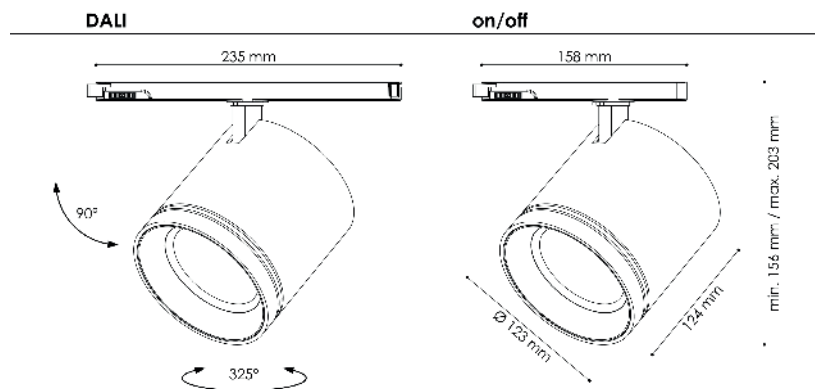

GLOW

ÜBERSICHT | OVERVIEW | VUE D'ENSEMBLE

GLOWgu10

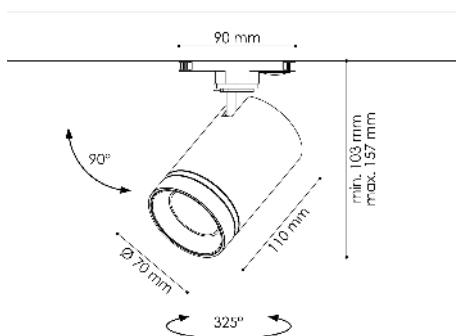



trackS/M

ALL INTEGRATED

The rotatable, swivelling 3-phase track spotlights have an inTrack adapter on/off or DALI.

NARROW OR WIDE

Different beam angles are available – 18°/36°/50° for trackS – 20°/55° for trackM.

SMALL OR MEDIUM

The 150 mm long spot head is either available with a diameter of 55 or 72 mm.

THE MATCHING LIGHT

trackM has special colour temperatures for different areas like fashion, bakery, meat, etc.

trackS



trackM



trackS



trackM



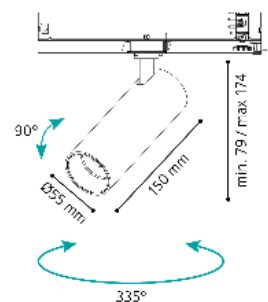

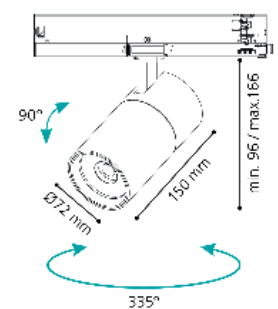

















OVERVIEW

ANBAULEUCHTEN | SURFACE MOUNTED LUMINAIRES | LUMINAIRES EN SAILLIE



LINE40
112



LINE50
114



LINE50hex
116



LINE50HEXmute
118



LINE50quad
120



LINE50QUADmute
122



LINE50splash
124



officeLINE50
126



LINE70
128



RING50
130



RING50mute
132



FLEX50
134



OVOID50
136



ROUND90
138



SQUARE90
140



techDOT150surface
142

ANBAULEUCHTEN

SURFACE MOUNTED LUMINAIRES

LUMINAIRES EN SAILLIE

LINE40

ANBAULEUCHTE | SURFACE MOUNTED LUMINAIRE | LUMINAIRE EN SAILLIE

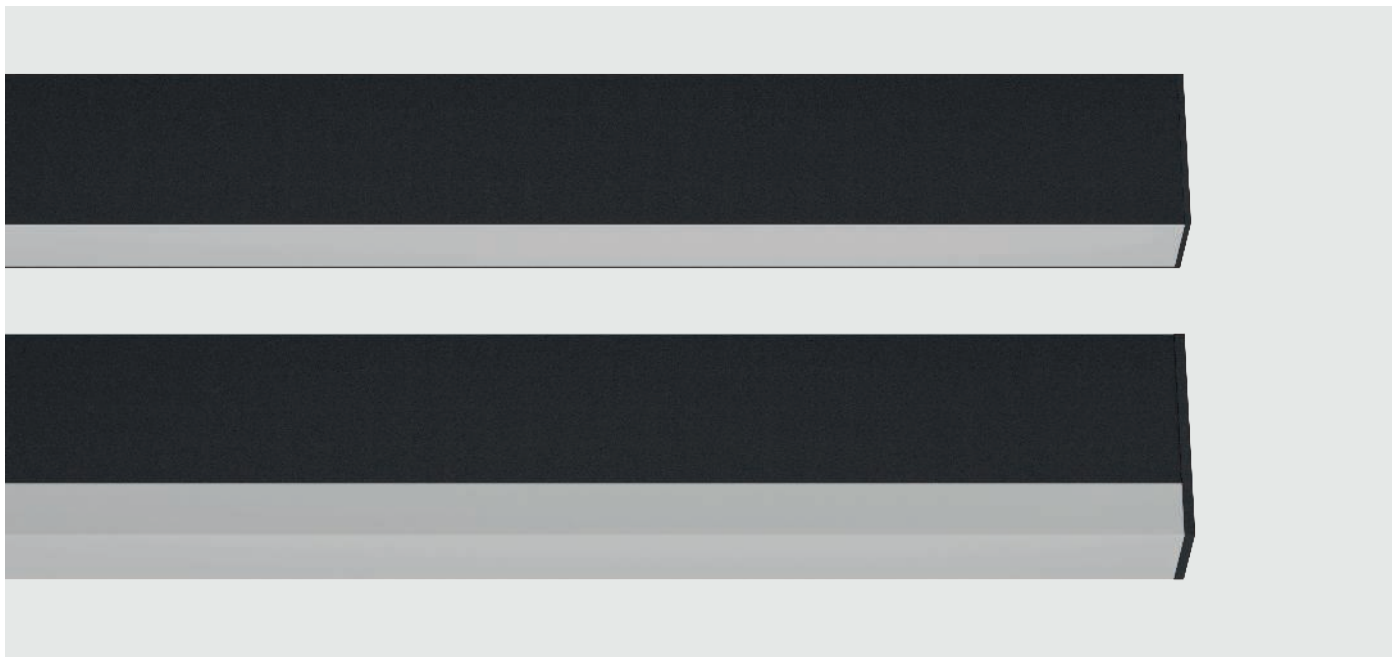

LED-Anbauleuchte direktstrahlend. Lichtkanal aus Aluminium-Strangpressprofil mit einer Breite von 41 mm. Fertigung der Leuchtenlänge millimetergenau auf Kundenwunsch möglich. Oberfläche der Leuchte feinstruktur matt pulverbeschichtet ähnlich RAL 9016 weiß, RAL 9006 silber oder RAL 9005 schwarz – auf Anfrage in RAL nach Wahl. Diffusor wahlweise in PMMA opal, PMMA opal U-Abdeckung oder PMMA klar mit eingeschobener mikroprismatischer Platte für eine reduzierte Leuchtdichte (UGR<19). Der LED-Treiber ist im Leuchtengehäuse integriert – wahlweise als on/off oder DALI-Variante. Farbtemperaturen 2700K, 3000K, 4000K oder dynamisch Weiß (2700K-6500K) – Farbwiedergabe CRI>80 oder CRI>90 – Mac Adam ≤3. Weitere Steuerungsoptionen oder Lichtfarben auf Anfrage erhältlich. Außerdem ist die Integration vieler Komponenten, wie beispielsweise Notlicht oder Sensortechnologie, sowie eine Vielzahl weiterer Optionen möglich.

Surface mounted LED luminaire with direct beam. Light channel made of extruded aluminium profile with a width of 41 mm. Luminaire length can be manufactured to the exact millimetre on customer request. Surface of the luminaire fine structure matt powder coated similar to RAL 9016 white, RAL 9006 silver or RAL 9005 black - on request in RAL of choice. Diffuser either in PMMA opal, PMMA opal U-cover or PMMA clear with inserted microprismatic plate for reduced luminance (UGR<19). The LED driver is integrated in the luminaire housing - either as on/off or DALI version. Colour temperatures 2700K, 3000K, 4000K or dynamic white (2700K-6500K) - colour rendering CRI>80 or CRI>90 - Mac Adam ≤3. Further control options or light colours available on request. In addition, the integration of many components, such as emergency lighting or sensor technology, as well as a variety of other options is possible.

Luminaire de surface LED en saillie à éclairage direct. Canal lumineux en profilé d'aluminium extrudé d'une largeur de 41 mm. Possibilité de fabriquer la longueur du luminaire au millimètre près sur demande du client. Surface du luminaire à structure fine matte revêtue de poudre similaire à RAL 9016 blanc, RAL 9006 argent ou RAL 9005 noir - sur demande en RAL au choix. Diffuseur au choix en PMMA opale, PMMA opale cache U ou PMMA transparent avec plaque microprismatique insérée pour un éblouissement réduit (UGR<19). Le pilote LED est intégré dans le boîtier du luminaire - au choix sous forme de variante on/off ou DALI. Températures de couleur 2700K, 3000K, 4000K ou blanc dynamique (2700K-6500K) - Rendu des couleurs CRI>80 ou CRI>90 - Mac Adam ≤3. Autres options de commande ou couleurs de lumière disponibles sur demande. En outre, l'intégration de nombreux composants, tels que l'éclairage de secours ou des capteurs, une multitude d'autres options sont possibles.

ÜBERSICHT | OVERVIEW | VUE D'ENSEMBLE

TECHNICAL DATA

2700K / 3000K / 4000K / 2700-6500K

CRI>80 / CRI>90

MacAdam ≤ 3

up to 124 lm/W, up to 2.849 lm/m

on-off / DALI

direct

opal / U-cover / microprism (UGR <19)

L80 B10 50.000h

HOUSING COLOUR

schwarz | black | noir
RAL 9005

silber | silver | argent
RAL 9006

weiß | white | blanc
RAL 9016



RAL colour of your choice



Integration of Multisensor



Welded mitre cuts



Integration of emergency light



Contact us for more options...

ANBAULEUCHTE „LINE40“

SURFACE MOUNTED LUMINAIRE "LINE40"
LUMINAIRE EN SAILLIE « LINE40 »

Bestellbeispiel | Example order | Exemple de commande
3.132 mm, CRI>90, 4000K, **direct**, low output on/off, black, microprism

LI40A-319401-LOBLM

1 2 3 4 5 6

1 LÄNGE LENGTH LONGEUR	
612 mm	06
972 mm	09
1.212 mm	12
1.452 mm	14
1.692 mm	16
1.932 mm	19
2.172 mm	21
2.412 mm	24
2.892 mm	28
3.132 mm	31
3.854 mm	38

2 FARBWIEDERGABE COLOUR RENDERING RENDU DES COULEURS	
CRI>80	8
CRI>90	9

3 FARBTEMPERATUR COLOUR TEMPERATURE TEMPÉRATURE DE COULEUR	
2700K (CRI>90 only)	27
3000K	30
4000K	40
2700-6500K (CRI>90 only)	DW

4 LEISTUNG & STEUERUNG OUTPUT & CONTROL SORTIE & CONTRÔLE	
low output on/off	LO
low output DALI	LD
high output on/off	HO
high output DALI	HD
dynamic white DALI DT8	DW

5 GEHÄUSEFARBE HOUSING COLOUR COULEUR DU BOÎTIER	
silver RAL 9006	SI
white RAL 9016	WH
black RAL 9005	BL

6 DIFFUSOR DIFFUSER DIFFUSEUR	
opal	O
microprism	M
U-cover	U

direct

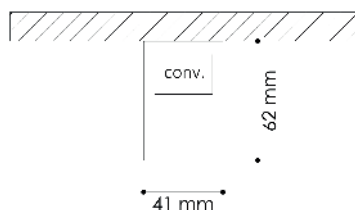

direct U-cover

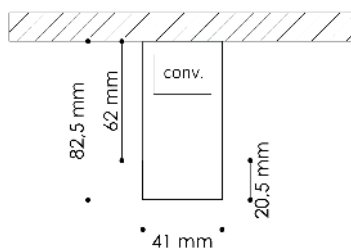

opal
direct

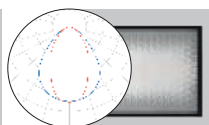

microprism
direct

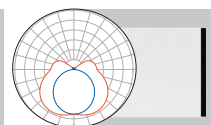

U-cover
direct

Size [mm]	opal direct		microprism direct		U-cover direct		KG
	low output [lm] / [W]	high output [lm] / [W]	low output [lm] / [W]	high output [lm] / [W]	low output [lm] / [W]	high output [lm] / [W]	
612	840 / 8,8	1.495 / 16,3	876 / 8,8	1.560 / 16,3	864 / 8,8	1.538 / 16,3	1,4
972	1.324 / 13,0	2.461 / 25,0	1.381 / 13,0	2.567 / 25,0	1.362 / 13,0	2.532 / 25,0	2,1
1.212	1.777 / 16,3	3.150 / 30,0	1.854 / 16,3	3.286 / 30,0	1.828 / 16,3	3.241 / 30,0	2,6
1.452	2.010 / 18,5	3.763 / 35,8	2.097 / 18,5	3.925 / 35,8	2.068 / 18,5	3.871 / 35,8	3,2
1.692	2.398 / 21,2	4.470 / 41,1	2.501 / 21,2	4.663 / 41,1	2.467 / 21,2	4.599 / 41,1	3,7
1.932	2.779 / 23,7	5.222 / 46,3	2.889 / 23,7	5.448 / 46,3	2.859 / 23,7	5.373 / 46,3	4,2
2.172	3.157 / 26,6	5.931 / 52,0	3.293 / 26,6	6.187 / 52,0	3.248 / 26,6	6.102 / 52,0	4,7
2.412	3.441 / 29,2	6.544 / 57,3	3.590 / 29,2	6.826 / 57,3	3.541 / 29,2	6.732 / 57,3	5,3
2.892	3.880 / 34,3	7.570 / 69,6	4.048 / 34,3	7.897 / 69,6	3.992 / 34,3	7.788 / 69,6	6,4
3.132	4.326 / 36,9	8.516 / 75,5	4.513 / 36,9	8.884 / 75,5	4.451 / 36,9	8.761 / 75,5	6,8
3.854	5.558 / 47,4	10.444 / 92,6	5.798 / 47,4	10.896 / 92,6	5.718 / 47,4	10.746 / 92,6	8,5

Alle Lumenangaben für 4000K, CRI>80, Microprisma ohne Opalfolie

All lumen values for 4000K, CRI>80, microprism without opal foil

Toutes les données de lumens pour 4000K, CRI>80, microprisme sans feuille opale

LINE50

ANBAULEUCHE | SURFACE MOUNTED LUMINAIRE | LUMINAIRE EN SAILLIE

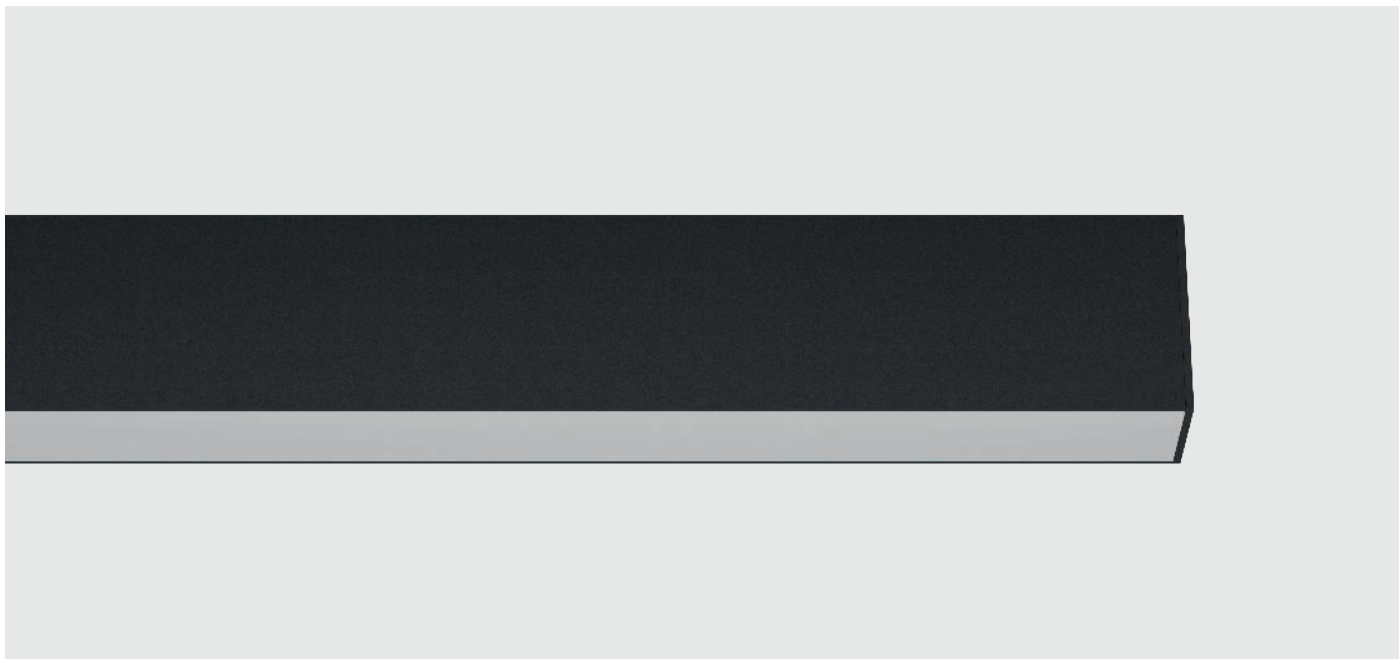

LED-Anbauleuchte direktstrahlend. Lichtkanal aus Aluminium-Strangpressprofil mit einer Breite von 50 mm. Fertigung der Leuchtenlänge millimetergenau auf Kundenwunsch möglich. Oberfläche der Leuchte feinstrukturiert matt pulverbeschichtet ähnlich RAL 9016 weiß, RAL 9006 silber oder RAL 9005 schwarz – auf Anfrage in RAL nach Wahl. Diffusor wahlweise in PMMA opal, PMMA klar mit eingeschobener asymmetrischer Folie oder PMMA klar mit eingeschobener mikroprismatischer Platte für eine reduzierte Leuchtdichte (UGR<19). Der LED-Treiber ist im Leuchtgehäuse integriert – wahlweise als on/off oder DALI-Variante. Farbtemperaturen 2700K, 3000K, 4000K oder dynamisch Weiß (2700K–6500K) – Farbwiedergabe CRI>80 oder CRI>90 – Mac Adam ≤3. Weitere Steuerungsoptionen oder Lichtfarben auf Anfrage erhältlich. Außerdem ist die Integration vieler Komponenten, wie beispielsweise Notlicht oder Sensortechnologie, sowie eine Vielzahl weiterer Optionen möglich.

Surface mounted LED luminaire with direct beam. Light channel made of extruded aluminium profile with a width of 50 mm. Luminaire length can be manufactured to the exact millimetre on customer request. Surface of the luminaire fine structure matt powder coated similar to RAL 9016 white, RAL 9006 silver or RAL 9005 black - on request in RAL of choice. Diffuser either in PMMA opal, PMMA clear with inserted asymmetrical foil or PMMA clear with inserted microprismatic plate for reduced luminance (UGR<19). The LED driver is integrated in the luminaire housing - either as on/off or DALI version. Colour temperatures 2700K, 3000K, 4000K or dynamic white (2700K-6500K) - colour rendering CRI>80 or CRI>90 - Mac Adam ≤3. Further control options or light colours available on request. In addition, the integration of many components, such as emergency lighting or sensor technology, as well as a variety of other options is possible.

Luminaire de surface LED en saillie à éclairage direct. Canal lumineux en profilé d'aluminium extrudé d'une largeur de 50 mm. Fabrication de la longueur du luminaire au millimètre près possible sur demande du client. Surface du luminaire à structure fine, revêtement par poudre mat similaire à RAL 9016 blanc, RAL 9006 argent ou RAL 9005 noir - sur demande en RAL au choix. Diffuseur au choix en PMMA opale, PMMA transparent avec feuille asymétrique insérée ou PMMA transparent avec plaque microprismatique insérée pour un éblouissement réduit (UGR<19). Le pilote LED est intégré dans le boîtier du luminaire - au choix sous forme de variante on/off ou DALI. Températures de couleur 2700K, 3000K, 4000K ou blanc dynamique (2700K-6500K) - Rendu des couleurs CRI>80 ou CRI>90 - Mac Adam ≤3. Autres options de commande ou couleurs de lumière disponibles sur demande. En outre, l'intégration de nombreux composants, tels que l'éclairage de secours ou la technologie de détection, une multitude d'autres options sont possibles.

ÜBERSICHT | OVERVIEW | VUE D'ENSEMBLE

TECHNICAL DATA

2700K / 3000K / 4000K / 2700-6500K

CRI>80 / CRI>90

MacAdam ≤ 3

up to 130 lm/W, up to 2.939 lm/m

on-off / DALI

direct

opal / microprism (UGR <19) / asymmetric

L80 B10 50.000h

HOUSING COLOUR

schwarz | black | noir
RAL 9005

silber | silver | argent
RAL 9006

weiß | white | blanc
RAL 9016



RAL colour of your choice



Integration of 3-phase-track



Integration of Multisensor



Welded mitre cuts



Integration of emergency light



Integration of GLOWmini/ GLOWsmall series



Contact us for more options...

ANBAULEUCHTE „LINE50“
 SURFACE MOUNTED LUMINAIRE “LINE50”
 LUMINAIRE EN SAILLIE « LINE50 »

Bestellbeispiel | Example order | Exemple de commande
 3.134 mm, CRI>90, 4000K, **direct**, low output on/off, black, microprism

LI50A-319401-LOBLM

1 2 3 4 5 6

1 LÄNGE LENGTH LONGEUR	
614 mm	06
974 mm	09
1.214 mm	12
1.454 mm	14
1.694 mm	16
1.934 mm	19
2.174 mm	21
2.414 mm	24
2.894 mm	28
3.134 mm	31
3.856 mm	38

2 FARBWIEDERGABE COLOUR RENDERING RENDU DES COULEURS	
CRI>80	8
CRI>90	9

3 FARBTEMPERATUR COLOUR TEMPERATURE TEMPÉRATURE DE COULEUR	
2700K (CRI>90 only)	27
3000K	30
4000K	40
2700-6500K (CRI>90 only)	DW

4 LEISTUNG & STEUERUNG OUTPUT & CONTROL SORTIE & CONTRÔLE	
low output on/off	LO
low output DALI	LD
high output on/off	HO
high output DALI	HD
dynamic white DALI DT8	DW

5 GEHÄUSEFARBE HOUSING COLOUR COULEUR DU BOÎTIER	
silver RAL 9006	SI
white RAL 9016	WH
black RAL 9005	BL

6 DIFFUSOR DIFFUSER DIFFUSEUR	
opal	O
microprism	M
asymmetric	A

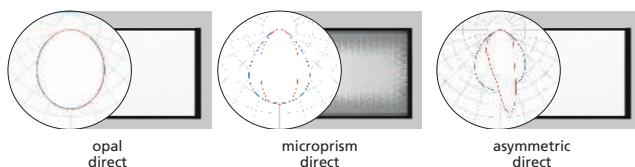
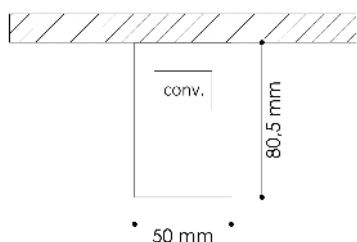

Size [mm]	opal direct		microprism direct		asymmetric direct		KG
	low output [lm] / [W]	high output [lm] / [W]	low output [lm] / [W]	high output [lm] / [W]	low output [lm] / [W]	high output [lm] / [W]	
614	909 / 8,8	1.731 / 16,3	826 / 8,8	1.581 / 16,3	925 / 8,8	1.771 / 16,3	1,5
974	1.455 / 13,0	2.770 / 25,0	1.321 / 13,0	2.530 / 25,0	1.480 / 13,0	2.834 / 25,0	2,3
1.214	1.818 / 16,3	3.463 / 30,0	1.652 / 16,3	3.162 / 30,0	1.850 / 16,3	3.541 / 30,0	2,9
1.454	2.182 / 18,5	4.156 / 35,8	1.982 / 18,5	3.794 / 35,8	2.220 / 18,5	4.249 / 35,8	3,5
1.694	2.546 / 21,2	4.848 / 41,1	2.313 / 21,2	4.427 / 41,1	2.591 / 21,2	4.958 / 41,1	4,1
1.934	2.911 / 23,7	5.541 / 46,3	2.642 / 23,7	5.059 / 46,3	2.959 / 23,7	5.666 / 46,3	4,6
2.174	3.273 / 26,6	6.233 / 52,0	2.974 / 26,6	5.692 / 52,0	3.331 / 26,6	6.375 / 52,0	5,2
2.414	3.635 / 29,2	6.926 / 57,3	3.304 / 29,2	6.324 / 57,3	3.700 / 29,2	7.083 / 57,3	5,8
2.894	4.364 / 34,3	8.311 / 69,6	3.964 / 34,3	7.589 / 69,6	4.440 / 34,3	8.500 / 69,6	7,0
3.134	4.728 / 36,9	9.004 / 75,5	4.295 / 36,9	8.221 / 75,5	4.810 / 36,9	9.208 / 75,5	7,5
3.856	5.821 / 47,4	11.082 / 92,6	5.284 / 47,4	10.118 / 92,6	5.918 / 47,4	11.332 / 92,6	9,3

Alle Lumenangaben für 4000K, CRI>80, Microprisma ohne Opalfolie
 All lumen values for 4000K, CRI>80, microprism without opal foil
 Toutes les données de lumens pour 4000K, CRI>80, microprisme sans feuille opale

LINE50hex

ANBAULEUCHTE | SURFACE MOUNTED LUMINAIRE | LUMINAIRE EN SAILLIE



LED-Anbauleuchte direktstrahlend. Lichtkanal aus Aluminium-Strangpressprofil mit einer Breite von 50 mm. Leuchte in hexagonaler Form mit verschweißten Ecken – Lieferung der drei Standardgrößen komplett in einem Stück (DM 1306 mm), in zwei Teilen (DM 2028 mm) bzw. sechs gleich großen Teilen (DM 2988 mm). Oberfläche der Leuchte feinstruktur matt pulverbeschichtet ähnlich RAL 9016 weiß, RAL 9006 silber oder RAL 9005 schwarz – auf Anfrage in RAL nach Wahl. Diffusor wahlweise in PMMA opal oder PMMA klar mit eingeschobener mikroprismatischer Platte für eine reduzierte Leuchtdichte (UGR<19). Der LED-Treiber ist im Leuchtgehäuse integriert – wahlweise als on/off oder DALI-Variante. Farbtemperaturen 2700K, 3000K, 4000K oder dynamisch Weiß (2700K–6500K) – Farbwiedergabe CRI>80 oder CRI>90 – Mac Adam ≤3. Weitere Steuerungsoptionen oder Lichtfarben auf Anfrage erhältlich. Außerdem ist die Integration vieler Komponenten, wie beispielsweise Notlicht oder Sensortechnologie, sowie eine Vielzahl weiterer Optionen möglich.

Surface mounted LED luminaire with direct beam. Light channel made of extruded aluminium profile with a width of 50 mm. Luminaire in hexagonal shape with welded corners - delivery of the three standard sizes in one piece (DM 1306 mm), in two pieces (DM 2028 mm) or in six equally sized pieces (DM 2988 mm). Surface of the luminaire fine structure matt powder coated similar to RAL 9016 white, RAL 9006 silver or RAL 9005 black - on request in RAL of choice. Diffuser either in PMMA opal or PMMA clear with inserted microprismatic plate for reduced luminance (UGR<19). The LED driver is integrated in the luminaire housing - either as on/off or DALI version. Colour temperatures 2700K, 3000K, 4000K or dynamic white (2700K-6500K) - colour rendering CRI>80 or CRI>90 - Mac Adam ≤3. Further control options or light colours available on request. In addition, the integration of many components, such as emergency lighting or sensor technology, as well as a variety of other options is possible.

Luminaire de surface LED en saillie à éclairage direct. Canal lumineux en profilé d'aluminium extrudé d'une largeur de 50 mm. Luminaire de forme hexagonale avec coins soudés - livraison des trois tailles standard complètes en une pièce (DM 1306 mm), en deux pièces (DM 2028 mm) ou en six pièces de taille identique (DM 2988 mm). Surface du luminaire à structure fine matte revêtue par poudre similaire à RAL 9016 blanc, RAL 9006 argent ou RAL 9005 noir - sur demande en RAL au choix. Diffuseur au choix en PMMA opale ou en PMMA transparent avec plaque microprismatique insérée pour un éblouissement réduit (UGR<19). Le pilote LED est intégré dans le boîtier du luminaire - au choix sous forme de variante on/off ou DALI. Températures de couleur 2700K, 3000K, 4000K ou blanc dynamique (2700K-6500K) - Rendu des couleurs CRI>80 ou CRI>90 - Mac Adam ≤3. Autres options de commande ou couleurs de lumière disponibles sur demande. En outre, l'intégration de nombreux composants, tels que l'éclairage de secours ou la technologie des capteurs, une multitude d'autres options sont possibles.

ÜBERSICHT | OVERVIEW | VUE D'ENSEMBLE

TECHNICAL DATA

2700K / 3000K / 4000K / 2700-6500K

CRI>80 / CRI>90

MacAdam ≤ 3

up to 130 lm/W, up to 2.939 lm/m

on-off / DALI

direct

opal / microprism (UGR <19)

L80 B10 50.000h

HOUSING COLOUR

schwarz | black | noir
RAL 9005

silber | silver | argent
RAL 9006

weiß | white | blanc
RAL 9016



RAL colour of your choice



Integration of 3-phase-track



Integration of Multisensor



Welded mitre cuts



Integration of emergency light



Integration of GLOWmini/
GLOWsmall series



Contact us for more options...

ANBAULEUCHTE „LINE50hex“
 SURFACE MOUNTED LUMINAIRE “LINE50hex”
 LUMINAIRE EN SAILLIE « LINE50hex »

Bestellbeispiel | Example order | Exemple de commande
 2.988 mm, CRI>90, 4000K, **direct**, low output on/off, black, microprism

LH50A-299401-LOBLM

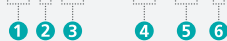

1 GRÖSSE SIZE TAILLE	
1.306 mm	13
2.028 mm	20
2.988 mm	29

2 FARBWIEDERGABE COLOUR RENDERING RENDU DES COULEURS	
CRI>80	8
CRI>90	9

3 FARBTEMPERATUR COLOUR TEMPERATURE TEMPÉRATURE DE COULEUR	
2700K (CRI>90 only)	27
3000K	30
4000K	40
2700-6500K (CRI>90 only)	DW

4 LEISTUNG & STEUERUNG OUTPUT & CONTROL SORTIE & CONTRÔLE	
low output on/off	LO
low output DALI	LD
high output on/off	HO
high output DALI	HD
dynamic white DALI DT8	DW

5 GEHÄUSEFARBE HOUSING COLOUR COULEUR DU BOÎTIER	
silver RAL 9006	SI
white RAL 9016	WH
black RAL 9005	BL

6 DIFFUSOR DIFFUSER DIFFUSEUR	
opal	O
microprism	M

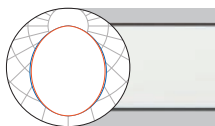
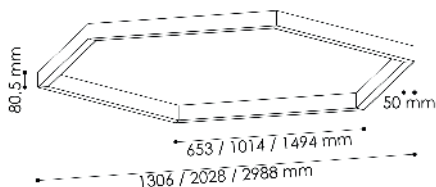

opal direct

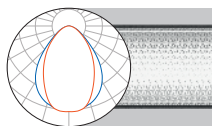

microprism direct

Size [mm]	opal direct		microprism direct		KG
	low output [lm] / [W]	high output [lm] / [W]	low output [lm] / [W]	high output [lm] / [W]	
1.306	5.454 / 44,9	10.389 / 87,7	4.956 / 44,9	9.486 / 87,7	9,0
2.028	8.730 / 67,0	16.619 / 134,8	7.926 / 67,0	15.180 / 134,8	13,8
2.988	13.092 / 99,8	24.935 / 206,0	11.892 / 99,8	22.764 / 206,0	21,0

Alle Lumenangaben für 4000K, CRI>80, Microprisma ohne Opalfolie
 All lumen values for 4000K, CRI>80, microprism without opal foil
 Toutes les données de lumens pour 4000K, CRI>80, microprisme sans feuille opale

LINE50HEXmute

ANBAULEUCHE | SURFACE MOUNTED LUMINAIRE | LUMINAIRE EN SAILLIE

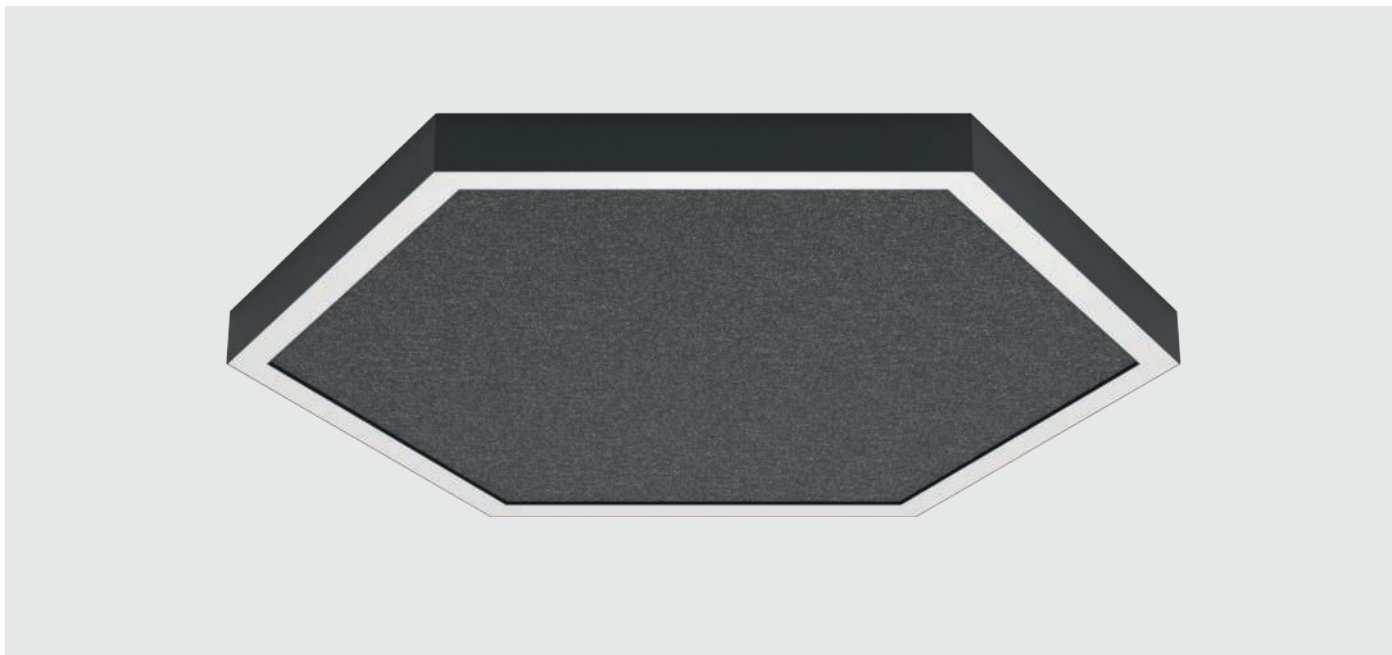

LED-Anbauleuchte direktstrahlend. Lichtkanal aus Aluminium-Strangpressprofil mit einer Breite von 50 mm. Leuchte in hexagonaler Form mit verschweißten Ecken – Lieferung komplett in einem Stück (DM 1306 mm). Oberfläche der Leuchte feinstruktur matt pulverbeschichtet ähnlich RAL 9016 weiß, RAL 9006 silber oder RAL 9005 schwarz – auf Anfrage in RAL nach Wahl. Akustikelemente aus recyceltem PET in schwarz, hellgrau meliert, anthrazit meliert, burgunderrot oder olivgrün auswählbar. Diffusor wahlweise in PMMA opal oder PMMA klar mit eingeschobener mikroprismatischer Platte für eine reduzierte Leuchtdichte (UGR<19). Der LED-Treiber ist im Leuchtgehäuse integriert – wahlweise als on/off oder DALI-Variante. Farbtemperaturen 2700K, 3000K, 4000K oder dynamisch Weiß (2700K–6500K) – Farbwiedergabe CRI>80 oder CRI>90 – Mac Adam ≤3. Weitere Steuerungsoptionen oder Lichtfarben auf Anfrage erhältlich. Außerdem ist die Integration vieler Komponenten, wie beispielsweise Notlicht oder Sensortechnologie, sowie eine Vielzahl weiterer Optionen möglich.

Surface mounted LED luminaire with direct beam. Light channel made of extruded aluminium profile with a width of 50 mm. Luminaire in hexagonal form with welded corners – delivery in one piece (DM 1306 mm). Surface of the luminaire fine structure matt powder coated similar to RAL 9016 white, RAL 9006 silver or RAL 9005 black – on request in RAL of choice. Acoustic elements available in black, light grey mottled, anthracite mottled, burgundy red or olive green. Diffuser either in PMMA opal or PMMA clear with inserted microprismatic plate for reduced luminance (UGR<19). The LED driver is integrated in the luminaire housing – either as on/off or DALI version. Colour temperatures 2700K, 3000K, 4000K or dynamic white (2700K-6500K) – colour rendering CRI>80 or CRI>90 - Mac Adam ≤3. Further control options or light colours available on request. In addition, the integration of many components, such as emergency lighting or sensor technology, as well as a variety of other options is possible.

Luminaire de surface LED en saillie à éclairage direct. Canal lumineux en profilé d'aluminium extrudé d'une largeur de 50 mm. Luminaire de forme hexagonale avec coins soudés - livraison en une pièce (DM 1306 mm). Surface du luminaire à structure fine matte revêtue par poudre similaire à RAL 9016 blanc, RAL 9006 argent ou RAL 9005 noir - sur demande en RAL au choix. Éléments acoustiques en noir, gris clair chiné, anthracite chiné, rouge bordeaux ou vert olive au choix. Diffuseur au choix en PMMA opale ou en PMMA transparent avec plaque microprismatique insérée pour un éblouissement réduit (UGR<19). Le pilote LED est intégré dans le boîtier du luminaire - au choix sous forme de variante on/off ou DALI. Températures de couleur 2700K, 3000K, 4000K ou blanc dynamique (2700K-6500K) - Rendu des couleurs CRI>80 ou CRI>90 - Mac Adam ≤3. Autres options de commande ou couleurs de lumière disponibles sur demande. En outre, l'intégration de nombreux composants, tels que l'éclairage de secours ou la technologie des capteurs, une multitude d'autres options sont possibles.

ÜBERSICHT | OVERVIEW | VUE D'ENSEMBLE

TECHNICAL DATA

2700K / 3000K / 4000K / 2700-6500K

CRI>80 / CRI>90

MacAdam ≤ 3

up to 122 lm/W, up to 2766 lm/m

on-off / DALI

direct

opal / microprism (UGR <19)

L80 B10 50.000h

acoustic material - fire classification: B-s2, d0 (EN13501-1:3018)



RAL colour of your choice



Integration of 3-phase-track



Integration of Multisensor



Welded mitre cuts



Integration of emergency light



Integration of GLOWmini/ GLOWsmall series



Contact us for more options...

HOUSING COLOUR

schwarz | black | noir
RAL 9005



silber | silver | argent
RAL 9006



weiß | white | blanc
RAL 9016



COLOUR ACOUSTIC PANEL

schwarz | black | noir



burgunderrot | burgundy red | rouge bourgogne



hellgrau meliert | light grey mottled| gris clair chiné



olivgrün | olive green | vert olive



anthrazit meliert | anthracite mottled| anthracite chiné



ANBAULEUCHTE „LINE50HEXmute“
 SURFACE MOUNTED LUMINAIRE “LINE50HEXmute”
 LUMINAIRE EN SAILLIE « LINE50HEXmute »

Bestellbeispiel | Example order | Exemple de commande
 1.306 mm, CRI90, 4000K, **direct**, low output on/off, black, olive, microprism

LH5MA-139401-LOBOM

1 2 3 4 5 6

1 FARBWIEDERGABE
 COLOUR RENDERING
 RENDU DES COULEURS

CRI>80	8
CRI>90	9

2 FARBTEMPERATUR
 COLOUR TEMPERATURE
 TEMPÉRATURE DE COULEUR

2700K (CRI>90 only)	27
3000K	30
4000K	40
2700-6500K (CRI>90 only)	DW

3 LEISTUNG & STEUERUNG
 OUTPUT & CONTROL
 SORTIE & CONTRÔLE

low output on/off	LO
low output DALI	LD
high output on/off	HO
high output DALI	HD
dynamic white DALI DT8	DW

4 GEHÄUSEFARBE
 HOUSING COLOUR
 COULEUR DU BOÎTIER

silver RAL 9006	S
white RAL 9016	W
black RAL 9005	B

5 FARBE AKUSTIKPLATTE
 COLOUR ACOUSTIC PANEL
 COULEUR PANNEAU ACOUSTIQUE

black	B
light grey mottled	S
anthracite mottled	A
burgundy red	R
olive green	O

6 DIFFUSOR
 DIFFUSER
 DIFFUSEUR

opal	O
microprism	M

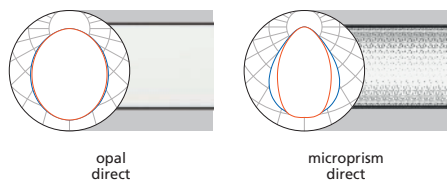
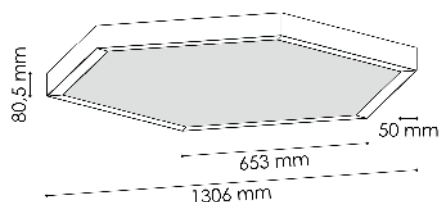

Size [mm]	low output [lm] / [W]	high output [lm] / [W]	low output [lm] / [W]	high output [lm] / [W]	
1.306	5.454 / 44,9	10.389 / 87,7	4.956 / 44,9	9.486 / 87,7	12,9

Alle Lumenangaben für 4000K, CRI>80, Microprisma ohne Opalfolie
 All lumen values for 4000K, CRI>80, microprism without opal foil
 Toutes les données de lumens pour 4000K, CRI>80, microprisme sans feuille opale

LINE50quad

ANBAULEUCHTE | SURFACE MOUNTED LUMINAIRE | LUMINAIRE EN SAILLIE



LED-Anbauleuchte direktstrahlend. Lichtkanal aus Aluminium-Strangpressprofil mit einer Breite von 50 mm. Leuchte in quadratischer Form mit verschweißten Ecken – Lieferung der drei Standardgrößen komplett in einem Stück (660, 1020 mm) bzw. in zwei Teilen (1500 mm). Oberfläche der Leuchte feinstruktur matt pulverbeschichtet ähnlich RAL 9016 weiß, RAL 9006 silber oder RAL 9005 schwarz – auf Anfrage in RAL nach Wahl. Diffusor wahlweise in PMMA opal oder PMMA klar mit eingeschobener mikroprismatischer Platte für eine reduzierte Leuchtdichte (UGR<19). Der LED-Treiber ist im Leuchtengehäuse integriert – wahlweise als on/off oder DALI-Variante. Farbtemperaturen 2700K, 3000K, 4000K oder dynamisch Weiß (2700K–6500K) – Farbwiedergabe CRI>80 oder CRI>90 – Mac Adam ≤3. Weitere Steuerungsoptionen oder Lichtfarben auf Anfrage erhältlich. Außerdem ist die Integration vieler Komponenten, wie beispielsweise Notlicht oder Sensortechnologie, sowie eine Vielzahl weiterer Optionen möglich.

Surface mounted LED luminaire with direct beam. Light channel made of extruded aluminium profile with a width of 50 mm. Luminaire in square shape with welded corners - delivery of the three standard sizes in one piece (660, 1020 mm) or in two pieces (1500 mm). Surface of the luminaire fine structure matt powder coated similar to RAL 9016 white, RAL 9006 silver or RAL 9005 black - on request in RAL of choice. Diffuser either in PMMA opal or PMMA clear with inserted microprismatic plate for reduced luminance (UGR<19). The LED driver is integrated in the luminaire housing - either as on/off or DALI version. Colour temperatures 2700K, 3000K, 4000K or dynamic white (2700K-6500K) - colour rendering CRI>80 or CRI>90 - Mac Adam ≤3. Further control options or light colours available on request. In addition, the integration of many components, such as emergency lighting or sensor technology, as well as a variety of other options is possible.

Luminaire de surface LED en saillie à éclairage direct. Canal lumineux en profilé d'aluminium extrudé d'une largeur de 50 mm. Luminaire de forme carrée avec coins soudés - livraison des trois tailles standard complètes en une pièce (660, 1020 mm) ou en deux pièces (1500 mm). Surface du luminaire à structure fine matte revêtue par poudre similaire à RAL 9016 blanc, RAL 9006 argent ou RAL 9005 noir - sur demande en RAL au choix. Diffuseur au choix en PMMA opale ou en PMMA transparent avec plaque microprismatique insérée pour un éblouissement réduit (UGR<19). Le pilote LED est intégré dans le boîtier du luminaire - au choix sous forme de variante on/off ou DALI. Températures de couleur 2700K, 3000K, 4000K ou blanc dynamique (2700K-6500K) - Rendu des couleurs CRI>80 ou CRI>90 - Mac Adam ≤3. Autres options de commande ou couleurs de lumière disponibles sur demande. En outre, l'intégration de nombreux composants, tels que l'éclairage de secours ou la technologie des capteurs, une multitude d'autres options sont possibles.

ÜBERSICHT | OVERVIEW | VUE D'ENSEMBLE

TECHNICAL DATA

2700K / 3000K / 4000K / 2700-6500K

CRI>80 / CRI>90

MacAdam ≤ 3

up to 130 lm/W, up to 2.939 lm/m

on-off / DALI

direct

opal / microprism (UGR <19)

L80 B10 50.000h

HOUSING COLOUR

schwarz | black | noir
RAL 9005

silber | silver | argent
RAL 9006

weiß | white | blanc
RAL 9016



RAL colour of your choice



Integration of 3-phase-track



Integration of Multisensor



Welded mitre cuts



Integration of emergency light



Integration of GLOWmini/ GLOWsmall series



Contact us for more options...

ANBAULEUCHTE „LINE50quad“
 SURFACE MOUNTED LUMINAIRE “LINE50quad”
 LUMINAIRE EN SAILLIE « LINE50quad »

Bestellbeispiel | Example order | Exemple de commande
 660 x 660 mm, CRI>90, 4000K, **direct**, low output on/off, black, microprism

LQ50A-069401-LOBLM

1 2 3 4 5 6

1 GRÖSSE SIZE TAILLE	
660 x 660 mm	06
1.020 x 1.020 mm	10
1.500 x 1.500 mm	15

2 FARBWIEDERGABE COLOUR RENDERING RENDU DES COULEURS	
CRI>80	8
CRI>90	9

3 FARBTEMPERATUR COLOUR TEMPERATURE TEMPÉRATURE DE COULEUR	
2700K (CRI>90 only)	27
3000K	30
4000K	40
2700-6500K (CRI>90 only)	DW

4 LEISTUNG & STEUERUNG OUTPUT & CONTROL SORTIE & CONTRÔLE	
low output on/off	LO
low output DALI	LD
high output on/off	HO
high output DALI	HD
dynamic white DALI DT8	DW

5 GEHÄUSEFARBE HOUSING COLOUR COULEUR DU BOÎTIER	
silver RAL 9006	SI
white RAL 9016	WH
black RAL 9005	BL

6 DIFFUSOR DIFFUSER DIFFUSEUR	
opal	O
microprism	M

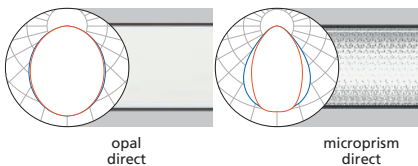
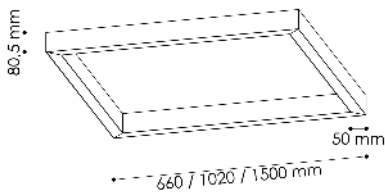

Size [mm]	opal direct		microprism direct		KE
	low output [lm] / [W]	high output [lm] / [W]	low output [lm] / [W]	high output [lm] / [W]	
□ 660	3.637 / 29,1	6.926 / 57,2	3.304 / 29,1	6.324 / 57,2	6,0
□ 1.020	5.821 / 44,6	11.080 / 91,7	5.284 / 44,6	10.120 / 91,7	9,2
□ 1.500	8.728 / 67,0	16.624 / 134,8	7.928 / 67,0	15.176 / 134,8	14,0

Alle Lumenangaben für 4000K, CRI>80, Microprisma ohne Opalfolie
 All lumen values for 4000K, CRI>80, microprism without opal foil
 Toutes les données de lumens pour 4000K, CRI>80, microprisme sans feuille opale

LINE50QUADmute

ANBAULEUCHTE | SURFACE MOUNTED LUMINAIRE | LUMINAIRE EN SAILLIE

























LED-Anbauleuchte direktstrahlend. Lichtkanal aus Aluminium-Strangpressprofil mit einer Breite von 50 mm. Leuchte in quadratischer Form mit verschweißten Ecken – Lieferung der zwei Standardgrößen komplett in einem Stück (660, 1020 mm). Oberfläche der Leuchte feinstruktur matt pulverbeschichtet ähnlich RAL 9016 weiß, RAL 9006 silber oder RAL 9005 schwarz – auf Anfrage in RAL nach Wahl. Akustikelemente aus recyceltem PET in schwarz, hellgrau meliert, anthrazit meliert, burgunderrot oder olivgrün auswählbar. Diffusor wahlweise in PMMA opal oder PMMA klar mit eingeschobener mikroprismatischer Platte für eine reduzierte Leuchtdichte (UGR<19). Der LED-Treiber ist im Leuchtgehäuse integriert – wahlweise als on/off oder DALI-Variante – Farbtemperaturen 2700K, 3000K, 4000K oder dynamisch Weiß (2700K– 6500K) – Farbwiedergabe CRI>80 oder CRI>90 – Mac Adam ≤3. Weitere Steuerungsoptionen oder Lichtfarben auf Anfrage erhältlich. Außerdem ist die Integration vieler Komponenten, wie beispielsweise Notlicht oder Sensortechnologie, sowie eine Vielzahl weiterer Optionen möglich.

Surface mounted LED luminaire with direct beam. Light channel made of extruded aluminium profile with a width of 50 mm. Luminaire in square shape with welded corners – delivery of the two standard sizes in one piece (660, 1020 mm). Surface of the luminaire fine structure matt powder coated similar to RAL 9016 white, RAL 9006 silver or RAL 9005 black – on request in RAL of choice. Acoustic elements made of recycled PET available in black, light grey mottled, anthracite mottled, burgundy red or olive green. Diffuser either in PMMA opal or PMMA clear with inserted microprismatic plate for reduced luminance (UGR<19). The LED driver is integrated in the luminaire housing – either as on/off or DALI version – colour temperatures 2700K, 3000K, 4000K or dynamic white (2700K-6500K) – colour rendering CRI>80 or CRI>90 – Mac Adam ≤3. Further control options or light colours available on request. In addition, the integration of many components, such as emergency lighting or sensor technology, as well as a variety of other options is possible.

Luminaire de surface LED en saillie à éclairage direct. Canal lumineux en profilé d'aluminium extrudé d'une largeur de 50 mm. Luminaire de forme carrée avec coins soudés – livraison des deux tailles standard complètes en une pièce (660, 1020 mm). Surface du luminaire à structure entièrement en une seule pièce. Surface du luminaire à structure fine matte revêtue par poudre similaire à RAL 9016 blanc, RAL 9006 argent ou RAL 9005 noir – sur demande en RAL au choix. Éléments acoustiques fabriqués en PET recyclé en noir, gris clair chiné, anthracite chiné, rouge bordeaux ou vert olive au choix. Diffuseur au choix en PMMA opale ou en PMMA transparent avec plaque microprismatique insérée pour un éblouissement réduit (UGR<19). Le pilote LED est intégré dans le boîtier du luminaire – au choix sous forme de variante on/off ou DALI – températures de couleur 2700K, 3000K, 4000K ou blanc dynamique (2700K-6500K) – rendu des couleurs CRI>80 ou CRI>90 – Mac Adam ≤3. Autres options de commande ou couleurs de lumière disponibles sur demande. En outre, l'intégration de nombreux composants, tels que l'éclairage de secours ou la technologie des capteurs, une multitude d'autres options sont possibles.

ÜBERSICHT | OVERVIEW | VUE D'ENSEMBLE

TECHNICAL DATA	
2700K / 3000K / 4000K / 2700-6500K	
CRI>80 / CRI>90	
MacAdam ≤ 3	
up to 131 lm/W, up to 2766 lm/m	
on-off / DALI	
direct	
opal / microprism (UGR <19)	
L80 B10 50.000h	
acoustic material - fire classification: B-s2, d0 (EN13501-1:3018)	
HOUSING COLOUR	
schwarz black noir RAL 9005	
silber silver argent RAL 9006	
weiß white blanc RAL 9016	

							
							
RAL colour of your choice	Integration of 3-phase-track	Integration of Multisensor	Welded mitre cuts	Integration of emergency light	Integration of GLOWmini/ GLOWsmall series	Contact us for more options...	
COLOUR ACOUSTIC PANEL							
schwarz black noir		burgunderrot burgundy red rouge bourgogne					
hellgrau meliert light grey mottled gris clair chiné		olivgrün olive green vert olive					
anthrazit meliert anthracite mottled anthracite chiné							

ANBAULEUCHTE „LINE50QUADmute“
 SURFACE MOUNTED LUMINAIRE “LINE50QUADmute”
 LUMINAIRE EN SAILLIE « LINE50QUADmute »

Bestellbeispiel | Example order | Exemple de commande
 660 x 660 mm, CRI90, 4000K, **direct**, low output on/off, black, olive, microprism

LQ5MA-069401-LOBOM

1 2 3 4 5 6 7

1 GRÖSSE
 SIZE
 TAILLE

660 x 660 mm	06
1.020 x 1.020 mm	10

2 FARBWIEDERGABE
 COLOUR RENDERING
 RENDU DES COULEURS

CRI>80	8
CRI>90	9

3 FARBTEMPERATUR
 COLOUR TEMPERATURE
 TEMPÉRATURE DE COULEUR

2700K (CRI>90 only)	27
3000K	30
4000K	40
2700-6500K (CRI>90 only)	DW

4 LEISTUNG & STEUERUNG
 OUTPUT & CONTROL
 SORTIE & CONTRÔLE

low output on/off	LO
low output DALI	LD
high output on/off	HO
high output DALI	HD
dynamic white DALI DT8	DW

5 GEHÄUSEFARBE
 HOUSING COLOUR
 COULEUR DU BOÎTIER

silver RAL 9006	S
white RAL 9016	W
black RAL 9005	B

6 FARBE AKUSTIKPLATTE
 COLOUR ACOUSTIC PANEL
 COULEUR PANNEAU ACOUSTIQUE

black	B
light grey mottled	S
anthracite mottled	A
burgundy red	R
olive green	O

7 DIFFUSOR
 DIFFUSER
 DIFFUSEUR

opal	O
microprism	M

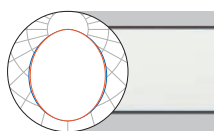
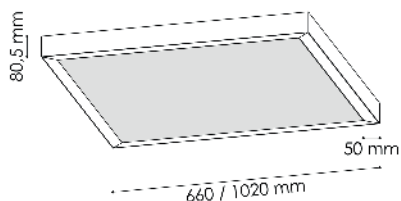

opal
direct

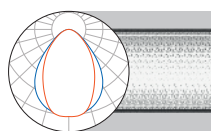

microprism
direct

Size [mm]	low output [lm] / [W]	high output [lm] / [W]	low output [lm] / [W]	high output [lm] / [W]	
□ 660	3.637 / 29,1	6.926 / 57,2	3.304 / 29,1	6.324 / 57,2	7,3
□ 1.020	5.821 / 44,6	11.080 / 91,7	5.284 / 44,6	10.120 / 91,7	12,7

Alle Lumenangaben für 4000K, CRI>80, Microprisma ohne Opalfolie
 All lumen values for 4000K, CRI>80, microprism without opal foil
 Toutes les données de lumens pour 4000K, CRI>80, microprisme sans feuille opale

LINE50splash

ANBAULEUCHE | SURFACE MOUNTED LUMINAIRE | LUMINAIRE EN SAILLIE



LED-Anbauleuchte mit erhöhter Schutzart IP54 direktstrahlend. Lichtkanal aus Aluminium-Strangpressprofil mit einer Breite von 50 mm. Oberfläche der Leuchte feinstruktur matt pulverbeschichtet ähnlich RAL 9016 weiß, RAL 9006 silber oder RAL 9005 schwarz – auf Anfrage in RAL nach Wahl. Diffusor wahlweise in PMMA opal, PMMA klar mit eingeschobener asymmetrischer Folie oder PMMA klar mit eingeschobener mikroprismatischer Platte für eine reduzierte Leuchtdichte (UGR<19). Der LED-Treiber ist im Leuchtgehäuse integriert – wahlweise als on/off oder DALI-Variante – Farbtemperaturen 2700K, 3000K, 4000K oder dynamisch Weiß (2700K–6500K) – Farbwiedergabe CRI>80 oder CRI>90 – Mac Adam ≤3. Weitere Steuerungsoptionen oder Lichtfarben auf Anfrage erhältlich. Außerdem ist die Integration vieler Komponenten, wie beispielsweise Notlicht, sowie eine Vielzahl weiterer Optionen möglich.

Surface mounted LED luminaire with increased protection rating IP54 and direct beam. Light channel made of extruded aluminium profile with a width of 50 mm. Surface of the luminaire fine structure matt powder coated similar to RAL 9016 white, RAL 9006 silver or RAL 9005 black - on request in RAL of choice. Diffuser either in PMMA opal, PMMA clear with inserted asymmetric foil or PMMA clear with inserted microprismatic plate for reduced luminance (UGR<19). The LED driver is integrated in the luminaire housing - either as on/off or DALI version - colour temperatures 2700K, 3000K, 4000K or dynamic white (2700K-6500K) - colour rendering CRI>80 or CRI>90 - Mac Adam ≤3. Further control options or light colours available on request. In addition, the integration of many components, such as emergency lighting, as well as a variety of other options is possible.

Luminaire de surface LED en saillie avec un degré de protection élevé IP54 à éclairage direct. Canal lumineux en profilé d'aluminium extrudé d'une largeur de 50 mm. Surface du luminaire à structure fine, revêtement par poudre mat similaire à RAL 9016 blanc, RAL 9006 argent ou RAL 9005 noir - sur demande en RAL au choix. Diffuseur au choix en PMMA opale, PMMA transparent avec feuille asymétrique insérée ou PMMA transparent avec plaque microprismatique insérée pour un éblouissement réduit (UGR<19). Le pilote LED est intégré dans le boîtier du luminaire - au choix sous forme de variante on/off ou DALI - températures de couleur 2700K, 3000K, 4000K ou blanc dynamique (2700K-6500K) - rendu des couleurs CRI>80 ou CRI>90 - Mac Adam ≤3. Autres options de commande ou couleurs de lumière disponibles sur demande. En outre, l'intégration de nombreux composants, tels que l'éclairage de secours, une multitude d'autres options sont possibles.

ÜBERSICHT | OVERVIEW | VUE D'ENSEMBLE

TECHNICAL DATA

2700K / 3000K / 4000K / 2700-6500K

CRI>80 / CRI>90

MacAdam ≤ 3

up to 130 lm/W, up to 2.930 lm/m

on-off / DALI

direct

opal / microprism (UGR <19) / asymmetric

L80 B10 50.000h

HOUSING COLOUR

schwarz | black | noir
RAL 9005

silber | silver | argent
RAL 9006

weiß | white | blanc
RAL 9016



RAL colour of your choice



Integration of emergency light



Contact us for more options...

ANBAULEUCHTE „LINE50splash“
 SURFACE MOUNTED LUMINAIRE “LINE50splash”
 LUMINAIRE EN SAILLIE « LINE50splash »

Bestellbeispiel | Example order | Exemple de commande
 3.145 mm, CRI90, 4000K, **direct**, low output on/off, black, microprism

LS50A-319401-LOBLM

1 2 3 4 5 6

1 LÄNGE LENGTH LONGEUR	
625 mm	06
985 mm	09
1.225 mm	12
1.465 mm	14
1.705 mm	17
1.945 mm	19
2.185 mm	21
2.425 mm	24
2.905 mm	29
3.145 mm	31
3.867 mm	38

2 FARBWIEDERGABE COLOUR RENDERING RENDU DES COULEURS	
CRI>80	8
CRI>90	9

3 FARBTEMPERATUR COLOUR TEMPERATURE TEMPÉRATURE DE COULEUR	
2700K (CRI>90 only)	27
3000K	30
4000K	40
2700-6500K (CRI>90 only)	DW

4 LEISTUNG & STEUERUNG OUTPUT & CONTROL SORTIE & CONTRÔLE	
low output on/off	LO
low output DALI	LD
high output on/off	HO
high output DALI	HD
dynamic white DALI DT8	DW

5 GEHÄUSEFARBE HOUSING COLOUR COULEUR DU BOÎTIER	
silver RAL 9006	SI
white RAL 9016	WH
black RAL 9005	BL

6 DIFFUSOR DIFFUSER DIFFUSEUR	
opal	O
microprism	M
asymmetric	A

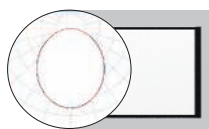
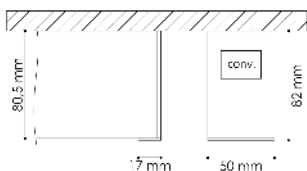

opal
direct

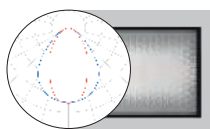

microprism
direct

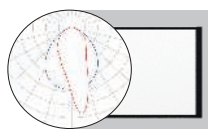

asymmetric
direct

Size [mm]	low output [lm] / [W]	high output [lm] / [W]	low output [lm] / [W]	high output [lm] / [W]	low output [lm] / [W]	high output [lm] / [W]	kg
625	908 / 8,8	1.731 / 16,3	826 / 8,8	1.731 / 16,3	867 / 8,8	1.660 / 16,3	1,9
985	1.455 / 13,0	2.770 / 25,0	1.321 / 13,0	2.770 / 25,0	1.387 / 13,0	2.656 / 25,0	2,7
1.225	1.818 / 16,3	3.463 / 30,0	1.652 / 16,3	3.162 / 30,0	1.735 / 16,3	3.320 / 30,0	3,3
1.465	2.182 / 18,5	4.156 / 35,8	1.982 / 18,5	3.794 / 35,8	2.081 / 18,5	3.984 / 35,8	3,9
1.705	2.546 / 21,2	4.848 / 41,1	2.313 / 21,2	4.427 / 41,1	2.429 / 21,2	4.648 / 41,1	4,5
1.945	2.911 / 23,7	5.541 / 46,3	2.642 / 23,7	5.059 / 46,3	2.774 / 23,7	5.312 / 46,3	5,0
2.185	3.273 / 26,6	6.233 / 52,0	2.974 / 26,6	5.692 / 52,0	3.123 / 26,6	5.977 / 52,0	5,6
2.425	3.635 / 29,2	6.926 / 57,3	3.304 / 29,2	6.324 / 57,3	3.469 / 29,2	6.640 / 57,3	6,2
2.905	4.364 / 34,3	8.311 / 69,6	3.964 / 34,3	7.589 / 69,6	4.162 / 34,3	7.968 / 69,6	7,4
3.145	4.728 / 36,9	9.004 / 75,5	4.295 / 36,9	8.221 / 75,5	4.510 / 36,9	8.632 / 75,5	7,9
3.867	5.821 / 47,4	11.082 / 92,6	5.284 / 47,4	10.118 / 92,6	5.548 / 47,4	10.624 / 92,6	9,7

Alle Lumenangaben für 4000K, CRI>80, Microprisma ohne Opalfolie
 All lumen values for 4000K, CRI>80, microprism without opal foil
 Toutes les données de lumens pour 4000K, CRI>80, microprisme sans feuille opale

officeLINE50

ANBAULEUCHTE | SURFACE MOUNTED LUMINAIRE | LUMINAIRE EN SAILLIE



LED-Anbauleuchte direktstrahlend. Lichtkanal aus Aluminium-Strangpressprofil mit einer Breite von 50 mm. Fertigung der Leuchtenlänge millimetergenau auf Kundenwunsch möglich. Oberfläche der Leuchte feinstruktur matt pulverbeschichtet ähnlich RAL 9016 weiß, RAL 9006 silber oder RAL 9005 schwarz – auf Anfrage in RAL nach Wahl. Die Leuchte ist ausgestattet mit einem hochwertigen, facettierten BAP-Raster mit einer Auswahl an sieben verschiedenen Farben – Oberfläche hochglänzend bzw. matt. Der LED-Treiber ist im Leuchtengehäuse integriert – wahlweise als on/off oder DALI-Variante. Farbtemperaturen 2700K, 3000K, 4000K oder dynamisch Weiß (2700K–6500K) – Farbwiedergabe CRI>80 oder CRI>90 – MacAdam ≤3. Weitere Steuerungsoptionen oder Lichtfarben auf Anfrage erhältlich. Außerdem ist die Integration vieler Komponenten, wie beispielsweise Notlicht oder Sensortechnologie, sowie eine Vielzahl weiterer Optionen möglich.

Surface mounted LED luminaire with direct beam. Light channel made of extruded aluminium profile with a width of 50 mm. Luminaire length can be manufactured to the exact millimetre on customer request. Surface of the luminaire fine structure matt powder coated similar to RAL 9016 white, RAL 9006 silver or RAL 9005 black - on request in RAL of choice. The luminaire is equipped with a high-quality, faceted BAP louvre with a choice of seven different colours - specular or matt finish. The LED driver is integrated in the luminaire housing - either as on/off or DALI version. Colour temperatures 2700K, 3000K, 4000K or dynamic white (2700K-6500K) - colour rendering CRI>80 or CRI>90 - MacAdam ≤3. Further control options or light colours available on request. In addition, the integration of many components, such as emergency lighting or sensor technology, as well as a variety of other options is possible.

Luminaire de surface LED en saillie à éclairage direct. Canal lumineux en profilé d'aluminium extrudé d'une largeur de 50 mm. Possibilité de fabriquer la longueur du luminaire au millimètre près sur demande du client. Surface du luminaire à structure fine, revêtement par poudre mat similaire à RAL 9016 blanc, RAL 9006 argent ou RAL 9005 noir - sur demande en RAL au choix. Le luminaire est équipé d'une grille BAP à facettes de haute qualité avec un choix de sept couleurs différentes - surface brillante ou mate. Le pilote LED est intégré dans le boîtier du luminaire - au choix sous forme de variante on/off ou DALI. Températures de couleur 2700K, 3000K, 4000K ou blanc dynamique (2700K-6500K) - Rendu des couleurs CRI>80 ou CRI>90 - MacAdam ≤3. Autres options de commande ou couleurs de lumière disponibles sur demande. En outre, l'intégration de nombreux composants, tels que l'éclairage de secours ou la technologie de détection, une multitude d'autres options sont possibles.

ÜBERSICHT | OVERVIEW | VUE D'ENSEMBLE

TECHNICAL DATA

2700K / 3000K / 4000K / 2700-6500K

CRI>80 / CRI>90

MacAdam ≤ 3

up to 152 lm/W, up to 4.323 lm/m

on-off / DALI

direct

BAP-Louvre (UGR <19)

L80 B10 50.000h



RAL colour of your choice



Integration of 3-phase-track



Integration of Multisensor



Welded mitre cuts



Integration of emergency light



Integration of GLOWmini/ GLOWsmall series



Contact us for more options...

HOUSING COLOUR

schwarz | black | noir
RAL 9005



silber | silver | argent
RAL 9006



weiß | white | blanc
RAL 9016



BAP LOUVRE COLOUR

silber hochglanz | silver specular | argenté brillant



gold hochglanz | gold specular | doré brillant



silber matt | silver matt | argenté mat



bronze hochglanz | bronze specular | bronze brillant



schwarz hochglanz | black specular | noir brillant



titan hochglanz | titan specular | titan brillant



schwarz matt | black matt | noir mat



ANBAULEUCHTE „officeLINE50“
 SURFACE MOUNTED LUMINAIRE “officeLINE50”
 LUMINAIRE EN SAILLIE « officeLINE50 »

Bestellbeispiel | Example order | Exemple de commande
 3.372 mm, CRI>90, 4000K, **direct**, low output on/off, black, gold specular

OL50A-339401-LOBLG

1 2 3 4 5 6

1 LÄNGE LENGTH LONGEUR	
491 mm	04
971 mm	09
1.211 mm	12
1.451 mm	14
1.691 mm	16
2.171 mm	21
2.891 mm	28
3.372 mm	33

2 FARBWIEDERGABE COLOUR RENDERING RENDU DES COULEURS	
CRI>80	8
CRI>90	9

3 FARBTEMPERATUR COLOUR TEMPERATURE TEMPÉRATURE DE COULEUR	
2700K (CRI>90 only)	27
3000K	30
4000K	40
2700-6500K (CRI>90 only)	DW

4 LEISTUNG & STEUERUNG OUTPUT & CONTROL SORTIE & CONTRÔLE	
low output on/off	LO
low output DALI	LD
high output on/off	HO
high output DALI	HD
dynamic white DALI DT8	DW

5 GEHÄUSEFARBE HOUSING COLOUR COULEUR DU BOÎTIER	
silver RAL 9006	SI
white RAL 9016	WH
black RAL 9005	BL

6 BAP-RASTER FARBE BAP LOUVRE COLOUR GRILLE BAP COULEUR	
silver specular	S
silver matt	M
black specular	N
black matt	B
gold specular	G
bronze specular	C
titan specular	T

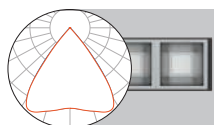
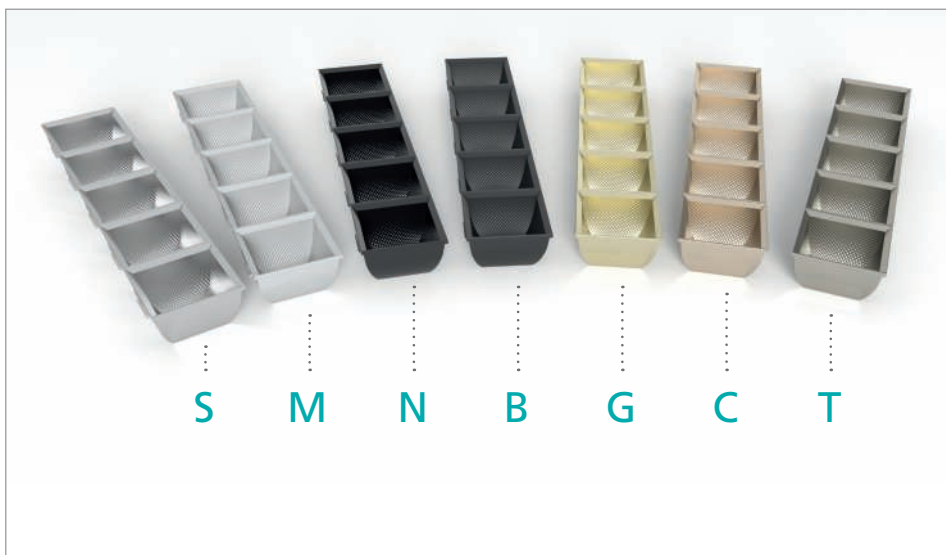
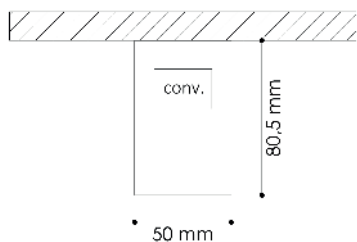

direct

Size [mm]	low output [lm] / [W]	high output [lm] / [W]	KG
491	1.106 / 8,6	2.064 / 16,5	1,4
971	2.212 / 16,7	4.128 / 31,9	2,3
1.211	2.765 / 20,0	5.160 / 39,0	2,8
1.451	3.318 / 23,5	6.192 / 46,0	3,3
1.691	3.871 / 27,0	7.224 / 53,2	3,7
2.171	4.977 / 33,9	9.288 / 67,0	4,7
2.891	6.636 / 43,8	12.384 / 87,9	6,3
3.372	7.742 / 54,0	14.448 / 106,4	7,4

Alle Lumenangaben für 4000K, CRI>80, Reflektor silber hochglanz
 All lumen values for 4000K, CRI>80, reflector silver specular
 Toutes les données de lumens pour 4000K, CRI>80, réflecteur argenté brillant

LINE70

ANBAULEUCHTE | SURFACE MOUNTED LUMINAIRE | LUMINAIRE EN SAILLIE

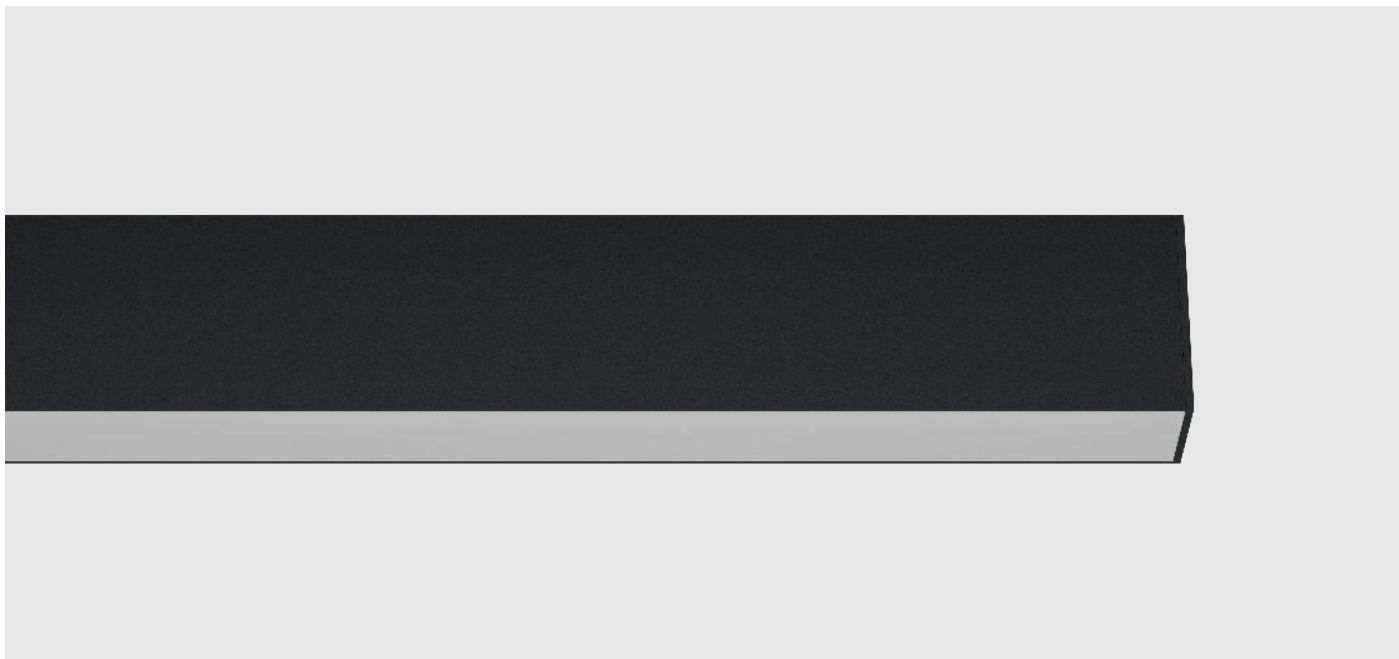

LED-Anbauleuchte direktstrahlend. Lichtkanal aus Aluminium-Strangpressprofil mit einer Breite von 71mm. Fertigung der Leuchtenlänge millimetergenau auf Kundenwunsch möglich. Oberfläche der Leuchte feinstruktur matt pulverbeschichtet ähnlich RAL 9016 weiß, RAL 9006 silber oder RAL 9005 schwarz – auf Anfrage in RAL nach Wahl. Diffusor wahlweise in PMMA opal oder PMMA klar mit eingeschobener mikroprismatischer Platte für eine reduzierte Leuchtdichte (UGR<19). Der LED-Treiber ist im Leuchtgehäuse integriert – wahlweise als on/off oder DALI-Variante. Farbtemperaturen 2700K, 3000K, 4000K oder dynamisch Weiß (2700K–6500K) – Farbwiedergabe CRI>80 oder CRI>90 – Mac Adam ≤3. Weitere Steuerungsoptionen oder Lichtfarben auf Anfrage erhältlich. Außerdem ist die Integration vieler Komponenten, wie beispielsweise Notlicht oder Sensortechnologie, sowie eine Vielzahl weiterer Optionen möglich.

Surface mounted LED luminaire with direct beam. Light channel made of extruded aluminium profile with a width of 71 mm. Luminaire length can be manufactured to the exact millimetre on customer request. Surface of the luminaire fine structure matt powder coated similar to RAL 9016 white, RAL 9006 silver or RAL 9005 black - on request in RAL of choice. Diffuser either in PMMA opal or PMMA clear with inserted microprismatic plate for reduced luminance (UGR<19). The LED driver is integrated in the luminaire housing - either as on/off or DALI version. Colour temperatures 2700K, 3000K, 4000K or dynamic white (2700K-6500K) - colour rendering CRI>80 or CRI>90 - Mac Adam ≤3. Further control options or light colours available on request. In addition, the integration of many components, such as emergency lighting or sensor technology, as well as a variety of other options is possible.

Luminaire de surface LED en saillie à éclairage direct. Canal lumineux en profilé d'aluminium extrudé d'une largeur de 71mm. Fabrication de la longueur du luminaire au millimètre près possible sur demande du client. Surface du luminaire à structure fine, revêtement par poudre mat similaire à RAL 9016 blanc, RAL 9006 argent ou RAL 9005 noir - sur demande en RAL au choix. Diffuseur au choix en PMMA opale ou en PMMA transparent avec plaque microprismatique insérée pour un éblouissement réduit (UGR<19). Le pilote LED est intégré dans le boîtier du luminaire - au choix sous forme de variante on/off ou DALI. Températures de couleur 2700K, 3000K, 4000K ou blanc dynamique (2700K-6500K) - Rendu des couleurs CRI>80 ou CRI>90 - Mac Adam ≤3. Autres options de commande ou couleurs de lumière disponibles sur demande. En outre, l'intégration de nombreux composants, tels que l'éclairage de secours ou la technologie de détection, une multitude d'autres options sont possibles.

ÜBERSICHT | OVERVIEW | VUE D'ENSEMBLE

TECHNICAL DATA

2700K / 3000K / 4000K / 2700-6500K

CRI>80 / CRI>90

MacAdam ≤ 3

up to 125 lm/W, up to 2836 lm/m

on-off / DALI

direct

opal / microprism (UGR <19)

L80 B10 50.000h

HOUSING COLOUR

schwarz | black | noir
RAL 9005

silber | silver | argent
RAL 9006

weiß | white | blanc
RAL 9016



RAL colour of your choice



Integration of Multisensor



Welded mitre cuts



Integration of emergency light



Contact us for more options...

ANBAULEUCHTE „LINE70“

SURFACE MOUNTED LUMINAIRE “LINE70”

LUMINAIRE EN SAILLIE « LINE70 »

Bestellbeispiel | Example order | Exemple de commande

3.134 mm, CRI>90, 4000K, **direct**, low output on/off, black, microprism

LI70A-319401-LOBLM

1 2 3 4 5 6

1 LÄNGE LENGTH LONGEUR

614 mm	06
974 mm	09
1.214 mm	12
1.454 mm	14
1.694 mm	16
1.934 mm	19
2.174 mm	21
2.414 mm	24
2.894 mm	28
3.134 mm	31
3.856 mm	38

2 FARBWIEDERGABE COLOUR RENDERING RENDU DES COULEURS

CRI>80	8
CRI>90	9

3 FARBTEMPERATUR COLOUR TEMPERATURE TEMPÉRATURE DE COULEUR

2700K (CRI>90 only)	27
3000K	30
4000K	40
2700-6500K (CRI>90 only)	DW

4 LEISTUNG & STEUERUNG OUTPUT & CONTROL SORTIE & CONTRÔLE

low output on/off	LO
low output DALI	LD
high output on/off	HO
high output DALI	HD
dynamic white DALI DT8	DW

5 GEHÄUSEFARBE HOUSING COLOUR COULEUR DU BOÎTIER

silver RAL 9006	SI
white RAL 9016	WH
black RAL 9005	BL

6 DIFFUSOR DIFFUSER DIFFUSEUR

opal	O
microprism	M

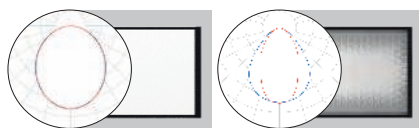
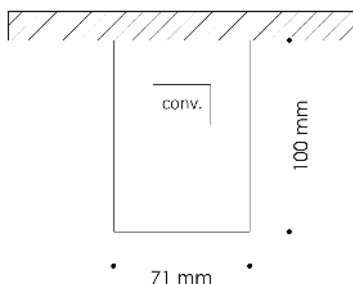

opal
direct

microprism
direct

Size [mm]	opal direct		microprism direct		kg
	low output [lm] / [W]	high output [lm] / [W]	low output [lm] / [W]	high output [lm] / [W]	
614	1.077 / 11,8	1.709 / 16,3	1.045 / 11,8	1.608 / 16,3	2,2
974	1.723 / 15,2	2.734 / 25,0	1.672 / 15,2	2.573 / 25,0	3,1
1.214	2.154 / 18,8	3.418 / 30,0	2.090 / 18,8	3.216 / 30,0	3,6
1.454	2.585 / 22,1	4.102 / 35,8	2.508 / 22,1	3.859 / 35,8	4,2
1.694	3.016 / 25,5	4.785 / 41,1	2.926 / 25,5	4.502 / 41,1	4,9
1.934	3.446 / 28,7	5.469 / 46,3	3.344 / 28,7	5.146 / 46,3	5,4
2.174	3.877 / 32,0	6.152 / 52,0	3.762 / 32,0	5.789 / 52,0	6,1
2.414	4.308 / 35,4	6.836 / 57,3	4.180 / 35,4	6.432 / 57,3	6,8
2.894	5.170 / 41,6	8.203 / 69,6	5.016 / 41,6	7.718 / 69,6	8,0
3.134	5.600 / 44,8	8.887 / 75,5	5.434 / 44,8	8.362 / 75,5	8,6
3.856	6.892 / 57,4	10.938 / 92,6	6.688 / 57,4	10.292 / 92,6	10,8

Alle Lumenangaben für 4000K, CRI>80, Microprisma ohne Opalfolie

All lumen values for 4000K, CRI>80, microprism without opal foil

Toutes les données de lumens pour 4000K, CRI>80, microprisme sans feuille opale

RING50

ANBAULEUCHTE | SURFACE MOUNTED LUMINAIRE | LUMINAIRE EN SAILLIE

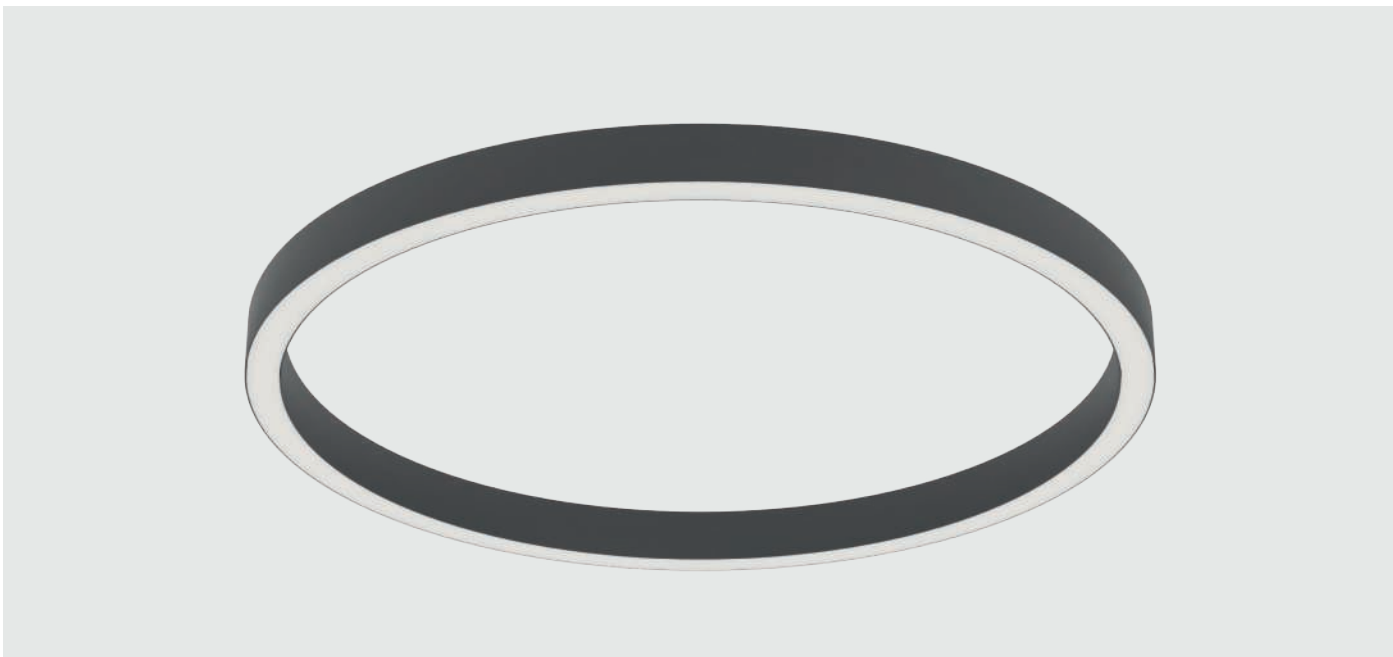

Ringförmige LED-Anbauleuchte direktstrahlend. Lichtkanal aus gerolltem Aluminiumprofil mit einer Breite von 50 mm. Leuchte erhältlich in neun verschiedenen Durchmessern – 1220 und 1575 mm in einem Stück nahtlos verschweißt – die restlichen Größen (2020, 2595, 3090, 3535, 4070, 5050, 6075 mm) bestehend aus zwei bis neun gleich großen Segmenten. Oberfläche der Leuchte feinstruktur matt pulverbeschichtet ähnlich RAL 9016 weiß, RAL 9006 silber oder RAL 9005 schwarz – auf Anfrage in RAL nach Wahl. Diffusor wahlweise in PMMA opal oder PMMA klar mit mikroprismatischer Prägung für eine reduzierte Leuchtdichte (UGR<19). Der LED-Treiber ist im Leuchtgehäuse integriert – wahlweise als on/off oder DALI-Variante. Farbtemperaturen 2700K, 3000K, 4000K oder dynamisch Weiß (2700K–6500K) – Farbwiedergabe CRI>80 oder CRI>90 – Mac Adam ≤3. Weitere Steuerungsoptionen oder Lichtfarben auf Anfrage erhältlich. Außerdem ist die Integration vieler Komponenten, wie beispielsweise Notlicht oder Sensortechnologie, sowie eine Vielzahl weiterer Optionen möglich.

Ring-shaped surface mounted LED luminaire with direct beam. Light channel made of rolled aluminium profile with a width of 50 mm. Luminaire available in nine different diameters - 1220 and 1575 mm seamlessly welded in one piece - the remaining sizes (2020, 2595, 3090, 3535, 4070, 5050, 6075 mm) consisting of two to nine equally sized segments. Surface of the luminaire fine structure matt powder coated similar to RAL 9016 white, RAL 9006 silver or RAL 9005 black - on request in RAL of choice. Diffuser either in PMMA opal or PMMA clear with microprismatic pattern for reduced luminance (UGR<19). The LED driver is integrated in the luminaire housing - either as on/off or DALI version. Colour temperatures 2700K, 3000K, 4000K or dynamic white (2700K-6500K) - colour rendering CRI>80 or CRI>90 - Mac Adam ≤3. Further control options or light colours available on request. In addition, the integration of many components, such as emergency lighting or sensor technology, as well as a variety of other options is possible.

Luminaire LED en saillie en forme d'anneau à éclairage direct. Canal lumineux en profilé d'aluminium roulé d'une largeur de 50 mm. Luminaire disponible en neuf diamètres différents - 1220 et 1575 mm en une seule pièce soudée sans soudure - les autres tailles (2020, 2595, 3090, 3535, 4070, 5050, 6075 mm) se composent de deux à neuf segments de même taille. Surface du luminaire à structure fine matte revêtue par poudre similaire à RAL 9016 blanc, RAL 9006 argent ou RAL 9005 noir - sur demande en RAL au choix. Diffuseur au choix en PMMA opale ou en PMMA transparent avec gaufrage microprismatique pour un éblouissement réduit (UGR<19). Le driver LED est intégré dans le boîtier du luminaire - au choix en version on/off ou DALI. Températures de couleur 2700K, 3000K, 4000K ou blanc dynamique (2700K-6500K) - Rendu des couleurs CRI>80 ou CRI>90 - Mac Adam ≤3. Autres options de commande ou couleurs de lumière disponibles sur demande. En outre, l'intégration de nombreux composants, tels que l'éclairage de secours ou la technologie de détection, une multitude d'autres options sont possibles.

ÜBERSICHT | OVERVIEW | VUE D'ENSEMBLE

TECHNICAL DATA

2700K / 3000K / 4000K / 2700-6500K

CRI>80 / CRI>90

MacAdam ≤ 3

up to 131 lm/W

on-off / DALI

direct

opal / microprism (UGR <19)

L80 B10 50.000h

HOUSING COLOUR

schwarz | black | noir
RAL 9005

silber | silver | argent
RAL 9006

weiß | white | blanc
RAL 9016



RAL colour of your choice



Integration of emergency light



Contact us for more options...

ANBAULEUCHTE „RING50“
 SURFACE MOUNTED LUMINAIRE “RING50”
 LUMINAIRE EN SAILLIE « RING50 »

Bestellbeispiel | Example order | Exemple de commande
 6.075 mm, CRI>90, 4000K, **direct**, low output on/off, black, microprism

RG50A-609401-LOBLM

1 2 3 4 5 6

1 DURCHMESSER DIAMETER DIAMÈTRE	
1.220 mm (no DW)	12
1.575 mm (no DW)	15
2.020 mm	20
2.595 mm	25
3.090 mm	30
3.535 mm	35
4.070 mm	40
5.050 mm	50
6.075 mm	60

2 FARBWIEDERGABE COLOUR RENDERING RENDU DES COULEURS	
CRI>80	8
CRI>90	9

3 FARBTEMPERATUR COLOUR TEMPERATURE TEMPÉRATURE DE COULEUR	
2700K (CRI>90 only)	27
3000K	30
4000K	40
2700-6500K (CRI>90 only)	DW

4 LEISTUNG & STEUERUNG OUTPUT & CONTROL SORTIE & CONTRÔLE	
low output on/off	LO
low output DALI	LD
high output on/off	HO
high output DALI	HD
dynamic white DALI DT8	DW

5 GEHÄUSEFARBE HOUSING COLOUR COULEUR DU BOÎTIER	
silver RAL 9006	SI
white RAL 9016	WH
black RAL 9005	BL

6 DIFFUSOR DIFFUSER DIFFUSEUR	
opal	O
microprism	M

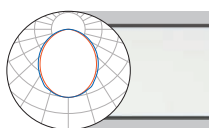
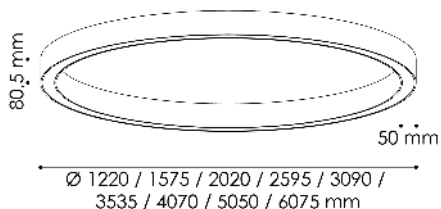

opal
direct

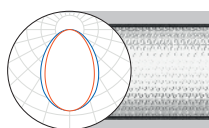

microprism
direct

Size [mm]	opal direct		microprism direct		KG
	low output [lm] / [W]	high output [lm] / [W]	low output [lm] / [W]	high output [lm] / [W]	
Ø 1.220	4.888 / 38,3	8.376 / 66,3	5.026 / 38,3	8.616 / 66,3	9,9
Ø 1.575	6.110 / 51,2	10.470 / 86,6	6.283 / 51,2	10.770 / 86,6	12,8
Ø 2.020	7.943 / 65,0	13.611 / 113,2	8.168 / 65,0	14.001 / 113,2	16,5
Ø 2.595	10.387 / 85,0	17.799 / 147,9	10.681 / 85,0	18.309 / 147,9	21,1
Ø 3.090	12.220 / 102,4	20.940 / 178,0	12.566 / 102,4	21.540 / 178,0	25,2
Ø 3.535	14.053 / 120,7	24.081 / 209,0	14.451 / 120,7	24.771 / 209,0	28,8
Ø 4.070	15.886 / 137,0	27.222 / 238,0	16.336 / 137,0	28.002 / 238,0	33,2
Ø 5.050	20.163 / 172,0	34.551 / 298,0	20.734 / 172,0	35.541 / 298,0	41,1
Ø 6.075	23.829 / 205,5	40.833 / 357,0	24.504 / 205,5	42.003 / 357,0	49,5

Alle Lumenangaben für 4000K, CRI>80, Gehäusefarbe weiß
 All lumen values for 4000K, CRI>80, housing colour white
 Toutes les données de lumens pour 4000K, CRI>80, couleur du boîtier blanc

RING50mute

ANBAULEUCHTE | SURFACE MOUNTED LUMINAIRE | LUMINAIRE EN SAILLIE



Ringförmige LED-Anbauleuchte direktstrahlend. Lichtkanal aus gerolltem Aluminiumprofil mit einer Breite von 50 mm. Leuchte erhältlich in zwei verschiedenen Durchmessern mit integrierten Akustikelemente – 1220 und 1575 mm in einem Stück nahtlos verschweißt. Oberfläche der Leuchte feinstruktur matt pulverbeschichtet ähnlich RAL 9016 weiß, RAL 9006 silber oder RAL 9005 schwarz – auf Anfrage in RAL nach Wahl. Akustikelemente aus recyceltem PET in schwarz, hellgrau meliert, anthrazit meliert, burgunderrot oder olivgrün auswählbar. Diffusor wahlweise in PMMA opal oder PMMA klar mit mikroprismatischer Prägung für eine reduzierte Leuchtdichte (UGR<19). Der LED-Treiber ist im Leuchtgehäuse integriert – wahlweise als on/off oder DA- LI-Variante. Farbtemperaturen 2700K, 3000K oder 4000K – Farbwiedergabe CRI>80 oder CRI>90 – Mac Adam ≤3. Weitere Steuerungsoptionen oder Lichtfarben auf Anfrage erhältlich. Außerdem ist die Integration vieler Komponenten, wie beispielsweise Notlicht oder Sensortechnologie, sowie eine Vielzahl weiterer Optionen möglich.

Ring-shaped surface mounted LED luminaire with direct beam. Light channel made of rolled aluminium profile with a width of 50 mm. Luminaire available in two different diameters with integrated acoustic elements - 1220 and 1575 mm seamlessly welded in one piece. Surface of the luminaire fine structure matt powder coated similar to RAL 9016 white, RAL 9006 silver or RAL 9005 black - on request in RAL of choice. Acoustic elements made of recycled PET available in black, light grey mottled, anthracite mottled, burgundy red or olive green. Diffuser either in PMMA opal or PMMA clear with microprismatic pattern for reduced luminance (UGR<19). The LED driver is integrated in the luminaire housing - either as on/ off or DALI version. Colour temperatures 2700K, 3000K or 4000K - colour rendering CRI>80 or CRI>90 - Mac Adam ≤3. Further control options or light colours available on request. In addition, the integration of many components, such as emergency lighting or sensor technology, as well as a variety of other options is possible.

Luminaire LED en saillie en forme d'anneau à éclairage direct ou direct-indirect. Canal lumineux en profilé d'aluminium roulé d'une largeur de 50 mm. Luminaire disponible en deux diamètres différents avec élément acoustique intégré - 1220 et 1575 mm en une seule pièce soudée sans soudure. Surface du luminaire à structure fine matte revêtue par poudre similaire à RAL 9016 blanc, RAL 9006 argent ou RAL 9005 noir - sur demande en RAL au choix. Éléments acoustiques fabriqués en PET recyclé en noir, gris clair chiné, anthracite chiné, rouge bordeaux ou vert olive au choix. Diffuseur au choix en PMMA opale ou en PMMA transparent avec gaufrage microprismatique pour un éblouissement réduit (UGR<19). Le pilote LED est intégré dans le boîtier du luminaire - au choix en version on/off ou DALI. Températures de couleur 2700K, 3000K ou 4000K - Rendu des couleurs CRI>80 ou CRI>90 - Mac Adam ≤3. Autres options de commande ou couleurs de lumière disponibles sur demande. En outre, l'intégration de nombreux composants, tels que l'éclairage de secours ou la technologie de détection, une multitude d'autres options sont possibles.

ÜBERSICHT | OVERVIEW | VUE D'ENSEMBLE

TECHNICAL DATA

2700K / 3000K / 4000K

CRI>80 / CRI>90

MacAdam ≤ 3

up to 131 lm/W

on-off / DALI

direct

opal / microprism (UGR <19)

L80 B10 50.000h

acoustic material - fire classification: B-s2, d0 (EN13501-1:3018)

HOUSING COLOUR

schwarz | black | noir
RAL 9005

silber | silver | argent
RAL 9006

weiß | white | blanc
RAL 9016



RAL colour of your choice



Integration of emergency light



Contact us for more options...

COLOUR ACOUSTIC PANEL

schwarz | black | noir

hellgrau meliert | light grey mottled|
gris clair chiné

anthrazit meliert | anthracite mottled|
anthracite chiné

burgunderrot | burgundy red | rouge bourgogne

olivgrün | olive green | vert olive

ANBAULEUCHTE „RING50mute“
 SURFACE MOUNTED LUMINAIRE “RING50mute”
 LUMINAIRE EN SAILLIE « RING50mute »

Bestellbeispiel | Example order | Exemple de commande
 1.220 mm, CRI90, 4000K, **direct**, low output on/off, black, olive, microprism

RG5MA-129401-LOBOM

1 2 3 4 5 6 7

1 DURCHMESSER
DIAMETER
DIAMÈTRE

1.220 mm	12
1.575 mm	15

2 FARBWIEDERGABE
COLOUR RENDERING
RENDU DES COULEURS

CRI>80	8
CRI>90	9

3 FARBTEMPERATUR
COLOUR TEMPERATURE
TEMPÉRATURE DE COULEUR

2700K (CRI>90 only)	27
3000K	30
4000K	40

4 LEISTUNG & STEUERUNG
OUTPUT & CONTROL
SORTIE & CONTRÔLE

low output on/off	LO
low output DALI	LD
high output on/off	HO
high output DALI	HD

5 GEHÄUSEFARBE
HOUSING COLOUR
COULEUR DU BOÎTIER

silver RAL 9006	S
white RAL 9016	W
black RAL 9005	B

6 FARBE AKUSTIKPLATTE
COLOUR ACOUSTIC PANEL
COULEUR PANNEAU ACOUSTIQUE

black	B
light grey mottled	S
anthracite mottled	A
burgundy red	R
olive green	O

6 DIFFUSOR
DIFFUSER
DIFFUSEUR

opal	O
microprism	M

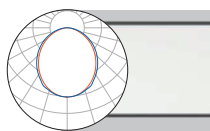
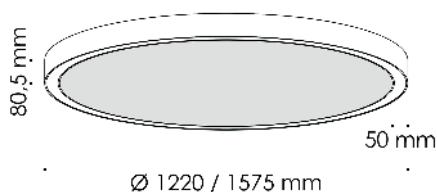

opal
direct

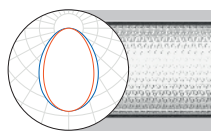

microprism
direct

Size [mm]	low output [lm] / [W]	high output [lm] / [W]	low output [lm] / [W]	high output [lm] / [W]	 [kg]
Ø 1.220	4.888 / 38,3	8.376 / 66,3	5.026 / 38,3	8.616 / 66,3	14,0
Ø 1.575	6.110 / 51,2	10.470 / 86,6	6.283 / 51,2	10.770 / 86,6	19,8

Alle Lumenangaben für 4000K, CRI>80, Gehäusefarbe weiß
 All lumen values for 4000K, CRI>80, housing colour white
 Toutes les données de lumens pour 4000K, CRI>80, couleur du boîtier blanc

FLEX50

ANBAULEUCHTE | SURFACE MOUNTED LUMINAIRE | LUMINAIRE EN SAILLIE



LED-Anbauleuchte als Segment zur individuellen Kombination. Direktstrahlend. Lichtkanal aus gerolltem Aluminiumprofil mit einer Breite von 50 mm. Segmente erhältlich in 13 verschiedenen Varianten – zwei Stück als gerades Profil 980 oder 1960 mm – die restlichen Segmente sind als 40°, 45°, 60°- bzw. 90°-Stücke mit einem Mittelradius von 585 bis 3012,5 mm erhältlich. Oberfläche der Leuchte feinstruktur matt pulverbeschichtet ähnlich RAL 9016 weiß, RAL 9006 silber oder RAL 9005 schwarz – auf Anfrage in RAL nach Wahl. Diffusor wahlweise in PMMA opal oder PMMA mit mikroprismatischer Prägung für eine reduzierte Leuchtdichte (UGR<19). Der LED-Treiber ist im Leuchtgehäuse integriert – wahlweise als on/off oder DALI-Variante. Farbtemperaturen 2700K, 3000K, 4000K oder dynamisch Weiß (2700K–6500K) – Farbwiedergabe CRI>80 oder CRI>90 – Mac Adam ≤3. Weitere Steuerungsoptionen oder Lichtfarben auf Anfrage erhältlich. Außerdem ist die Integration vieler Komponenten, wie beispielsweise Notlicht oder Sensortechnologie, sowie eine Vielzahl weiterer Optionen möglich.

Surface mounted LED luminaire as segment for individual combination. Direct beam. Light channel made of rolled aluminium profile with a width of 50 mm. Segments available in 13 different versions - two pieces as straight profile 980 or 1960 mm - the remaining segments are available as 40°, 45°, 60° or 90° pieces with a middle radius of 585 to 3012.5 mm. Surface of the luminaire fine structure matt powder coated similar to RAL 9016 white, RAL 9006 silver or RAL 9005 black - on request in RAL of choice. Diffuser either in PMMA opal or PMMA clear with microprismatic pattern for reduced luminance (UGR<19). The LED driver is integrated in the luminaire housing - either as on/off or DALI version. Colour temperatures 2700K, 3000K, 4000K or dynamic white (2700K-6500K) - colour rendering CRI>80 or CRI>90 - Mac Adam ≤3. Further control options or light colours available on request. In addition, the integration of many components, such as emergency lighting or sensor technology, as well as a variety of other options is possible.

Luminaire LED en saillie a segment pour une combinaison individuelle. Éclairage direct de la surface. Canal lumineux en profilé d'aluminium roulé d'une largeur de 50 mm. Segments disponibles en 13 variantes différentes - deux pièces en tant que profil droit de 980 ou 1960 mm - les autres segments sont disponibles en tant que pièces de 40°, 45°, 60° ou 90° avec un rayon central de 585 à 3012,5 mm. Surface du luminaire à structure fine matte revêtue par poudre similaire à RAL 9016 blanc, RAL 9006 argent ou RAL 9005 noir - sur demande en RAL au choix. Diffuseur au choix en PMMA opale ou en PMMA transparent avec gaufrage microprismatique pour un éblouissement réduit (UGR<19). Le driver LED est intégré dans le boîtier du luminaire - au choix en version on/off ou DALI. Températures de couleur 2700K, 3000K, 4000K ou blanc dynamique (2700K-6500K) - Rendu des couleurs CRI>80 ou CRI>90 - Mac Adam ≤3. Autres options de commande ou couleurs de lumière disponibles sur demande. En outre, l'intégration de nombreux composants, tels que l'éclairage de secours ou la technologie de détection, une multitude d'autres options sont possibles.

ÜBERSICHT | OVERVIEW | VUE D'ENSEMBLE

TECHNICAL DATA

2700K / 3000K / 4000K / 2700-6500K

CRI>80 / CRI>90

MacAdam ≤ 3

up to 131 lm/W

on-off / DALI

direct

opal / microprism (UGR <19)

L80 B10 50.000h

HOUSING COLOUR

schwarz | black | noir
RAL 9005

silber | silver | argent
RAL 9006

weiß | white | blanc
RAL 9016



RAL colour of your choice



Integration of emergency light



Contact us for more options...

ANBAULEUCHTE „FLEX50“
 SURFACE MOUNTED LUMINAIRE “FLEX50”
 LUMINAIRE EN SAILLIE « FLEX50 »

Bestellbeispiel | Example order | Exemple de commande
 straight, 1.960 mm, CRI>90, 4000K, **direct**, low output on/off, black, microprism

FX50A-L29401-LOBLM

1 2 3 4 5 6

1 GRÖSSE SIZE TAILLE	
straight, L 980 mm	L1
straight, L 1.960 mm	L2
90°, R 585 mm (no DW)	19
90°, R 762,5 mm (no DW)	29
90°, R 985 mm	39
45°, R 1.272,5 mm	44
90°, R 1.272,5 mm	49
60°, R 1.520 mm	56
90°, R 1.520 mm	59
60°, R 1.742,5 mm	66
60°, R 2.010 mm	76
45°, R 2.500 mm	84
40°, R 3.012,5 mm	94

2 FARBWIEDERGABE COLOUR RENDERING RENDU DES COULEURS	
CRI>80	8
CRI>90	9

3 FARBTemperatur COLOUR TEMPERATURE TEMPÉRATURE DE COULEUR	
2700K (CRI>90 only)	27
3000K	30
4000K	40
2700-6500K (CRI>90 only)	DW

4 LEISTUNG & STEUERUNG OUTPUT & CONTROL SORTIE & CONTRÔLE	
low output on/off	LO
low output DALI	LD
high output on/off	HO
high output DALI	HD
dynamic white DALI DT8	DW

5 GEHÄUSEFARBE HOUSING COLOUR COULEUR DU BOÎTIER	
silver RAL 9006	SI
white RAL 9016	WH
black RAL 9005	BL

6 DIFFUSOR DIFFUSER DIFFUSEUR	
opal	O
microprism	M

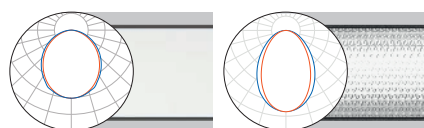
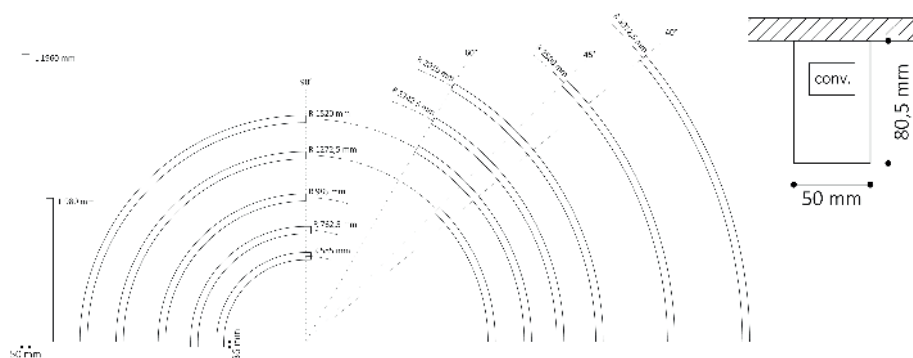

ACCESSORIES	
END CAPS - 2 pcs.	
black	FX50A-EC-BL
silver	FX50A-EC-SI
white	FX50A-EC-WH

Size [mm]	opal direct		microprism direct		kg
	low output [lm] / [W]	high output [lm] / [W]	low output [lm] / [W]	high output [lm] / [W]	
straight, L 980	1.222 / 11,2	2.094 / 18,1	1.257 / 11,2	2.153 / 18,1	2,6
straight, L 1.960	2.554 / 23,3	4.377 / 37,8	2.626 / 23,3	4.377 / 37,8	5,3
90°, R 585	1.224 / 9,6	2.096 / 16,6	1.256 / 9,6	2.156 / 16,6	2,6
90°, R 762,5	1.530 / 12,8	2.620 / 21,6	1.570 / 12,8	2.695 / 21,6	3,3
90°, R 985	1.836 / 16,3	3.144 / 28,3	1.884 / 16,3	3.234 / 28,3	4,3
45°, R 1.272,5	1.224 / 10,6	2.096 / 18,5	1.256 / 10,6	2.156 / 18,5	2,7
90°, R 1.272,5	2.448 / 21,3	4.192 / 37,0	2.512 / 21,3	4.312 / 37,0	5,5
60°, R 1.520	1.836 / 17,1	3.144 / 29,6	1.884 / 17,1	3.234 / 29,6	4,3
90°, R 1.520	3.060 / 25,6	5.240 / 44,5	3.140 / 25,6	5.390 / 44,5	6,5
60°, R 1.742,5	2.142 / 20,1	3.668 / 34,8	2.198 / 20,1	3.773 / 34,8	5,0
60°, R 2.010	2.754 / 22,8	4.716 / 39,7	2.826 / 22,8	4.851 / 39,7	5,7
45°, R 2.500	2.448 / 21,5	4.192 / 37,2	2.512 / 21,5	4.312 / 37,2	5,3
40°, R 3.012,5	2.754 / 22,8	4.716 / 39,7	2.826 / 22,8	4.851 / 39,7	5,7

Alle Lumenangaben für 4000K, CRI>80, Gehäusefarbe weiß
 All lumen values for 4000K, CRI>80, housing colour white
 Toutes les données de lumens pour 4000K, CRI>80, couleur du boîtier blanc

OVOID50

ANBAULEUCHTE | SURFACE MOUNTED LUMINAIRE | LUMINAIRE EN SAILLIE

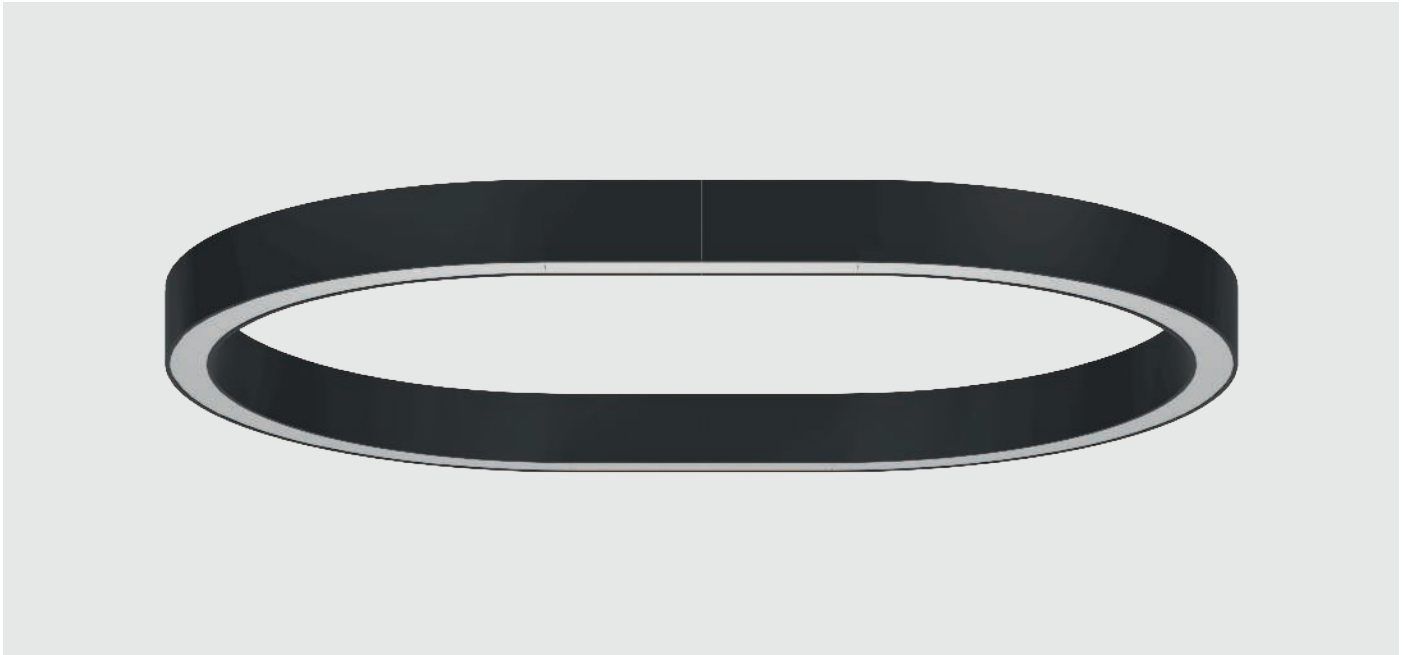

LED-Anbauleuchte als ovalförmige Standardleuchte. Direktstrahlend. Lichtkanal aus gerolltem Aluminiumprofil mit einer Breite von 50 mm. Ovale Standardleuchte erhältlich mit den Abmessungen 1.160 mm x 850 mm oder 2.500 mm x 1.800 mm. Oberfläche der Leuchte feinstruktur matt pulverbeschichtet ähnlich RAL 9016 weiß, RAL 9006 silber oder RAL 9005 schwarz – auf Anfrage in RAL nach Wahl. Diffusor wahlweise in PMMA opal oder PMMA mit mikroprismatischer Prägung für eine reduzierte Leuchtdichte (UGR<19) Der LED-Treiber ist im Leuchtgehäuse integriert – wahlweise als on/off oder DALI-Variante. Farbtemperaturen 2700K, 3000K, 4000K oder dynamisch Weiß (2700K-6500K) – Farbwiedergabe CRI>80 oder CRI>90 – Mac Adam ≤ 3. Weitere Steuerungsoptionen oder Lichtfarben auf Anfrage erhältlich. Außerdem ist die Integration vieler Komponenten, wie beispielsweise Notlicht oder Sensortechnologie, sowie eine Vielzahl weiterer Optionen möglich.

Surface mounted LED luminaire in an oval-shaped standard design. Direct beam. Light channel made of rolled aluminium profile with a width of 50 mm. Oval standard luminaire available in dimensions 1.160 mm x 850 mm or 2.500 mm x 1.800 mm. Surface of the luminaire fine structure matt powder coated similar to RAL 9016 white, RAL 9006 silver or RAL 9005 black - on request in RAL of choice. Diffuser either in PMMA opal or PMMA clear with microprismatic pattern for reduced luminance (UGR<19). The LED driver is integrated in the luminaire housing - either as on/off or DALI version. Colour temperatures 2700K, 3000K, 4000K or dynamic white (2700K-6500K) - colour rendering CRI>80 or CRI>90 - Mac Adam ≤3. Further control options or light colours available on request. In addition, the integration of many components, such as emergency lighting or sensor technology, as well as a variety of other options is possible.

Luminaire LED en saillie au design standard en forme ovale. Éclairage direct de la surface. Luminaire standard ovale disponible dans les dimensions 1.160 mm x 850 mm ou 2.500 mm x 1.800 mm. Surface du luminaire à structure fine matte revêtue par poudre similaire à RAL 9016 blanc, RAL 9006 argent ou RAL 9005 noir - sur demande en RAL au choix. Diffuseur au choix en PMMA opale ou en PMMA transparent avec gaufrage microprismatique pour un éblouissement réduit (UGR<19). Le driver LED est intégré dans le boîtier du luminaire - au choix en version on/ off ou DALI. Températures de couleur 2700K, 3000K, 4000K ou blanc dynamique (2700K-6500K) - Rendu des couleurs CRI>80 ou CRI>90 - Mac Adam ≤3. Autres options de commande ou couleurs de lumière disponibles sur demande. En outre, l'intégration de nombreux composants, tels que l'éclairage de secours ou la technologie de détection, une multitude d'autres options sont possibles.

ÜBERSICHT | OVERVIEW | VUE D'ENSEMBLE

TECHNICAL DATA

2700K / 3000K / 4000K / 2700-6500K

CRI>80 / CRI>90

MacAdam ≤ 3

up to 112 lm/W

on-off / DALI

direct

opal / microprism (UGR <19)

L80 B10 50.000h

HOUSING COLOUR

schwarz | black | noir
RAL 9005

silber | silver | argent
RAL 9006

weiß | white | blanc
RAL 9016



RAL colour of your choice



Integration of emergency light



Contact us for more options...

ANBAULEUCHTE „OVOID50“
 SURFACE MOUNTED LUMINAIRE “OVOID50”
 LUMINAIRE EN SAILLIE « OVOID50 »

Bestellbeispiel | Example order | Exemple de commande
 1160x850 mm, CRI90, 4000K, **direct**, low output on/off, black, microprism

OV50A-119401-LOBLM

1 2 3 4 5 6

1 GRÖSSE
 SIZE
 TAILLE

L 1160 mm, W 850 mm	11
L 2500 mm, W 1800 mm	25

2 FARBWIEDERGABE
 COLOUR RENDERING
 RENDU DES COULEURS

CRI>80	8
CRI>90	9

3 FARBTEMPERATUR
 COLOUR TEMPERATURE
 TEMPÉRATURE DE COULEUR

2700K (CRI>90 only)	27
3000K	30
4000K	40
2700-6500K (CRI>90 only)	DW

4 LEISTUNG & STEUERUNG
 OUTPUT & CONTROL
 SORTIE & CONTRÔLE

low output on/off	LO
low output DALI	LD
high output on/off	HO
high output DALI	HD
dynamic white DALI DT8	DW

5 GEHÄUSEFARBE
 HOUSING COLOUR
 COULEUR DU BOÎTIER

silver RAL 9006	SI
white RAL 9016	WH
black RAL 9005	BL

6 ABDECKUNG
 COVER
 COUVERTURE

opal	O
microprism	M

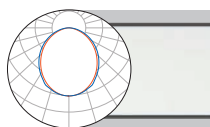
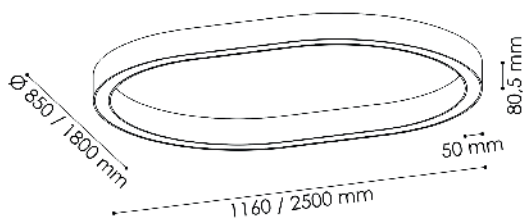

opal
direct

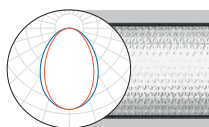

microprism
direct

Size [mm]	low output [lm] / [W]	high output [lm] / [W]	low output [lm] / [W]	high output [lm] / [W]	
1.160 x 850	3.455 / 32,5	5.527 / 57,0	3.656 / 32,5	5.899 / 57,0	8,3
2.500 x 1.800	7.539 / 71,0	12.060 / 124,4	7.977 / 71,0	12.869 / 124,4	17,7

Alle Lumenangaben für 4000K, CRI>80, Gehäusefarbe weiß

All lumen values for 4000K, CRI>80, housing colour white

Toutes les données de lumens pour 4000K, CRI>80, couleur du boîtier blanc

ROUND90

ANBAULEUCHTE | SURFACE MOUNTED LUMINAIRE | LUMINAIRE EN SAILLIE



Runde LED-Flächenleuchte zur Anbaumontage. Direktstrahlend oder direkt-indirektstrahlend. Gehäuse aus gerolltem Aluminiumprofil, nahtlos verschweißt. Fertigung der Leuchte in vier Durchmessern: 350, 450, 650 und 950 mm mit einer Gesamthöhe von 90 mm. Oberfläche pulverbeschichtet feinstruktur matt ähnlich RAL 9016 weiß, RAL 9006 silber oder RAL 9005 schwarz – auf Anfrage in RAL nach Wahl. Die durchdachte Konstruktion der Leuchte ermöglicht ein Design in zahlreichen Farbkombinationen – zwischen Gehäusefarbe und Dekorring kann beliebig kombiniert werden. Um der Leuchtenfamilie neben den Standardfarben einen dekorativen Touch zu verleihen, steht der Dekorring auch in den strukturierten Spezialoberflächen schlaggold, schlagsilber und schlagbronze zur Auswahl. Diffusor in PMMA wahlweise opal, mikroprismatisch inkl. Streufolie oder nur mikroprismatisch (office special) für eine reduzierte Leuchtdichte (UGR<19). Einfache Montage durch Einschieben des Leuchtgehäuses in den Baldachin. Der LED-Treiber ist im Leuchtgehäuse integriert – wahlweise als on/off oder DALI-Variante. Farbtemperaturen 2700K, 3000K, 4000K oder dynamisch Weiß (2700K–6500K) – Farbwiedergabe CRI>80 oder CRI>90 – Mac Adam ≤3. Weitere Steuerungsoptionen oder Lichtfarben auf Anfrage möglich. Außerdem ist die Integration vieler Komponenten, wie beispielsweise Notlicht oder Sensortechnologie, sowie eine Vielzahl weiterer Optionen möglich.

Round surface mounted LED luminaire. Direct beam or direct-indirect beam. Housing made of rolled aluminium profile, seamlessly welded. Luminaire manufactured in four diameters: 350, 450, 650 and 950 mm with a total height of 90 mm. Surface powder coated fine structure matt similar to RAL 9016 white, RAL 9006 silver or RAL 9005 black - on request in RAL of choice. The sophisticated construction of the luminaire allows a design in numerous colour combinations - any combination of housing colour and decorative ring is possible. To give the luminaire family a decorative touch in addition to the standard colours, the decorative ring is also available in the special textured surfaces beaten gold, beaten silver and beaten bronze. Diffuser in PMMA either opal, microprism incl. diffuser foil or only microprism (office special) for reduced luminance (UGR<19). Easy installation by sliding the luminaire housing into the canopy. The LED driver is integrated in the luminaire housing - either as on/off or DALI version. Colour temperatures 2700K, 3000K, 4000K or dynamic white (2700K-6500K) - colour rendering CRI>80 or CRI>90 - Mac Adam ≤3. Further control options or light colours available on request. In addition, the integration of many components, such as emergency lighting or sensor technology, as well as a variety of other options is possible.

Luminaire LED rond en saillie. Éclairage direct ou éclairage direct-indirect. Boîtier en profilé d'aluminium roulé, soudé sans soudeuse. Fabrication du luminaire en quatre diamètres : 350, 450, 650 et 950 mm avec une hauteur totale de 90 mm. Surface revêtue par poudre à structure fine mate similaire à RAL 9016 blanc, RAL 9006 argent ou RAL 9005 noir - sur demande en RAL au choix. La construction bien pensée du luminaire permet un design dans de nombreuses combinaisons de couleurs - il est possible de combiner à volonté entre la couleur du boîtier et l'anneau décoratif. Pour donner à la famille de luminaires une touche décorative en plus des couleurs standard, l'anneau décoratif est également disponible dans les surfaces spéciales structurées or choc, argent choc et bronze choc. Diffuseur en PMMA au choix opale, microprismatique y compris feuille diffuseuse ou uniquement microprismatique (office special) pour un éblouissement réduit (UGR<19). Montage facile en insérant le corps du luminaire dans le canopy. Le driver LED est intégré dans le boîtier du luminaire - au choix en version on/off ou DALI. Températures de couleur 2700K, 3000K, 4000K ou blanc dynamique (2700K-6500K) - Rendu des couleurs CRI>80 ou CRI>90 - Mac Adam ≤3. Autres options de commande ou couleurs de lumière possibles sur demande. En outre, l'intégration de nombreux composants, tels que l'éclairage de secours ou la technologie des capteurs, une multitude d'autres options sont possibles.

ÜBERSICHT | OVERVIEW | VUE D'ENSEMBLE

TECHNICAL DATA

2700K / 3000K / 4000K / 2700-6500K

CRI>80 / CRI>90

MacAdam ≤ 3

up to 174 lm/W

on-off / DALI

direct / direct + indirect

opal / microprism / office special (UGR <19)

L80 B10 50.000h



RAL colour of your choice



Integration of Multisensor



Integration of emergency light



Contact us for more options...

HOUSING COLOUR

schwarz | black | noir
RAL 9005



silber | silver | argent
RAL 9006



weiß | white | blanc
RAL 9016



DECORATION RING COLOUR

schwarz | black | noir
RAL 9005



schlaggold | beaten gold | or texturés



silber | silver | argent
RAL 9006



schlagsilber | beaten silver | argent texturés



weiß | white | blanc
RAL 9016



schlagbronze | beaten bronze | bronze texturés



ANBAULEUCHTE „ROUND90“

SURFACE MOUNTED LUMINAIRE “ROUND90”
LUMINAIRE EN SAILLIE « ROUND90 »

Bestellbeispiel | Example order | Exemple de commande

350 mm, CRI>90, 4000K, direct, low output on/off, black, beaten gold, microprism

RO90A-359401-LOBGM

1 2 3 4 5 6 7 8

1	DURCHMESSER DIAMETER DIAMÈTRE	
	350 mm	35
	450 mm	45
	650 mm	65
	950 mm	95
2	FARBWIEDERGABE COLOUR RENDERING RENDU DES COULEURS	
	CRI>80	8
	CRI>90	9
3	FARBTEMPERATUR COLOUR TEMPERATURE TEMPÉRATURE DE COULEUR	
	2700K (CRI>90 only)	27
	3000K	30
	4000K	40
	2700-6500K (CRI>90 only)	DW

4	LICHTVERTEILUNG LIGHT DISTRIBUTION DISTRIBUTION DE LA LUMIÈRE	
	direct	1
	direct + indirect	2
5	LEISTUNG & STEUERUNG OUTPUT & CONTROL SORTIE & CONTRÔLE	
	low output on/off	LO
	low output DALI	LD
	high output on/off	HO
	high output DALI	HD
	dynamic white DALI DT8	DW
6	GEHÄUSEFARBE HOUSING COLOUR COULEUR DU BOÎTIER	
	silver RAL 9006	S
	white RAL 9016	W
	black RAL 9005	B

7	DEKORRING FARBE DECORATION RING COLOUR BAGUE DÉCORATIVE COULEUR	
	silver RAL 9006	S
	white RAL 9016	W
	black RAL 9005	B
	beaten gold	G
	beaten silver	A
	beaten bronze	C
8	DIFFUSOR DIFFUSER DIFFUSEUR	
	opal	O
	microprism	M
	office special	B

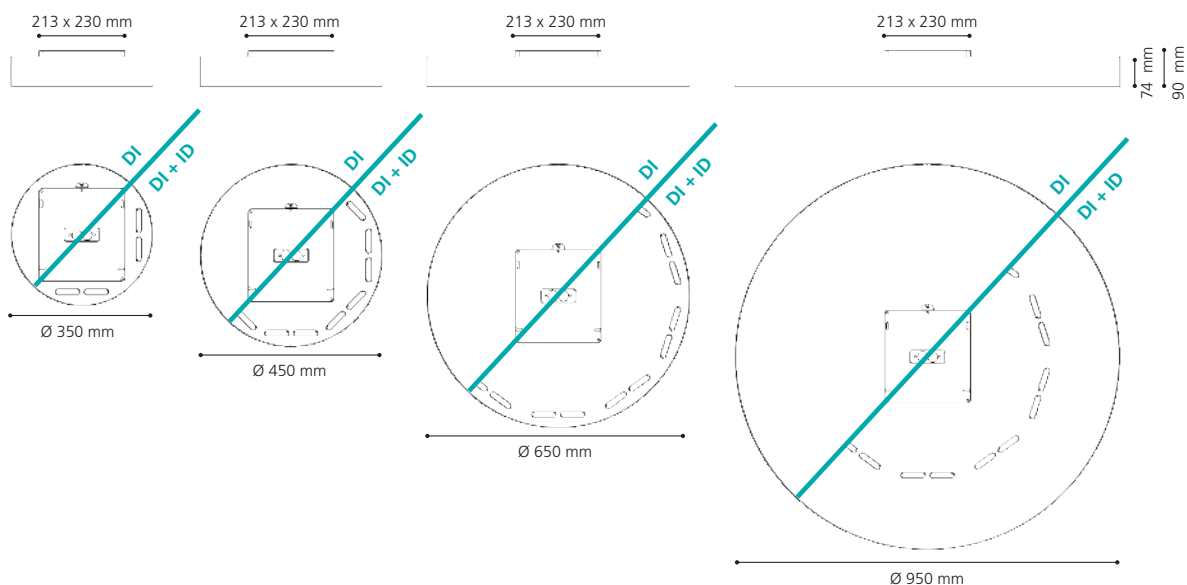

Size [mm]	opal direct		microprism direct		office special direct		opal direct + indirect		microprism direct + indirect		office special direct + indirect		kg
	low output [lm] / [W]	high output [lm] / [W]	low output [lm] / [W]	high output [lm] / [W]	low output [lm] / [W]	high output [lm] / [W]	low output [lm] / [W]	high output [lm] / [W]	low output [lm] / [W]	high output [lm] / [W]	low output [lm] / [W]	high output [lm] / [W]	
Ø 350	1.158 / 8,5	1.826 / 12,9	1.077 / 8,5	1.697 / 12,9	1.213 / 8,5	1.905 / 12,9	1.747 / 11,9	2.625 / 17,5	1.661 / 11,9	2.493 / 17,5	1.795 / 11,9	2.691 / 17,5	3,4
Ø 450	2.258 / 15,5	3.561 / 23,5	2.099 / 15,5	3.309 / 23,5	2.364 / 15,5	3.715 / 23,5	3.207 / 20,7	4.820 / 30,3	3.050 / 20,7	4.577 / 30,2	3.296 / 20,7	4.942 / 30,3	4,0
Ø 650	4.114 / 27,2	6.489 / 41,3	3.825 / 27,2	6.029 / 41,3	4.309 / 27,2	6.770 / 41,3	5.534 / 35,2	8.317 / 51,3	5.263 / 35,2	7.897 / 51,3	5.687 / 35,2	8.526 / 51,3	7,6
Ø 950	9.102 / 56,7	14.360 / 86,0	8.466 / 56,7	13.342 / 86,0	9.535 / 56,7	14.982 / 86,0	11.036 / 67,7	16.585 / 99,1	10.494 / 67,7	15.748 / 99,1	11.342 / 67,7	17.004 / 99,1	19,0

Alle Lumenangaben für 4000K, CRI>80, Gehäusefarbe weiß

All lumen values for 4000K, CRI>80, housing colour white

Toutes les données de lumens pour 4000K, CRI>80, couleur du boîtier blanc

SQUARE90

ANBAULEUCHTE | SURFACE MOUNTED LUMINAIRE | LUMINAIRE EN SAILLIE



Quadratische LED-Flächenleuchte zur Anbaumontage. Direktstrahlend oder direkt-indirektstrahlend. Gehäuse aus Aluminiumprofil, nahtlos verschweißt. Fertigung der Leuchte in vier Größen: 350, 450, 650 und 950 mm mit einer Gesamthöhe von 90 mm. Oberfläche pulverbeschichtet feinstruktur matt ähnlich RAL 9016 weiß, RAL 9006 silber oder RAL 9005 schwarz – auf Anfrage in RAL nach Wahl. Die durchdachte Konstruktion der Leuchte ermöglicht ein Design in zahlreichen Farbkombinationen – zwischen Gehäusefarbe und Dekorring kann beliebig kombiniert werden. Um der Leuchtenfamilie neben den Standardfarben einen dekorativen Touch zu verleihen, steht der Dekorring auch in den strukturierten Spezialoberflächen schlaggold, schlagsilber und schlagbronze zur Auswahl. Diffuser in PMMA wahlweise opal, mikroprismatisch inkl. Streufolie oder nur mikroprismatisch (office special) für eine reduzierte Leuchtdichte (UGR<19). Einfache Montage durch Einschieben des Leuchtengehäuses in den Baldachin. Der LED-Treiber ist im Leuchtengehäuse integriert – wahlweise als on/off oder DALI-Variante. Farbtemperaturen 2700K, 3000K, 4000K oder dynamisch Weiß (2700K–6500K) – Farbwiedergabe CRI>80 oder CRI>90 – Mac Adam ≤3. Weitere Steuerungsoptionen oder Lichtfarben auf Anfrage möglich. Außerdem ist die Integration vieler Komponenten, wie beispielsweise Notlicht oder Sensortechnologie, sowie eine Vielzahl weiterer Optionen möglich.

Square surface mounted LED luminaire. Direct beam or direct-indirect beam. Housing made of aluminium profile, seamlessly welded. Luminaire manufactured in four sizes: 350, 450, 650 and 950 mm with a total height of 90 mm. Surface powder coated fine structure matt similar to RAL 9016 white, RAL 9006 silver or RAL 9005 black - on request in RAL of choice. The sophisticated construction of the luminaire allows a design in numerous colour combinations - any combination of housing colour and decorative ring is possible. To give the luminaire family a decorative touch in addition to the standard colours, the decorative ring is also available in the structured special surfaces of beaten gold, beaten silver and beaten bronze. Diffuser in PMMA either opal, microprism incl. diffuser foil or only microprism (office special) for reduced luminance (UGR<19). Easy mounting by sliding the luminaire housing into the canopy. The LED driver is integrated in the luminaire housing - either as on/off or DALI version. Colour temperatures 2700K, 3000K, 4000K or dynamic white (2700K-6500K) - colour rendering CRI>80 or CRI>90 - Mac Adam ≤3. Further control options or light colours available on request. In addition, the integration of many components, such as emergency lighting or sensor technology, as well as a variety of other options is possible.

Luminaire carré LED en saillie. Éclairage direct ou direct-indirect. Boîtier en profilé d'aluminium, soudé sans soudure. Fabrication du luminaire en quatre dimensions : 350, 450, 650 et 950 mm avec une hauteur totale de 90 mm. Surface revêtue par poudre à structure fine mate similaire à RAL 9016 blanc, RAL 9006 argent ou RAL 9005 noir - sur demande en RAL au choix. La construction bien pensée du luminaire permet un design dans de nombreuses combinaisons de couleurs - il est possible de combiner à volonté entre la couleur du boîtier et l'anneau décoratif. Pour donner à la famille de luminaires une touche décorative en plus des couleurs standard, l'anneau décoratif est également disponible dans les surfaces spéciales structurées or choc, argent choc et bronze choc. Diffuseur en PMMA au choix opale, microprismatique y compris film diffusant ou uniquement microprismatique (office special) pour un éblouissement réduit (UGR<19). Montage facile en insérant le corps du luminaire dans le canopy. Le driver LED est intégré dans le boîtier du luminaire - au choix en version on/off ou DALI. Températures de couleur 2700K, 3000K, 4000K ou blanc dynamique (2700K-6500K) - Rendu des couleurs CRI>80 ou CRI>90 - Mac Adam ≤3. Autres options de commande ou couleurs de lumière possibles sur demande. En outre, l'intégration de nombreux composants, tels que l'éclairage de secours ou la technologie des capteurs, une multitude d'autres options sont possibles.

ÜBERSICHT | OVERVIEW | VUE D'ENSEMBLE

TECHNICAL DATA

2700K / 3000K / 4000K / 2700-6500K

CRI>80 / CRI>90

MacAdam ≤ 3

up to 175 lm/W

on-off / DALI

direct / direct + indirect

opal / microprism / office special (UGR <19)

L80 B10 50.000h



RAL colour of your choice



Integration of Multisensor



Integration of emergency light



Contact us for more options...

HOUSING COLOUR

schwarz | black | noir
RAL 9005



silber | silver | argent
RAL 9006



weiß | white | blanc
RAL 9016



DECORATION RING COLOUR

schwarz | black | noir
RAL 9005



schlaggold | beaten gold | or texturés



silber | silver | argent
RAL 9006



schlagsilber | beaten silver | argent texturés



weiß | white | blanc
RAL 9016



schlagbronze | beaten bronze | bronze texturés



ANBAULEUCHE „SQ90“
SURFACE MOUNTED LUMINAIRE “SQ90”
LUMINAIRE EN SAILLIE « SQUARE90 »

Bestellbeispiel | Example order | Exemple de commande
 350 mm, CRI>90, 4000K, direct, low output on/off, black, beaten gold, microprismmicroprism

SQ90A-359401-LOBGM

1 2 3 4 5 6 7 8

1 GRÖSSE
SIZE
TAILLE

350 x 350 mm	35
450 x 450 mm	45
650 x 650 mm	65
950 x 950 mm	95

2 FARBWIEDERGABE
COLOUR RENDERING
RENDU DES COULEURS

CRI>80	8
CRI>90	9

3 FARBTEMPERATUR
COLOUR TEMPERATURE
TEMPÉRATURE DE COULEUR

2700K (CRI>90 only)	27
3000K	30
4000K	40
2700-6500K (CRI>90 only)	DW

4 LICHTVERTEILUNG
LIGHT DISTRIBUTION
DISTRIBUTION DE LA LUMIÈRE

direct	1
direct + indirect	2

5 LEISTUNG & STEUERUNG
OUTPUT & CONTROL
SORTIE & CONTRÔLE

low output on/off	LO
low output DALI	LD
high output on/off	HO
high output DALI	HD
dynamic white DALI DT8	DW

6 GEHÄUSEFARBE
HOUSING COLOUR
COULEUR DU BOÎTIER

black RAL 9005	B
silver RAL 9006	S
white RAL 9016	W

7 DEKORRING FARBE
DECORATION RING COLOUR
BAGUE DÉCORATIVE COULEUR

black RAL 9005	B
silver RAL 9006	S
white RAL 9016	W
beaten gold	G
beaten silver	A
beaten bronze	C

8 DIFFUSOR
DIFFUSER
DIFFUSEUR

opal	O
microprism	M
office special	B

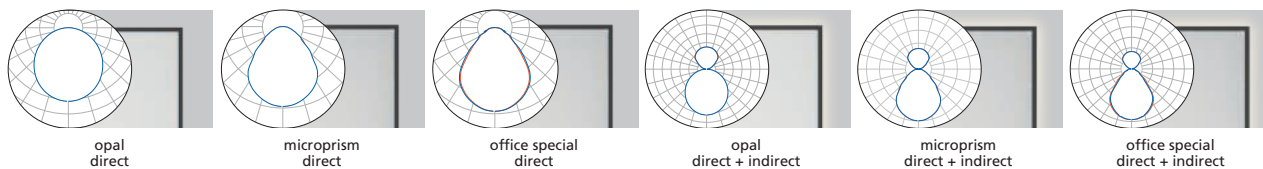
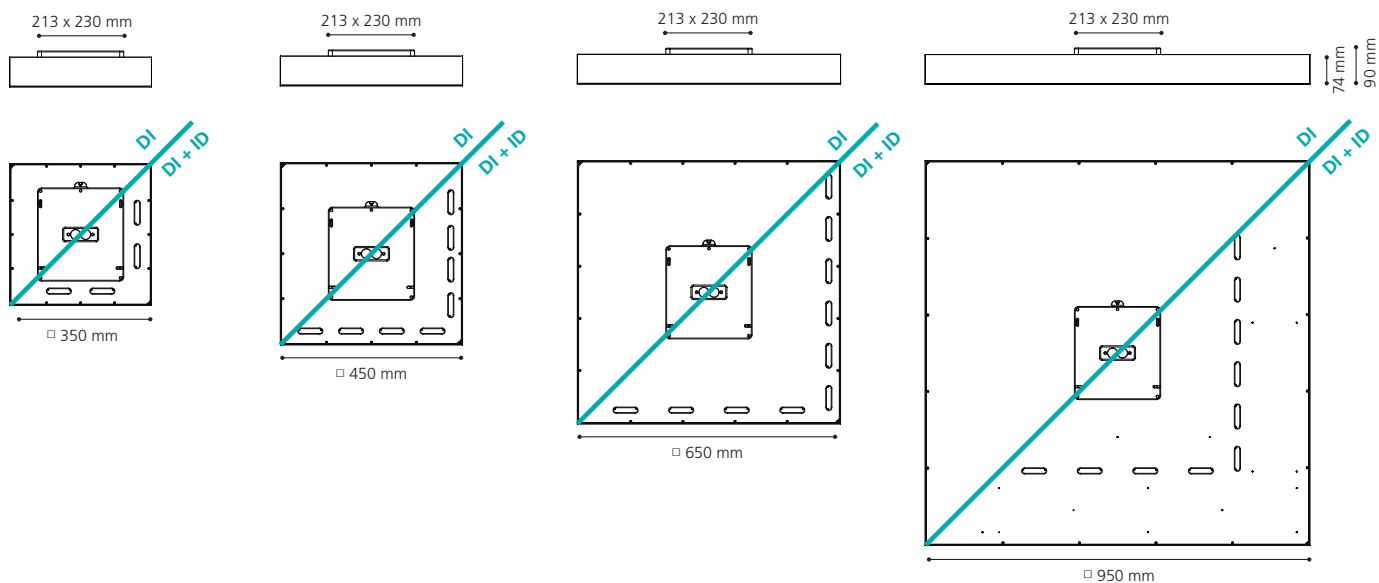

Size [mm]	opal direct		microprism direct		office special direct		opal direct + indirect		microprism direct + indirect		office special direct + indirect		kg
	low output [lm] / [W]	high output [lm] / [W]	low output [lm] / [W]	high output [lm] / [W]	low output [lm] / [W]	high output [lm] / [W]	low output [lm] / [W]	high output [lm] / [W]	low output [lm] / [W]	high output [lm] / [W]	low output [lm] / [W]	high output [lm] / [W]	
□ 350	1.349 / 9,9	2.365 / 16,7	1.256 / 9,9	2.208 / 16,7	1.402 / 9,9	2.470 / 16,7	2.029 / 13,8	3.488 / 23,1	1.923 / 13,8	3.308 / 23,1	2.081 / 13,8	3.579 / 23,1	3,9
□ 450	2.288 / 15,4	4.011 / 26,0	2.130 / 15,4	3.744 / 26,0	2.377 / 15,4	4.189 / 26,0	3.236 / 20,7	5.563 / 34,6	3.067 / 20,7	5.276 / 34,6	3.319 / 20,7	5.709 / 34,6	5,4
□ 650	4.711 / 30,5	8.258 / 51,6	4.385 / 30,5	7.708 / 51,6	4.894 / 30,5	8.624 / 51,6	5.845 / 37,0	10.048 / 61,8	5.845 / 37,0	9.530 / 61,8	5.995 / 37,0	10.312 / 61,8	9,3
□ 950	9.868 / 60,9	17.299 / 102,8	9.187 / 60,9	16.148 / 102,8	10.252 / 60,9	18.067 / 102,8	10.918 / 67,4	18.770 / 112,6	10.348 / 67,4	17.801 / 112,6	11.198 / 67,4	19.262 / 112,6	23,4

Aller Lumenangaben für 4000K, CRI>80, Gehäusefarbe weiß
 All lumen values for 4000K, CRI>80, housing colour white
 Toutes les données de lumens pour 4000K, CRI>80, couleur du boîtier blanc

techDOT150surface

DOWNLIGHT | DOWNLIGHT | DOWNLIGHT



Runder LED-Anbaudownlight direktstrahlend. Leuchte aus Aluminium-Druckguss mit einem Durchmesser von 151 mm und einer Höhe von 200 mm. Oberfläche der Leuchte feinstruktur matt pulverbeschichtet ähnlich RAL 9016 weiß oder ähnlich RAL 9005 schwarz. Das Baukastensystem ermöglicht das Auswählen von zwei unterschiedlichen Reflektor-Farben: silber-matt oder schwarz-matt für eine reduzierte Leuchtdichte (UGR<19). Der LED-Treiber ist im Leuchtgehäuse integriert – wahlweise als on/off Variante oder als DALI-Variante mit verschiedenen Leistungsstufen. Farbtemperaturen 3000K oder 4000K – Farbwiedergabe CRI>90 – Mac Adam ≤3. Weitere Optionen und Konfigurationen auf Anfrage möglich.

Round surface mounted LED downlight direct beam. Luminaire made of die-cast aluminium with a diameter of 151 mm and a height of 200 mm. Surface of the luminaire fine structure matt powder coated similar to RAL 9016 white or similar to RAL 9005 black. The modular system allows the selection of two different reflector colours: matt silver or matt black for reduced luminance (UGR<19). The LED driver is integrated in the luminaire housing - either as an on/off version or as a DALI version with different power levels. Colour temperatures 3000K or 4000K - colour rendering CRI>90 - Mac Adam ≤3. Further options and configurations available on request.

Luminaire rond LED en saillie à éclairage direct. Luminaire en aluminium moulé sous pression d'un diamètre de 151 mm et d'une hauteur de 200 mm. Surface du luminaire revêtue de poudre à structure fine mate similaire à RAL 9016 blanc ou similaire à RAL 9005 noir. Le système modulaire permet de choisir entre deux couleurs de réflecteur différentes : argent mat ou noir mat un éblouissement réduit (UGR<19). Le pilote LED est intégré dans le boîtier du luminaire - au choix en version on/off ou en version DALI avec différents niveaux de puissance. Températures de couleur 3000K ou 4000K - Rendu des couleurs CRI>90 - Mac Adam ≤3. Autres options et configurations possibles sur demande.

ÜBERSICHT | OVERVIEW | VUE D'ENSEMBLE

TECHNICAL DATA

3000K / 4000K

CRI>90

MacAdam ≤ 3

on-off / DALI

beam angle: 60°



230V AC



LED



>50,000h



3 SDCM



IP 20



CE



UK CA



Contact us for more options...

HOUSING COLOUR

schwarz | black | noir
RAL 9005



weiß | white | blanc
RAL 9016



REFLECTOR COLOUR

silber matt | silver matt | argenté mat



schwarz matt | black matt | noir mat



DOWNLIGHT „techDOT150surface“
 DOWNLIGHT “techDOT150surface”
 DOWNLIGHT « techDOT150surface »

Bestellbeispiel | Example order | Exemple de commande
 60°, CRI>90, 4000K, **direct**, low output on/off, black, silver matt

TD15A-609401-LOBLM

1 2 3 4

1	FARBTEMPERATUR	
	COLOUR TEMPERATURE TEMPÉRATURE DE COULEUR	
	3000K	30
	4000K	40
2	LEISTUNG & STEUERUNG	
	OUTPUT & CONTROL SORTIE & CONTRÔLE	
	low output on/off	LO
	high output on/off	HO
	high output DALI	HD

3	GEHÄUSEFARBE	
	HOUSING COLOUR COULEUR DU BOÎTIER	
	white RAL 9016	WH
	black RAL 9005	BL
4	REFLEKTOR FARBE	
	REFLECTOR COLOUR COULEUR DU RÉFLECTEUR	
	silver matt	M
	black matt	B

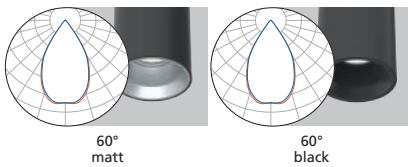
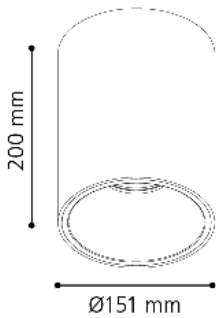

Size [mm]	low output [lm] / [W]	high output [lm] / [W]	low output [lm] / [W]	high output [lm] / [W]	 [kg]
Ø 151	1.333 / 15,5	2.135 / 25,0	1.277 / 15,5	2.085 / 25,0	2,2

Alle Lumenangaben für 4000K
 All lumen values for 4000K
 Toutes les données de lumens pour 4000K

OVERVIEW

HÄNGELEUCHTEN | PENDANT LUMINAIRES | SUSPENSIONS



LINE40
146



LINE50
148



LINE50hex
150



LINE50HEXmute
152



LINE50quad
154



LINE50QUADmute
156



LINE50splash
158



officeLINE50
160



officeLINE50
162



LINE70
164



RING50
166



RING50mute
168



FLEX50
170



OVOID50
172



ROUND90
174



SQUARE90
176



ROPE22
178

HÄNGELEUCHTEN

PENDANT LUMINAIRES

SUSPENSIONS

LINE40

HÄNGELEUCHE | PENDANT LUMINAIRE | LUMINAIRE SUSPENSION

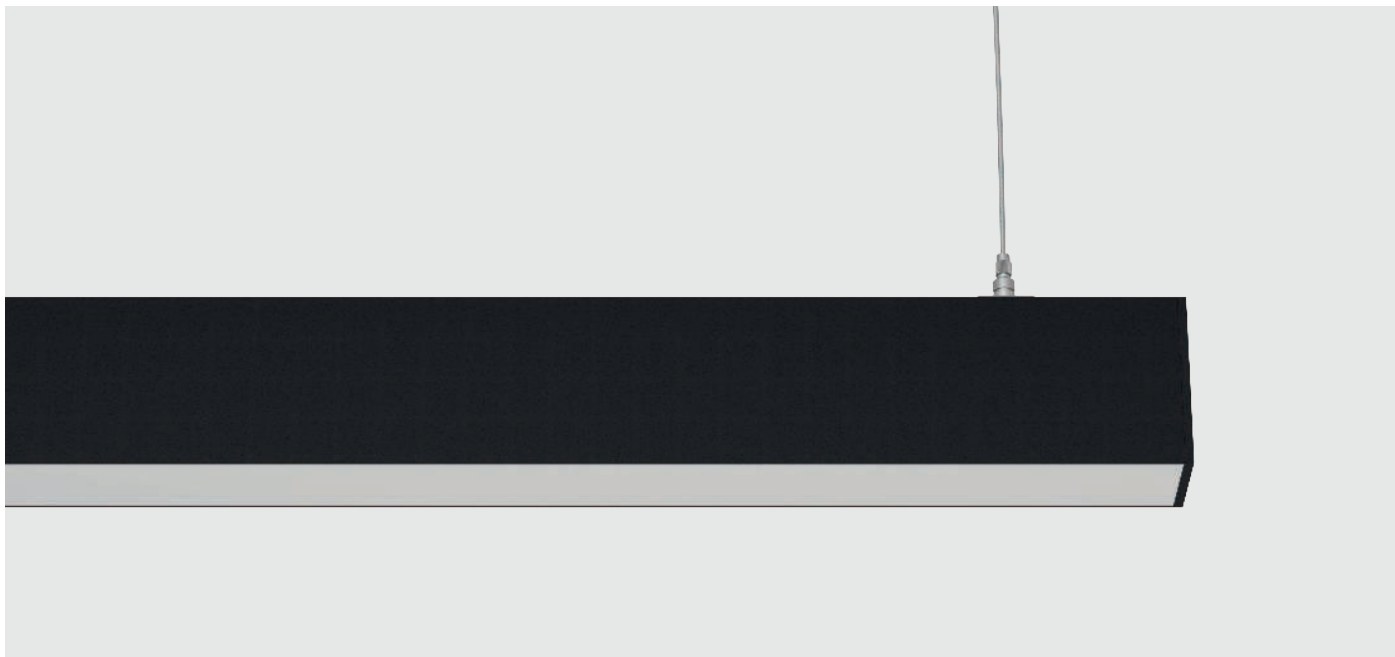

LED-Hängeleuchte direktstrahlend oder direkt-indirektstrahlend. Lichtkanal aus Aluminium-Strangpressprofil mit einer Breite von 41 mm. Fertigung der Leuchtenlänge millimetergenau auf Kundenwunsch möglich. Oberfläche der Leuchte feinstruktur matt pulverbeschichtet ähnlich RAL 9016 weiß, RAL 9006 silber oder RAL 9005 schwarz – auf Anfrage in RAL nach Wahl. Diffusor wahlweise in PMMA opal, PMMA opal U-Abdeckung oder PMMA klar mit eingeschobener mikroprismatischer Platte für eine reduzierte Leuchtdichte (UGR<19). Leuchte inkl. weißem, rechteckigem Baldachin mit transparentem Einspeisekabel sowie flexiblen Seilabhängern und Schnellspannern zur stufenlosen Regulierung der Montagehöhe. Der LED- Treiber ist im Leuchtengehäuse integriert – wahlweise als on/off oder DALI-Variante. Farbtemperaturen 2700K, 3000K, 4000K oder dynamisch Weiß (2700K-6500K) – Farbwiedergabe CRI>80 oder CRI>90 – Mac Adam ≤3. Weitere Steuerungsoptionen oder Lichtfarben auf Anfrage erhältlich. Außerdem ist die Integration vieler Komponenten, wie beispielsweise Notlicht oder Sensortechnologie, sowie eine Vielzahl weiterer Optionen möglich.

Pendant LED luminaire direct beam or direct-indirect beam. Light channel made of extruded aluminium profile with a width of 41 mm. Luminaire length can be manufactured to the exact millimetre on customer request. Surface of the luminaire fine structure matt powder coated similar to RAL 9016 white, RAL 9006 silver or RAL 9005 black - on request in RAL of choice. Diffuser either in PMMA opal, PMMA opal U-cover or PMMA clear with inserted microprismatic plate for reduced luminance (UGR<19). Luminaire incl. white, rectangular canopy with transparent feeding cable as well as flexible cord suspensions and quick-release clamps for continuous adjustment of mounting height. The LED driver is integrated in the luminaire housing - either as on/off or DALI version. Colour temperatures 2700K, 3000K, 4000K or dynamic white (2700K-6500K) - colour rendering CRI>80 or CRI>90 - Mac Adam ≤3. Further control options or light colours available on request. In addition, the integration of many components, such as emergency lighting or sensor technology, as well as a variety of other options is possible.

Suspension LED à éclairage direct ou direct-indirect. Canal lumineux en profilé d'aluminium extrudé d'une largeur de 41 mm. Fabrication de la longueur du luminaire au millimètre près possible sur demande du client. Surface du luminaire à structure fine, revêtement par poudre mat similaire à RAL 9016 blanc, RAL 9006 argent ou RAL 9005 noir - sur demande en RAL au choix. Diffuseur au choix en PMMA opale, PMMA opale cache U ou PMMA transparent avec plaque microprismatique insérée pour un éblouissement réduit (UGR<19). Luminaire avec rosace rectangulaire blanche, câble d'alimentation transparent, câble flexibles et tendeurs rapides permettant de régler la hauteur en continu. Le pilote LED est intégré dans le boîtier du luminaire - au choix sous forme de variante on/off ou DALI. Températures de couleur 2700K, 3000K, 4000K ou blanc dynamique (2700K-6500K) - Rendu des couleurs CRI>80 ou CRI>90 - Mac Adam ≤3. Autres options de commande ou couleurs de lumière disponibles sur demande. En outre, l'intégration de nombreux composants, tels que l'éclairage de secours ou des capteurs, une multitude d'autres options sont possibles.

ÜBERSICHT | OVERVIEW | VUE D'ENSEMBLE

TECHNICAL DATA

2700K / 3000K / 4000K / 2700-6500K

CRI>80 / CRI>90

MacAdam ≤ 3

up to 142 lm/W, up to 6.245 lm/m

on-off / DALI

direct / direct + indirect

opal / U-cover / microprism (UGR<19)

L80 B10 50.000h

HOUSING COLOUR

schwarz | black | noir
RAL 9005

silber | silver | argent
RAL 9006

weiß | white | blanc
RAL 9016



RAL colour of your choice



Integration of Multisensor



Welded mitre cuts



Integration of emergency light



Design Cables



Contact us for more options...

HÄNGELEUCHTE „LINE40“
 PENDANT LUMINAIRE “LINE40”
 LUMINAIRE SUSPENSION « LINE40 »

Bestellbeispiel | Example order | Exemple de commande
 3.132 mm, CRI>90, 4000K, direct + indirect, low output on/off, black, microprism

LI40H-319402-LOBLM

1 2 3 4 5 6 7

1 LÄNGE
 LENGTH
 LONGEUR

1.212 mm	12
1.452 mm	14
1.692 mm	16
1.932 mm	19
2.172 mm	21
2.412 mm	24
2.892 mm	28
3.132 mm	31
3.854 mm	38

2 FARBWIEDERGABE
 COLOUR RENDERING
 RENDU DES COULEURS

CRI>80	8
CRI>90	9

3 FARBTemperatur
 COLOUR TEMPERATURE
 TEMPÉRATURE DE COULEUR

2700K (CRI>90 only)	27
3000K	30
4000K	40
2700-6500K (CRI>90 only)	DW

4 LICHTVERTEILUNG
 LIGHT DISTRIBUTION
 DISTRIBUTION DE LA LUMIÈRE

direct	1
direct + indirect	2

5 LEISTUNG & STEUERUNG
 OUTPUT & CONTROL
 SORTIE & CONTRÔLE

low output on/off	LO
low output DALI	LD
high output on/off	HO
high output DALI	HD
dynamic white DALI DT8	DW

6 GEHÄUSEFARBE
 HOUSING COLOUR
 COULEUR DU BOÎTIER

silver RAL 9006	SI
white RAL 9016	WH
black RAL 9005	BL

7 DIFFUSOR
 DIFFUSER
 DIFFUSEUR

opal	O
microprism	M
U-cover (direct only)	U

direct

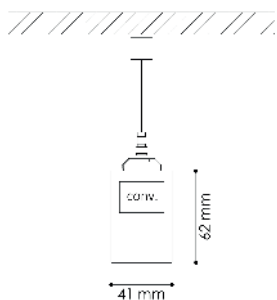

direct U-cover

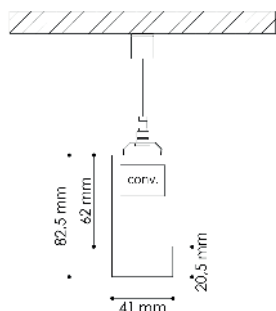

direct + indirect

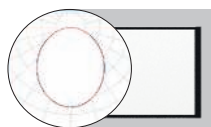
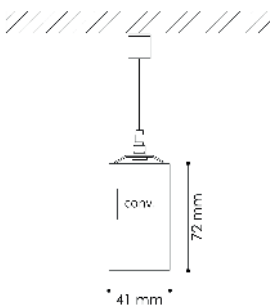

opal direct

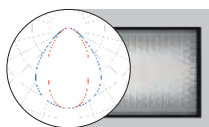

microprism direct

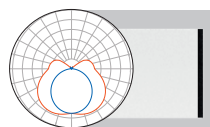

U-cover direct

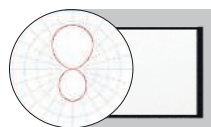

opal direct + indirect

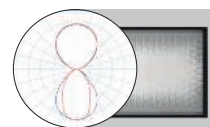

microprism direct + indirect

Size [mm]	direct		direct + indirect		direct		direct + indirect		direct	direct + indirect		
	low output [lm] / [W]	high output [lm] / [W]	low output [lm] / [W]	high output [lm] / [W]	low output [lm] / [W]	high output [lm] / [W]	low output [lm] / [W]	high output [lm] / [W]				
1.212	1.777 / 16,3	3.150 / 30,0	1.854 / 16,3	3.286 / 30,0	1.828 / 16,3	3.241 / 30,0	3.845 / 29,1	7.336 / 57,2	3.924 / 29,1	7.522 / 57,2	2,6	3,4
1.452	2.010 / 18,5	3.763 / 35,8	2.097 / 18,5	3.925 / 35,8	2.068 / 18,5	3.871 / 35,8	4.615 / 34,5	8.803 / 68,1	4.709 / 34,5	9.026 / 68,1	3,2	4,2
1.692	2.398 / 21,2	4.470 / 41,1	2.501 / 21,2	4.663 / 41,1	2.467 / 21,2	4.599 / 41,1	5.384 / 39,5	10.270 / 80,8	5.494 / 39,5	10.531 / 80,8	3,7	4,8
1.932	2.779 / 23,7	5.222 / 46,3	2.889 / 23,7	5.448 / 46,3	2.859 / 23,7	5.373 / 46,3	6.154 / 44,6	11.738 / 91,7	6.278 / 44,6	12.035 / 91,7	4,2	5,5
2.172	3.157 / 26,6	5.931 / 52,0	3.293 / 26,6	6.187 / 52,0	3.248 / 26,6	6.102 / 52,0	6.923 / 50,0	13.205 / 103,0	7.063 / 50,0	13.540 / 103,0	4,7	6,1
2.412	3.441 / 29,2	6.544 / 57,3	3.590 / 29,2	6.826 / 57,3	3.541 / 29,2	6.732 / 57,3	7.690 / 56,0	14.672 / 113,0	7.848 / 56,0	15.044 / 113,0	5,3	6,8
2.892	3.880 / 34,3	7.570 / 69,6	4.048 / 34,3	7.897 / 69,6	3.992 / 34,3	7.788 / 69,6	9.230 / 67,0	17.606 / 135,0	9.418 / 67,0	18.053 / 135,0	6,4	8,2
3.132	4.326 / 36,9	8.516 / 75,5	4.513 / 36,9	8.884 / 75,5	4.451 / 36,9	8.761 / 75,5	9.999 / 72,3	19.074 / 145,3	10.202 / 72,3	19.557 / 145,3	6,8	8,9
3.854	5.558 / 47,4	10.444 / 92,6	5.798 / 47,4	10.896 / 92,6	5.718 / 47,4	10.746 / 92,6	12.308 / 89,2	23.476 / 183,4	12.556 / 89,2	24.070 / 183,4	8,5	11,1

Alle Lumenangaben für 4000K, CRI>80, Microprisma ohne Opalfolie

All lumen values for 4000K, CRI>80, microprism without opal foil

Toutes les données de lumens pour 4000K, CRI>80, microprisme sans feuille opale

LINE50

HÄNGELEUCHE | PENDANT LUMINAIRE | LUMINAIRE SUSPENSION

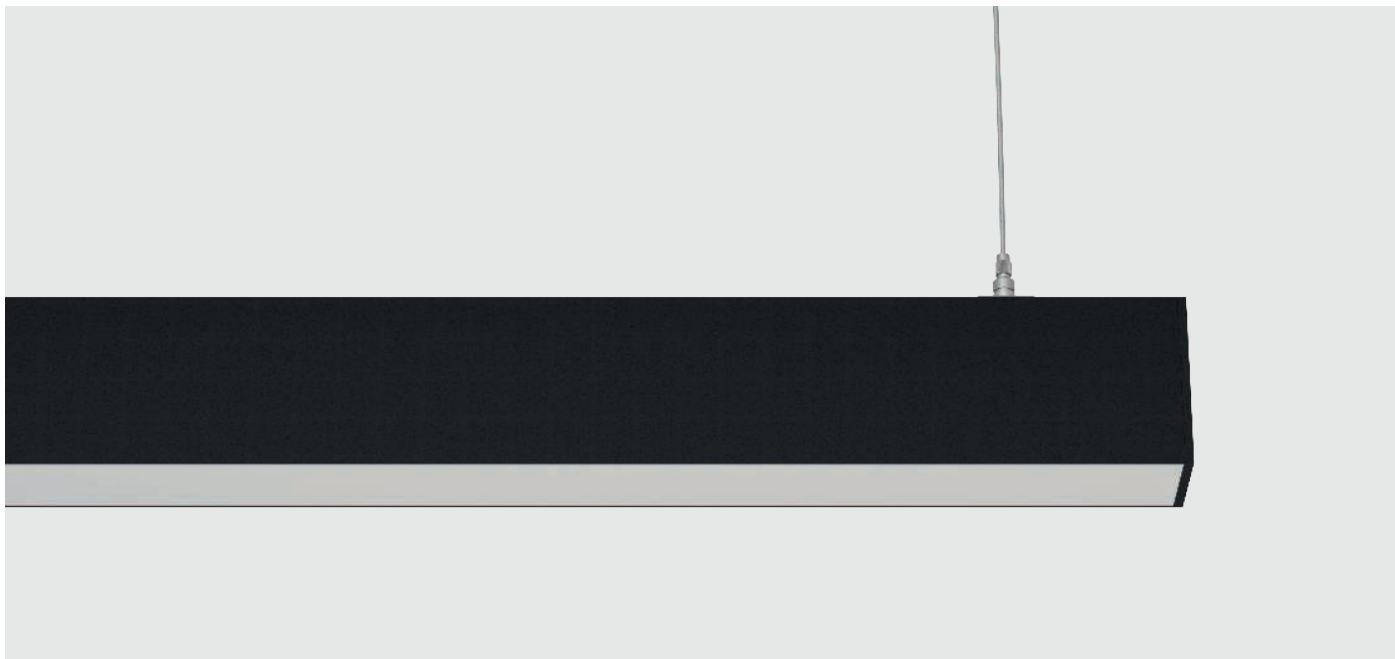

LED-Hängeleuchte direktstrahlend oder direkt-indirektstrahlend. Lichtkanal aus Aluminium-Strangpressprofil mit einer Breite von 50 mm. Fertigung der Leuchtenlänge millimetergenau auf Kundenwunsch möglich. Oberfläche der Leuchte feinstrukturiert matt pulverbeschichtet ähnlich RAL 9016 weiß, RAL 9006 silber oder RAL 9005 schwarz – auf Anfrage in RAL nach Wahl. Diffusor wahlweise in PMMA opal, PMMA klar mit eingeschobener asymmetrischer Folie oder PMMA klar mit eingeschobener mikroprismatischer Platte für eine reduzierte Leuchtdichte (UGR<19). Leuchte inkl. weißem, rechteckigem Baldachin mit transparentem Einspeisekabel sowie flexiblen Seilabhängern und Schnellspannern zur stufenlosen Regulierung der Montagehöhe. Der LED-Treiber ist im Leuchtgehäuse integriert – wahlweise als on/off oder DALI-Variante – Farbtemperaturen 2700K, 3000K, 4000K oder dynamisch Weiß (2700K–6500K) – Farbwiedergabe CRI>80 oder CRI>90 – Mac Adam ≤3. Weitere Steuerungsoptionen oder Lichtfarben auf Anfrage erhältlich. Außerdem ist die Integration vieler Komponenten, wie beispielsweise Notlicht oder Sensortechnologie, sowie eine Vielzahl weiterer Optionen möglich.

Pendant LED luminaire direct beam or direct-indirect beam. Light channel made of extruded aluminium profile with a width of 50 mm. Luminaire length can be manufactured to the exact millimetre on customer request. Surface of the luminaire fine structure matt powder coated similar to RAL 9016 white, RAL 9006 silver or RAL 9005 black - on request in RAL of choice. Diffuser either in PMMA opal, PMMA clear with inserted asymmetric foil or PMMA clear with inserted microprismatic plate for reduced luminance (UGR<19). Luminaire incl. white, rectangular canopy with transparent feeding cable as well as flexible cord suspensions and quick-release clamps for continuous adjustment of mounting height. The LED driver is integrated in the luminaire housing - either as on/off or DALI version - colour temperatures 2700K, 3000K, 4000K or dynamic white (2700K-6500K) - colour rendering CRI>80 or CRI>90 - Mac Adam ≤3. Further control options or light colours available on request. In addition, the integration of many components, such as emergency lighting or sensor technology, as well as a variety of other options is possible.

Suspension LED à éclairage direct ou direct-indirect. Canal lumineux en profilé d'aluminium extrudé d'une largeur de 50 mm. Fabrication de la longueur du luminaire au millimètre près possible sur demande du client. Surface du luminaire à structure fine, revêtement par poudre mat similaire à RAL 9016 blanc, RAL 9006 argent ou RAL 9005 noir - sur demande en RAL au choix. Diffuseur au choix en PMMA opale, PMMA transparent avec feuille asymétrique insérée ou PMMA transparent avec plaque microprismatique insérée pour un éblouissement réduit (UGR<19). Luminaire comprenant un abat-jour rectangulaire blanc avec câble d'alimentation transparent ainsi que des câbles flexibles et des tenisseurs rapides permettant de régler la hauteur de montage en continu. Le pilote LED est intégré dans le boîtier du luminaire - au choix sous forme de variante on/off ou DALI - températures de couleur 2700K, 3000K, 4000K ou blanc dynamique (2700K-6500K) - rendu des couleurs CRI>80 ou CRI>90 - Mac Adam ≤3. Autres options de commande ou couleurs de lumière disponibles sur demande. En outre, l'intégration de nombreux composants, tels que l'éclairage de secours ou la technologie de détection, une multitude d'autres options sont possibles.

ÜBERSICHT | OVERVIEW | VUE D'ENSEMBLE

TECHNICAL DATA

2700K / 3000K / 4000K / 2700-6500K

CRI>80 / CRI>90

MacAdam ≤ 3

up to 149 lm/W, up to 6.554 lm/m

on-off / DALI

direct / direct + indirect

opal / microprism (UGR <19) / asymmetric

L80 B10 50.000h

HOUSING COLOUR

schwarz | black | noir
RAL 9005

silber | silver | argent
RAL 9006

weiß | white | blanc
RAL 9016



RAL colour of your choice



Integration of 3-phase-track



Integration of Multisensor



Welded mitre cuts



Integration of emergency light



Integration of GLOWmini/
GLOWsmall series



Design Cables



Contact us for more options...

HÄNGELEUCHTE „LINE50“
 PENDANT LUMINAIRE “LINE50”
 LUMINAIRE SUSPENSION « LINE50 »

Bestellbeispiel | Example order | Exemple de commande
 3.134 mm, CRI>90, 4000K, direct + indirect, low output on/off, black, microprism

LI50H-319402-LOBLM

1 2 3 4 5 6 7

1 LÄNGE LENGTH LONGEUR	
1.214 mm	12
1.454 mm	14
1.694 mm	16
1.934 mm	19
2.174 mm	21
2.414 mm	24
2.894 mm	28
3.134 mm	31
3.856 mm	38

2 FARBWIEDERGABE COLOUR RENDERING RENDU DES COULEURS	
CRI>80	8
CRI>90	9

3 FARBTemperatur COLOUR TEMPERATURE TEMPÉRATURE DE COULEUR	
2700K (CRI>90 only)	27
3000K	30
4000K	40
2700-6500K (CRI>90 only)	DW

4 LICHTVERTEILUNG LIGHT DISTRIBUTION DISTRIBUTION DE LA LUMIÈRE	
direct	1
direct + indirect	2

5 LEISTUNG & STEUERUNG OUTPUT & CONTROL SORTIE & CONTRÔLE	
low output on/off	LO
low output DALI	LD
high output on/off	HO
high output DALI	HD
dynamic white DALI DT8	DW

6 GEHÄUSEFARBE HOUSING COLOUR COULEUR DU BOÎTIER	
silver RAL 9006	SI
white RAL 9016	WH
black RAL 9005	BL

7 DIFFUSOR DIFFUSER DIFFUSEUR	
opal	O
microprism	M
asymmetric	A

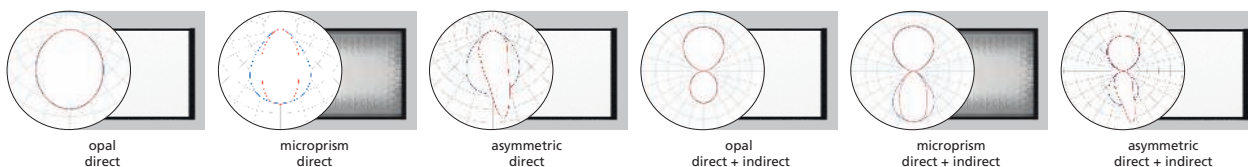
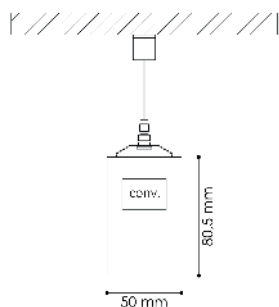

Size [mm]	opal direct		microprism direct		asymmetric direct		opal direct + indirect		microprism direct + indirect		asymmetric direct + indirect		direct	direct+ indirect
	low output [lm] / [W]	high output [lm] / [W]	low output [lm] / [W]	high output [lm] / [W]	low output [lm] / [W]	high output [lm] / [W]	low output [lm] / [W]	high output [lm] / [W]	low output [lm] / [W]	high output [lm] / [W]	low output [lm] / [W]	high output [lm] / [W]	kg	kg
1.214	1.818 / 16,3	3.463 / 30,0	1.652 / 16,3	3.162 / 30,0	1.850 / 16,3	3.541 / 30,0	4.120 / 29,1	7.898 / 57,0	3.845 / 29,1	7.336 / 57,2	4.076 / 29,1	7.776 / 57,2	2,9	3,6
1.454	2.182 / 18,5	4.156 / 35,8	1.982 / 18,5	3.794 / 35,8	2.220 / 18,5	4.249 / 35,8	4.944 / 34,5	9.477 / 68,0	4.615 / 34,5	8.803 / 68,1	4.892 / 34,5	9.331 / 68,1	3,5	4,4
1.694	2.546 / 21,2	4.848 / 41,1	2.313 / 21,2	4.427 / 41,1	2.591 / 21,2	4.958 / 41,1	5.769 / 39,5	11.057 / 81,0	5.384 / 39,5	10.270 / 80,8	5.707 / 39,5	10.886 / 80,8	4,1	5,1
1.934	2.911 / 23,7	5.541 / 46,3	2.642 / 23,7	5.059 / 46,3	2.959 / 23,7	5.666 / 46,3	6.592 / 44,6	12.636 / 92,0	6.154 / 44,6	11.738 / 91,7	6.523 / 44,6	12.442 / 91,7	4,6	5,8
2.174	3.273 / 26,6	6.233 / 52,0	2.974 / 26,6	5.692 / 52,0	3.331 / 26,6	6.375 / 52,0	7.416 / 49,9	14.217 / 103,0	6.923 / 49,9	13.205 / 103,0	7.338 / 49,9	13.997 / 103,0	5,2	6,5
2.414	3.635 / 29,2	6.926 / 57,3	3.304 / 29,2	6.324 / 57,3	3.700 / 29,2	7.083 / 57,3	8.240 / 56,0	15.796 / 113,0	7.690 / 56,0	14.672 / 113,1	8.151 / 56,0	15.552 / 113,1	5,8	7,2
2.894	4.364 / 34,3	8.311 / 69,6	3.964 / 34,3	7.589 / 69,6	4.440 / 34,3	8.500 / 69,6	9.889 / 67,0	18.955 / 135,0	9.230 / 67,0	17.606 / 134,8	9.784 / 67,0	18.662 / 134,8	7,0	8,7
3.134	4.728 / 36,9	9.004 / 75,5	4.295 / 36,9	8.221 / 75,5	4.810 / 36,9	9.208 / 75,5	10.712 / 72,3	20.534 / 145,0	9.999 / 72,3	19.074 / 145,3	10.599 / 72,3	20.218 / 145,3	7,5	9,4
3.856	5.821 / 47,4	11.082 / 92,6	5.284 / 47,4	10.118 / 92,6	5.918 / 47,4	11.332 / 92,6	13.183 / 89,2	25.273 / 183,0	12.308 / 89,2	23.476 / 183,4	13.046 / 89,2	24.885 / 183,4	9,3	11,7

Alle Lumenangaben für 4000K, CRI>80, Microprisma ohne Opalfolie
 All lumen values for 4000K, CRI>80, microprism without opal foil
 Toutes les données de lumens pour 4000K, CRI>80, microprisme sans feuille opale

LINE50hex

HÄNGELEUCHE | PENDANT LUMINAIRE | LUMINAIRE SUSPENSION

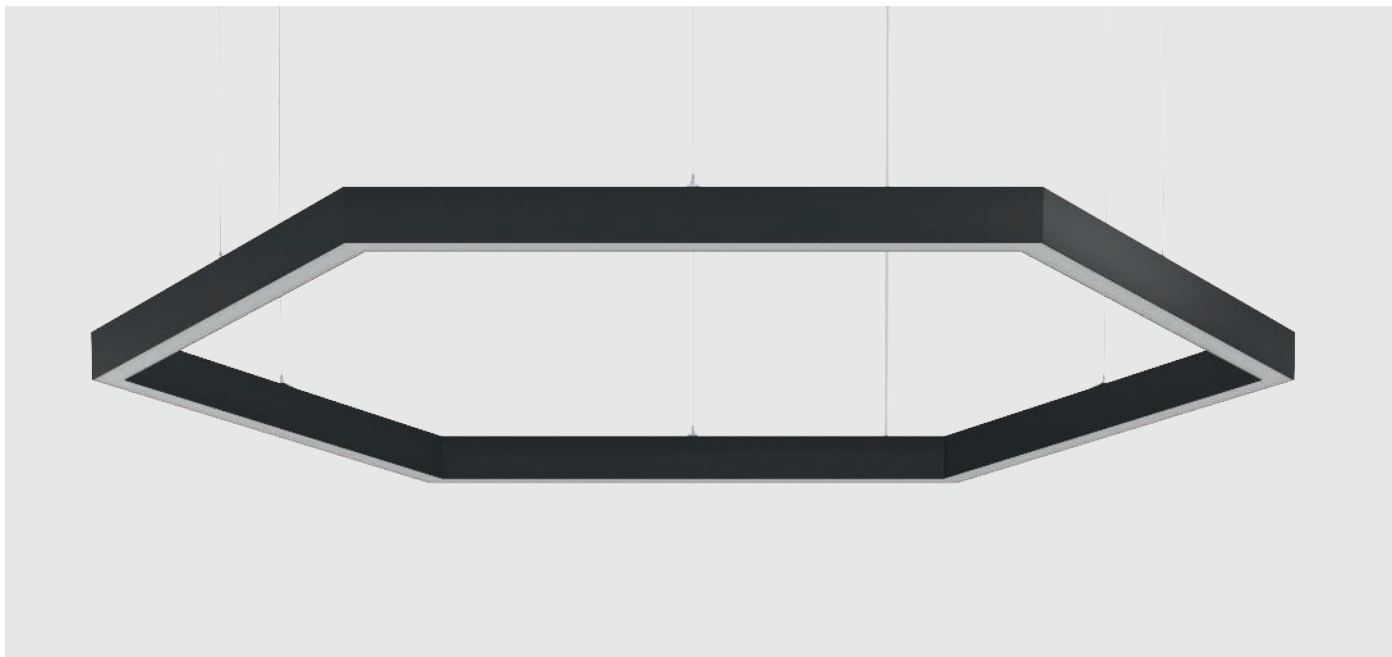

LED-Hängeleuchte direktstrahlend oder direkt-indirektstrahlend. Lichtkanal aus Aluminium-Strangpressprofil mit einer Breite von 50 mm. Leuchte in hexagonaler Form mit verschweißten Ecken – Lieferung der drei Standardgrößen komplett in einem Stück (DM 1306 mm), in zwei Teilen (DM 2028 mm) bzw. sechs gleich großen Teilen (DM 2988 mm). Oberfläche der Leuchte feinstruktur matt pulverbeschichtet ähnlich RAL 9016 weiß, RAL 9006 silber oder RAL 9005 schwarz – auf Anfrage in RAL nach Wahl. Diffusor wahlweise in PMMA opal oder PMMA klar mit eingeschobener mikroprismatischer Platte für eine reduzierte Leuchtdichte (UGR<19). Leuchte inkl. weißem, rechteckigem Baldachin mit transparentem Einspeisekabel sowie flexiblen Seilabhängern und Schnellspannern zur stufenlosen Regulierung der Montagehöhe. Der LED-Treiber ist im Leuchtengehäuse integriert – wahlweise als on/off oder DALI-Variante. Farbtemperaturen 2700K, 3000K, 4000K oder dynamisch Weiß (2700K–6500K) – Farbwiedergabe CRI>80 oder CRI>90 – Mac Adam ≤3. Weitere Steuerungsoptionen oder Lichtfarben auf Anfrage erhältlich. Außerdem ist die Integration vieler Komponenten, wie beispielsweise Notlicht oder Sensortechnologie, sowie eine Vielzahl weiterer Optionen möglich.

Pendant LED luminaire direct beam or direct-indirect beam. Light channel made of extruded aluminium profile with a width of 50 mm. Luminaire in hexagonal form with welded corners - delivery of the three standard sizes in one piece (DM 1306 mm), in two pieces (DM 2028 mm) or six equally sized pieces (DM 2988 mm). Surface of the luminaire fine structure matt powder coated similar to RAL 9016 white, RAL 9006 silver or RAL 9005 black - on request in RAL of choice. Diffuser either in PMMA opal or PMMA clear with inserted microprismatic plate for reduced luminance (UGR<19). Luminaire incl. white, rectangular canopy with transparent feeding cable as well as flexible cord suspensions and quick-release clamps for continuous adjustment of mounting height. The LED driver is integrated in the luminaire housing - either as on/off or DALI version. Colour temperatures 2700K, 3000K, 4000K or dynamic white (2700K-6500K) - colour rendering CRI>80 or CRI>90 - Mac Adam ≤3. Further control options or light colours available on request. In addition, the integration of many components, such as emergency lighting or sensor technology, as well as a variety of other options is possible.

Suspension LED à éclairage direct ou direct-indirect. Canal lumineux en profilé d'aluminium extrudé d'une largeur de 50 mm. Luminaire de forme hexagonale avec coins soudés - livraison des trois tailles standard complètes en une pièce (DM 1306 mm), en deux pièces (DM 2028 mm) ou en six pièces de taille identique (DM 2988 mm). Surface du luminaire à structure fine matte revêtue par poudre similaire à RAL 9016 blanc, RAL 9006 argent ou RAL 9005 noir - sur demande en RAL au choix. Diffuseur au choix en PMMA opale ou en PMMA transparent avec plaque microprismatique insérée pour un éblouissement réduit (UGR<19). Luminaire rectangulaire blanc avec câble d'alimentation transparent ainsi que des câbles flexibles et des tendeurs rapides permettant de régler la hauteur de montage en continu. Le pilote LED est intégré dans le boîtier du luminaire - au choix sous forme de variante on/off ou DALI. Températures de couleur 2700K, 3000K, 4000K ou blanc dynamique (2700K-6500K) - Rendu des couleurs CRI>80 ou CRI>90 - Mac Adam ≤3. Autres options de commande ou couleurs de lumière disponibles sur demande. En outre, l'intégration de nombreux composants, tels que l'éclairage de secours ou la technologie des capteurs, une multitude d'autres options sont possibles.

ÜBERSICHT | OVERVIEW | VUE D'ENSEMBLE

TECHNICAL DATA

2700K / 3000K / 4000K / 2700-6500K

CRI>80 / CRI>90

MacAdam ≤ 3

up to 141 lm/W, up to 6.268 lm/m

on-off / DALI

direct / direct + indirect

opal / microprism (UGR <19)

L80 B10 50.000h

HOUSING COLOUR

schwarz | black | noir
RAL 9005

silber | silver | argent
RAL 9006

weiß | white | blanc
RAL 9016



RAL colour of your choice



Integration of 3-phase-track



Integration of Multisensor



Welded mitre cuts



Integration of emergency light



Integration of GLOWmini/ GLOWsmall series



Design Cables



Contact us for more options...

HÄNGELEUCHTE „LINE50hex“
 PENDANT LUMINAIRE “LINE50hex”
 LUMINAIRE SUSPENSION « LINE50hex »

Bestellbeispiel | Example order | Exemple de commande
 2.988 mm, CRI>90, 4000K, direct + indirect, low output on/off, black, microprism

LH50H-299402-LOBLM

1 2 3 4 5 6 7

1 GRÖSSE
 SIZE
 TAILLE

1.306 mm	13
2.028 mm	20
2.988 mm	29

2 FARBWIEDERGABE
 COLOUR RENDERING
 RENDU DES COULEURS

CRI>80	8
CRI>90	9

3 FARBTEMPERATUR
 COLOUR TEMPERATURE
 TEMPÉRATURE DE COULEUR

2700K (CRI>90 only)	27
3000K	30
4000K	40
2700-6500K (CRI>90 only)	DW

4 LICHTVERTEILUNG
 LIGHT DISTRIBUTION
 DISTRIBUTION DE LA LUMIÈRE

direct	1
direct + indirect	2

5 LEISTUNG & STEUERUNG
 OUTPUT & CONTROL
 SORTIE & CONTRÔLE

low output on/off	LO
low output DALI	LD
high output on/off	HO
high output DALI	HD
dynamic white DALI DT8	DW

6 GEHÄUSEFARBE
 HOUSING COLOUR
 COULEUR DU BOÎTIER

silver RAL 9006	SI
white RAL 9016	WH
black RAL 9005	BL

7 DIFFUSOR
 DIFFUSER
 DIFFUSEUR

opal	O
microprism	M

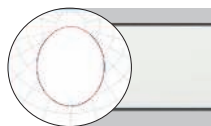
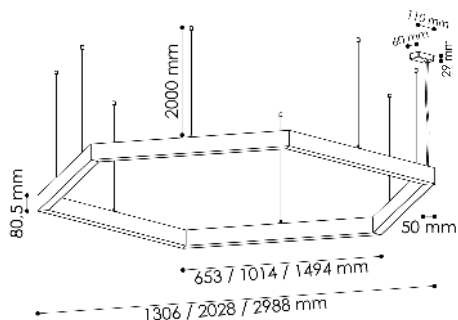

opal direct

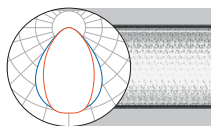

microprism direct

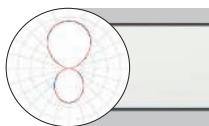

opal direct + indirect

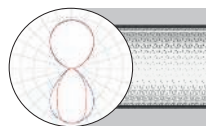

microprism direct + indirect

direct

direct + indirect

Size [mm]	opal direct		microprism direct		opal direct + indirect		microprism direct + indirect		direct	direct + indirect
	low output [lm] / [W]	high output [lm] / [W]	low output [lm] / [W]	high output [lm] / [W]	low output [lm] / [W]	high output [lm] / [W]	low output [lm] / [W]	high output [lm] / [W]	kg	kg
1.306	5.454 / 44,9	10.389 / 87,7	4.956 / 44,9	9.486 / 87,7	12.361 / 89,8	23.694 / 175,4	11.538 / 89,8	22.008 / 175,4	9,0	10,8
2.028	8.730 / 67,0	16.619 / 134,8	7.926 / 67,0	15.180 / 134,8	19.776 / 130,6	37.913 / 266,2	18.462 / 130,6	35.214 / 266,2	14,0	18,0
2.988	13.092 / 99,8	24.935 / 206,0	11.892 / 99,8	22.764 / 206,0	29.667 / 195,9	56.864 / 399,3	27.690 / 195,9	52.818 / 399,3	21,0	26,4

Alle Lumenangaben für 4000K, CRI>80, Microprisma ohne Opalfolie

All lumen values for 4000K, CRI>80, microprism without opal foil

Toutes les données de lumens pour 4000K, CRI>80, microprisme sans feuille opale

LINE50HEXmute

HÄNGELEUCHE | PENDANT LUMINAIRE | LUMINAIRE SUSPENSION



LED-Hängeleuchte direktstrahlend oder direkt-indirektstrahlend. Lichtkanal aus Aluminium-Strangpressprofil mit einer Breite von 50 mm. Leuchte in hexagonaler Form mit verschweißten Ecken – Lieferung komplett in einem Stück (DM 1306 mm). Oberfläche der Leuchte feinstruktur matt pulverbeschichtet ähnlich RAL 9016 weiß, RAL 9006 silber oder RAL 9005 schwarz – auf Anfrage in RAL nach Wahl. Akustik-elemente aus recyceltem PET in schwarz, hellgrau meliert, anthrazit meliert, burgunderrot oder olivgrün auswählbar. Diffusor wahlweise in PMMA opal oder PMMA klar mit eingeschobener mikroprismatischer Platte für eine reduzierte Leuchtdichte (UGR<19). Leuchte inkl. weißem, rechteckigem Baldachin mit transparentem Einspeisekabel sowie flexiblen Seilabhängern und Schnellspannern zur stufenlosen Regulierung der Montagehöhe. Der LED-Treiber ist im Leuchtgehäuse integriert – wahlweise als on/off oder DALI-Variante. Farbtemperaturen 2700K, 3000K, 4000K oder dynamisch Weiß (2700K–6500K) – Farbwiedergabe CRI>80 oder CRI>90 – Mac Adam ≤3.

Pendant LED luminaire direct beam or direct-indirect beam. Light channel made of extruded aluminium profile with a width of 50 mm. Luminaire in hexagonal form with welded corners - delivery in one piece (DM 1306 mm). Surface of the luminaire fine structure matt powder coated similar to RAL 9016 white, RAL 9006 silver or RAL 9005 black - on request in RAL of choice. Acoustic elements made of recycled PET available in black, light grey mottled, anthracite mottled, burgundy red or olive green. Diffuser either in PMMA opal or PMMA clear with inserted microprismatic plate for reduced luminance (UGR<19). Luminaire incl. white, rectangular canopy with transparent feeding cable as well as flexible cord suspensions and quick-release clamps for continuous adjustment of mounting height. The LED driver is integrated in the luminaire housing - either as on/off or DALI version. Colour temperatures 2700K, 3000K, 4000K or dynamic white (2700K-6500K) - colour rendering CRI>80 or CRI>90 - Mac Adam ≤3.

Suspension LED à éclairage direct ou direct-indirect. Canal lumineux en profilé d'aluminium extrudé d'une largeur de 50 mm. Luminaire de forme hexagonale avec coins soudés - livraison en une pièce (DM 1306 mm). Surface du luminaire à structure fine matte revêtue par poudre similaire à RAL 9016 blanc, RAL 9006 argent ou RAL 9005 noir - sur demande en RAL au choix. Éléments acoustiques fabriqués en PET recyclé en noir, gris clair chiné, anthracite chiné, rouge bordeaux ou vert olive au choix. Diffuseur au choix en PMMA opale ou en PMMA transparent avec plaque microprismatique insérée pour un éblouissement réduit (UGR<19). Luminaire rectangulaire blanc avec câble d'alimentation transparent ainsi que des câbles flexibles et des tendeurs rapides permettant de régler la hauteur de montage en continu. Le pilote LED est intégré dans le boîtier du luminaire - au choix sous forme de variante on/off ou DALI. Températures de couleur 2700K, 3000K, 4000K ou blanc dynamique (2700K-6500K) - Rendu des couleurs CRI>80 ou CRI>90 - Mac Adam ≤3.

ÜBERSICHT | OVERVIEW | VUE D'ENSEMBLE

TECHNICAL DATA
2700K / 3000K / 4000K / 2700-6500K
CRI>80 / CRI>90
MacAdam ≤ 3
up to 138 lm/W, up to 6268 lm/m
on-off / DALI
direct / direct + indirect
opal / microprism (UGR <19)
L80 B10 50.000h
acoustic material - fire classification: B-s2, d0 (EN13501-1:3018)

<p>RAL colour of your choice</p> <p>Contact us for more options...</p>							

HOUSING COLOUR	
schwarz black noir RAL 9005	
silber silver argent RAL 9006	
weiß white blanc RAL 9016	

COLOUR ACOUSTIC PANEL			
schwarz black noir		burgunderrot burgundy red rouge bourgogne	
hellgrau meliert light grey mottled gris clair chiné		olivgrün olive green vert olive	
anthrazit meliert anthracite mottled anthracite chiné			

HÄNGELEUCHTE „LINE50HEXmute“
 PENDANT LUMINAIRE “LINE50HEXmute”
 LUMINAIRE SUSPENSION « LINE50HEXmute »

Bestellbeispiel | Example order | Exemple de commande
 1.306 mm, CRI90, 4000K, direct + indirect, low output on/off, black, olive, microprism

LH5MH-139402-LOBOM

1 2 3 4 5 6 7

1 FARBWIEDERGABE
 COLOUR RENDERING
 RENDU DES COULEURS

CRI>80	8
CRI>90	9

2 FARBTEMPERATUR
 COLOUR TEMPERATURE
 TEMPÉRATURE DE COULEUR

2700K (CRI>90 only)	27
3000K	30
4000K	40
2700-6500K (CRI>90 only)	DW

3 LICHTVERTEILUNG
 LIGHT DISTRIBUTION
 DISTRIBUTION DE LA LUMIÈRE

direct	1
direct + indirect	2

4 LEISTUNG & STEUERUNG
 OUTPUT & CONTROL
 SORTIE & CONTRÔLE

low output on/off	LO
low output DALI	LD
high output on/off	HO
high output DALI	HD
dynamic white DALI DT8	DW

5 GEHÄUSEFARBE
 HOUSING COLOUR
 COULEUR DU BOÎTIER

silver RAL 9006	S
white RAL 9016	W
black RAL 9005	B

6 FARBE AKUSTIKPLATTE
 COLOUR ACOUSTIC PANEL
 COULEUR PANNEAU ACOUSTIQUE

black	B
light grey mottled	S
anthracite mottled	A
burgundy red	R
olive green	O

7 DIFFUSOR
 DIFFUSER
 DIFFUSEUR

opal	O
microprism	M

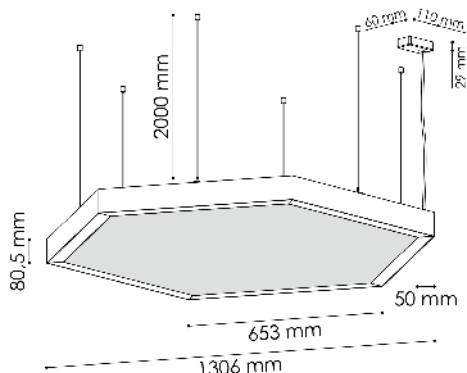

opal direct

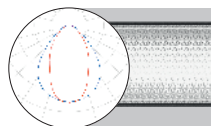

microprism direct

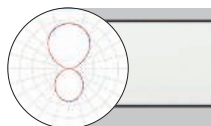

opal direct + indirect

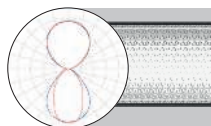

microprism direct + indirect

direct

direct + indirect

Size [mm]	low output [lm] / [W]		high output [lm] / [W]		low output [lm] / [W]		high output [lm] / [W]		direct [kg]	direct + indirect [kg]
	low output	high output	low output	high output	low output	high output	low output	high output		
1.306	5.454 / 44,9	10.389 / 87,7	4.956 / 44,9	9.486 / 87,7	12.361 / 89,8	23.694 / 175,4	11.538 / 89,8	22.008 / 175,4	12,9	14,6

Alle Lumenangaben für 4000K, CRI>80, Microprisma ohne Opalfolie
 All lumen values for 4000K, CRI>80, microprism without opal foil
 Toutes les données de lumens pour 4000K, CRI>80, microprisme sans feuille opale

LINE50quad

HÄNGELEUCHE | PENDANT LUMINAIRE | LUMINAIRE SUSPENSION



LED-Hängeleuchte direktstrahlend oder direkt-indirektstrahlend. Lichtkanal aus Aluminium-Strangpressprofil mit einer Breite von 50 mm. Leuchte in quadratischer Form mit verschweißten Ecken – Lieferung der drei Standardgrößen komplett in einem Stück (660, 1020 mm) bzw. in zwei Teilen (1500 mm). Oberfläche der Leuchte feinstruktur matt pulverbeschichtet ähnlich RAL 9016 weiß, RAL 9006 silber oder RAL 9005 schwarz – auf Anfrage in RAL nach Wahl. Diffusor wahlweise in PMMA opal oder PMMA klar mit eingeschobener mikroprismatischer Platte für eine reduzierte Leuchtdichte (UGR<19). Leuchte inkl. weißem, rechteckigem Baldachin mit transparentem Einspeisekabel sowie flexiblen Seilabhängern und Schnellspannern zur stufenlosen Regulierung der Montagehöhe. Der LED-Treiber ist im Leuchtegehäuse integriert – wahlweise als on/off oder DALI-Variante – Farbtemperaturen 2700K, 3000K, 4000K oder dynamisch Weiß (2700K–6500K) – Farbwiedergabe CRI>80 oder CRI>90 – Mac Adam ≤3. Weitere Steuerungsoptionen oder Lichtfarben auf Anfrage erhältlich. Außerdem ist die Integration vieler Komponenten, wie beispielsweise Notlicht oder Sensortechnologie, sowie eine Vielzahl weiterer Optionen möglich.

Pendant LED luminaire direct beam or direct-indirect beam. Light channel made of extruded aluminium profile with a width of 50 mm. Luminaire in square shape with welded corners - delivery of the three standard sizes in one piece (660, 1020 mm) or in two pieces (1500 mm). Surface of the luminaire fine structure matt powder coated similar to RAL 9016 white, RAL 9006 silver or RAL 9005 black - on request in RAL of choice. Diffuser either in PMMA opal or PMMA clear with inserted microprismatic plate for reduced luminance (UGR<19). Luminaire incl. white, rectangular canopy with transparent feeding cable as well as flexible wire suspensions and quick-release fasteners for stepless adjustment of mounting height. The LED driver is integrated in the luminaire housing - either as on/off or DALI version - colour temperatures 2700K, 3000K, 4000K or dynamic white (2700K-6500K) - colour rendering CRI>80 or CRI>90 - Mac Adam ≤3. Further control options or light colours available on request. In addition, the integration of many components, such as emergency lighting or sensor technology, as well as a variety of other options is possible.

Suspension LED à éclairage direct ou direct-indirect. Canal lumineux en profilé d'aluminium extrudé d'une largeur de 50 mm. Luminaire de forme carrée avec coins soudés - livraison des trois tailles standard complètes en une pièce (660, 1020 mm) ou en deux pièces (1500 mm). Surface du luminaire à structure entièrement en une seule pièce. Surface du luminaire à structure fine matte revêtue par poudre similaire à RAL 9016 blanc, RAL 9006 argent ou RAL 9005 noir - sur demande en RAL au choix. Diffuseur au choix en PMMA opale ou en PMMA transparent avec plaque microprismatique insérée pour un éblouissement réduit (UGR<19). Luminaire avec rosace rectangulaire blanche, câble d'alimentation transparent, de câbles flexibles et tendeurs rapides permettant de régler la hauteur de montage en continu. Le pilote LED est intégré dans le boîtier du luminaire - au choix sous forme de variante on/off ou DALI - températures de couleur 2700K, 3000K, 4000K ou blanc dynamique (2700K-6500K) - rendu des couleurs CRI>80 ou CRI>90 - Mac Adam ≤3. Autres options de commande ou couleurs de lumière disponibles sur demande. En outre, l'intégration de nombreux composants, tels que l'éclairage de secours ou la technologie des capteurs, une multitude d'autres options sont possibles.

ÜBERSICHT | OVERVIEW | VUE D'ENSEMBLE

TECHNICAL DATA

2700K / 3000K / 4000K / 2700-6500K

CRI>80 / CRI>90

MacAdam ≤ 3

up to 141 lm/W, up to 6.268 lm/m

on-off / DALI

direct / direct + indirect

opal / microprism (UGR <19)

L80 B10 50.000h

HOUSING COLOUR

schwarz | black | noir
RAL 9005

silber | silver | argent
RAL 9006

weiß | white | blanc
RAL 9016



RAL colour of your choice



Integration of 3-phase-track



Integration of Multisensor



Welded mitre cuts



Integration of emergency light



Integration of GLOWmini/
GLOWsmall series



Design Cables



Contact us for more options...

HÄNGELEUCHTE „LINE50quad“
 PENDANT LUMINAIRE “LINE50quad”
 LUMINAIRE SUSPENSION « LINE50quad »

Bestellbeispiel | Example order | Exemple de commande
 660 x 660 mm, CRI>90, 4000K, direct + indirect, low output on/off, black, microprism

LQ50H-069402-LOBLM

1 2 3 4 5 6 7

1	GRÖSSE SIZE TAILLE	
	660 x 660 mm	06
	1.020 x 1.020 mm	10
	1.500 x 1.500 mm	15
2	FARBWIEDERGABE COLOUR RENDERING RENDU DES COULEURS	
	CRI>80	8
	CRI>90	9
3	FARBTEMPERATUR COLOUR TEMPERATURE TEMPÉRATURE DE COULEUR	
	2700K (CRI>90 only)	27
	3000K	30
	4000K	40
	2700-6500K (CRI>90 only)	DW

4	LICHTVERTEILUNG LIGHT DISTRIBUTION DISTRIBUTION DE LA LUMIÈRE	
	direct	1
	direct + indirect	2
5	LEISTUNG & STEUERUNG OUTPUT & CONTROL SORTIE & CONTRÔLE	
	low output on/off	LO
	low output DALI	LD
	high output on/off	HO
	high output DALI	HD
	dynamic white DALI DT8	DW

6	GEHÄUSEFARBE HOUSING COLOUR COULEUR DU BOÎTIER	
	silver RAL 9006	SI
	white RAL 9016	WH
	black RAL 9005	BL
7	DIFFUSOR DIFFUSER DIFFUSEUR	
	opal	O
	microprism	M

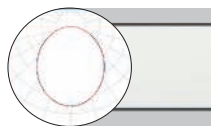
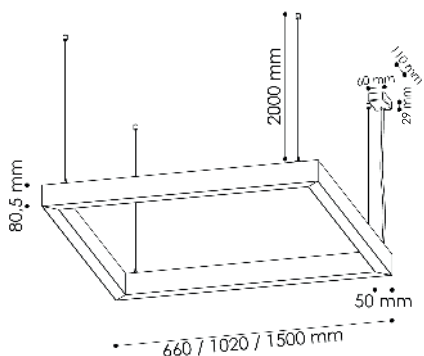

opal direct

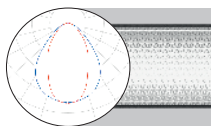

microprism direct

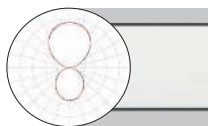

opal direct + indirect

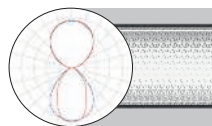

microprism direct + indirect

direct

direct + indirect

Size [mm]	opal direct		microprism direct		opal direct + indirect		microprism direct + indirect		direct KG	direct + indirect KG
	low output [lm] / [W]	high output [lm] / [W]	low output [lm] / [W]	high output [lm] / [W]	low output [lm] / [W]	high output [lm] / [W]	low output [lm] / [W]	high output [lm] / [W]		
□ 660	3.637 / 29,1	6.926 / 57,2	3.304 / 29,1	6.324 / 57,2	8.240 / 54,3	15.796 / 111,4	7.692 / 54,3	14.672 / 111,4	6,0	7,2
□ 1.020	5.821 / 44,6	11.080 / 91,7	5.284 / 44,6	10.120 / 91,7	13.184 / 85,8	25.276 / 180,0	12.308 / 85,8	23.476 / 180,0	9,2	12,0
□ 1.500	8.728 / 67,0	16.624 / 134,8	7.928 / 67,0	15.176 / 134,8	19.778 / 130,6	37.909 / 266,2	18.460 / 130,6	35.212 / 266,2	14,0	17,6

Alle Lumenangaben für 4000K, CRI>80, Microprisma ohne Opalfolie

All lumen values for 4000K, CRI>80, microprism without opal foil

Toutes les données de lumens pour 4000K, CRI>80, microprisme sans feuille opale

LINE50QUADmute

HÄNGELEUCHE | PENDANT LUMINAIRE | LUMINAIRE SUSPENSION



LED-Hängeleuchte direktstrahlend oder direkt-indirektstrahlend. Lichtkanal aus Aluminium-Strangpressprofil mit einer Breite von 50 mm. Leuchte in quadratischer Form mit verschweißten Ecken – Lieferung der zwei Standardgrößen komplett in einem Stück (660, 1020 mm). Oberfläche der Leuchte feinstruktur matt pulverbeschichtet ähnlich RAL 9016 weiß, RAL 9006 silber oder RAL 9005 schwarz – auf Anfrage in RAL nach Wahl. Akustikelemente aus recyceltem PET in schwarz, hellgrau meliert, anthrazit meliert, burgunderrot oder olivgrün auswählbar. Diffusor wahlweise in PMMA opal oder PMMA klar mit eingeschobener mikroprismatischer Platte für eine reduzierte Leuchtdichte (UGR<19). Leuchte inkl. weißem, rechteckigem Baldachin mit transparentem Einspeisekabel sowie flexiblen Seilabhängern und Schnellspannern zur stufenlosen Regulierung der Montagehöhe. Der LED-Treiber ist im Leuchtgehäuse integriert – wahlweise als on/off oder DALI-Variante – Farbtemperaturen 2700K, 3000K, 4000K oder dynamisch Weiß (2700K– 6500K) – Farbwiedergabe CRI>80 oder CRI>90 – Mac Adam ≤3.

Pendant LED luminaire direct beam or direct-indirect beam. Light channel made of extruded aluminium profile with a width of 50 mm. Luminaire in square shape with welded corners - delivery of the two standard sizes in one piece (660, 1020 mm). Surface of the luminaire fine structure matt powder coated similar to RAL 9016 white, RAL 9006 silver or RAL 9005 black - on request in RAL of choice. Acoustic elements made of recycled PET available in black, light grey mottled, anthracite mottled, burgundy red or olive green. Diffuser either in PMMA opal or PMMA clear with inserted microprismatic plate for reduced luminance (UGR<19). Luminaire incl. white, rectangular canopy with transparent feeding cable as well as flexible wire suspensions and quick-release fasteners for stepless adjustment of mounting height. The LED driver is integrated in the luminaire housing - either as on/off or DALI version - colour temperatures 2700K, 3000K, 4000K or dynamic white (2700K-6500K) - colour rendering CRI>80 or CRI>90 - Mac Adam ≤3.

Suspension LED à éclairage direct ou direct-indirect. Canal lumineux en profilé d'aluminium extrudé d'une largeur de 50 mm. Luminaire de forme carrée avec coins soudés - livraison des deux tailles standard complètes en une pièce (660, 1020 mm). Surface du luminaire à structure entièrement en une seule pièce. Surface du luminaire à structure fine matte revêtue par poudre similaire à RAL 9016 blanc, RAL 9006 argent ou RAL 9005 noir - sur demande en RAL au choix. Éléments acoustiques fabriqués en PET recycle en noir, gris clair chiné, anthracite chiné, rouge bordeaux ou vert olive au choix. Diffuseur au choix en PMMA opale ou en PMMA transparent avec plaque microprismatique insérée pour un éblouissement réduit (UGR<19). Luminaire avec rosace rectangulaire blanche, câble d'alimentation transparent, de câble flexibles et tendeurs rapides permettant de régler la hauteur de montage en continu. Le pilote LED est intégré dans le boîtier du luminaire - au choix sous forme de variante on/off ou DALI - températures de couleur 2700K, 3000K, 4000K ou blanc dynamique (2700K-6500K) - rendu des couleurs CRI>80 ou CRI>90 - Mac Adam ≤3.

ÜBERSICHT | OVERVIEW | VUE D'ENSEMBLE

TECHNICAL DATA
2700K / 3000K / 4000K / 2700-6500K
CRI>80 / CRI>90
MacAdam ≤ 3
up to 154 lm/W, up to 6268 lm/m
on-off / DALI
direct / direct + indirect
opal / microprism (UGR <19)
L80 B10 50.000h
acoustic material - fire classification: B-s2, d0 (EN13501-1:3018)

<p>RAL colour of your choice</p> <p>Contact us for more options...</p>							

HOUSING COLOUR	
schwarz black noir RAL 9005	
silber silver argent RAL 9006	
weiß white blanc RAL 9016	

COLOUR ACOUSTIC PANEL			
schwarz black noir		burgunderrot burgundy red rouge bourgogne	
hellgrau meliert light grey mottled gris clair chiné		olivgrün olive green vert olive	
anthrazit meliert anthracite mottled anthracite chiné			

HÄNGELEUCHTE „LINE50QUADmute“
 PENDANT LUMINAIRE “LINE50QUADmute”
 LUMINAIRE SUSPENSION « LINE50QUADmute »

Bestellbeispiel | Example order | Exemple de commande
 660 x 660 mm, CRI90, 4000K, direct + indirect, low output on/off, black, olive, microprism

LQ5MH-069402-LOBOM

1 2 3 4 5 6 7 8

1 GRÖSSE
 SIZE
 TAILLE

660 x 660 mm	06
1.020 x 1.020 mm	10

2 FARBWIEDERGABE
 COLOUR RENDERING
 RENDU DES COULEURS

CRI>80	8
CRI>90	9

3 FARBTEMPERATUR
 COLOUR TEMPERATURE
 TEMPÉRATURE DE COULEUR

2700K (CRI>90 only)	27
3000K	30
4000K	40
2700-6500K (CRI>90 only)	DW

4 LICHTVERTEILUNG
 LIGHT DISTRIBUTION
 DISTRIBUTION DE LA LUMIÈRE

direct	1
direct + indirect	2

5 LEISTUNG & STEUERUNG
 OUTPUT & CONTROL
 SORTIE & CONTRÔLE

low output on/off	LO
low output DALI	LD
high output on/off	HO
high output DALI	HD
dynamic white DALI DT8	DW

6 GEHÄUSEFARBE
 HOUSING COLOUR
 COULEUR DU BOÎTIER

silver RAL 9006	S
white RAL 9016	W
black RAL 9005	B

7 FARBE AKUSTIKPLATTE
 COLOUR ACOUSTIC PANEL
 COULEUR PANNEAU ACOUSTIQUE

black	B
light grey mottled	S
anthracite mottled	A
burgundy red	R
olive green	O

8 DIFFUSOR
 DIFFUSER
 DIFFUSEUR

opal	O
microprism	M

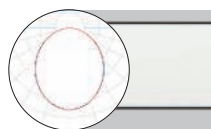
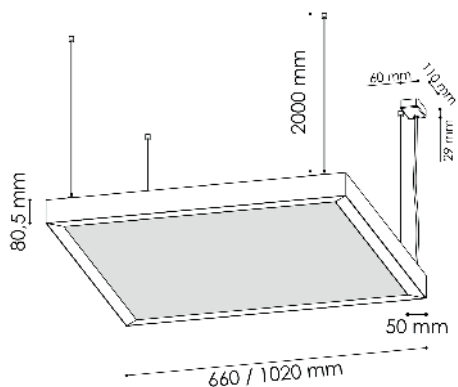

opal
direct

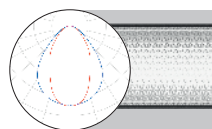

microprism
direct

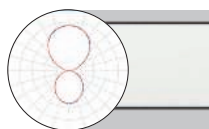

opal
direct + indirect

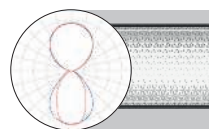

microprism
direct + indirect

direct
direct + indirect

Size [mm]	low output [lm] / [W]		high output [lm] / [W]		low output [lm] / [W]		high output [lm] / [W]		direct [kg]	direct + indirect [kg]
	low output [lm] / [W]	high output [lm] / [W]	low output [lm] / [W]	high output [lm] / [W]	low output [lm] / [W]	high output [lm] / [W]	low output [lm] / [W]	high output [lm] / [W]		
□ 660	3.637 / 29,1	6.926 / 57,2	3.304 / 29,1	6.324 / 57,2	8.240 / 54,3	15.796 / 111,4	7.692 / 54,3	14.672 / 111,4	7,3	8,5
□ 1.020	5.821 / 44,6	11.080 / 91,7	5.284 / 44,6	10.120 / 91,7	13.184 / 85,8	25.276 / 180,0	12.308 / 85,8	23.476 / 180,0	12,7	15,5

Alle Lumenangaben für 4000K, CRI>80, Microprisma ohne Opalfolie
 All lumen values for 4000K, CRI>80, microprism without opal foil
 toutes les données de lumens pour 4000K, CRI>80, microprisme sans feuille opale

LINE50splash

HÄNGELEUCHE | PENDANT LUMINAIRE | LUMINAIRE SUSPENSION



LED-Hängeleuchte mit erhöhter Schutzart IP54 direktstrahlend. Lichtkanal aus Aluminium-Strangpressprofil mit einer Breite von 50 mm. Oberfläche der Leuchte feinstruktur matt pulverbeschichtet ähnlich RAL 9016 weiß, RAL 9006 silber oder RAL 9005 schwarz – auf Anfrage in RAL nach Wahl. Diffusor wahlweise in PMMA opal, PMMA klar mit eingeschobener asymmetrischer Folie oder PMMA klar mit eingeschobener mikroprismatischer Platte für eine reduzierte Leuchtdichte (UGR<19). Leuchte inkl. transparentem Einspeisekabel sowie flexiblen Seilabhängern und Schnellspannern zur stufenlosen Regulierung der Montagehöhe. Der LED-Treiber ist im Leuchtgehäuse integriert – wahlweise als on/off oder DALI-Variante – Farbtemperaturen 2700K, 3000K, 4000K oder dynamisch Weiß (2700K–6500K) – Farbwiedergabe CRI>80 oder CRI>90 – Mac Adam ≤3. Weitere Steuerungsoptionen oder Lichtfarben auf Anfrage erhältlich. Außerdem ist die Integration vieler Komponenten, wie beispielsweise Notlicht, sowie eine Vielzahl weiterer Optionen möglich.

Pendant LED luminaire with increased protection rating IP54 and direct beam. Light channel made of extruded aluminium profile with a width of 50 mm. Surface of the luminaire fine structure matt powder coated similar to RAL 9016 white, RAL 9006 silver or RAL 9005 black - on request in RAL of choice. Diffuser either in PMMA opal, PMMA clear with inserted asymmetric foil or PMMA clear with inserted microprismatic plate for reduced luminance (UGR<19). Luminaire incl. transparent feeding cable as well as flexible cord suspensions and quickrelease clamps for continuous adjustment of mounting height. The LED driver is integrated in the luminaire housing - either as on/off or DALI version - colour temperatures 2700K, 3000K, 4000K or dynamic white (2700K-6500K) - colour rendering CRI>80 or CRI>90 - Mac Adam ≤3. Further control options or light colours available on request. In addition, the integration of many components, such as emergency lighting, as well as a variety of other options is possible.

Suspension LED avec un degré de protection élevé IP54 à éclairage direct. Canal lumineux en profilé d'aluminium extrudé d'une largeur de 50 mm. Surface du luminaire à structure fine, revêtement par poudre mat similaire à RAL 9016 blanc, RAL 9006 argent ou RAL 9005 noir - sur demande en RAL au choix. Diffuseur au choix en PMMA opale, PMMA transparent avec feuille asymétrique insérée ou PMMA transparent avec plaque microprismatique insérée pour un éblouissement réduit (UGR<19). Luminaire comprenant câble d'alimentation transparent ainsi que des câbles flexibles et des tendeurs rapides permettant de régler la hauteur de montage en continu. Le pilote LED est intégré dans le boîtier du luminaire - au choix sous forme de variante on/off ou DALI - températures de couleur 2700K, 3000K, 4000K ou blanc dynamique (2700K-6500K) - rendu des couleurs CRI>80 ou CRI>90 - Mac Adam ≤3. Autres options de commande ou couleurs de lumière disponibles sur demande. En outre, l'intégration de nombreux composants, tels que l'éclairage de secours, une multitude d'autres options sont possibles.

ÜBERSICHT | OVERVIEW | VUE D'ENSEMBLE

TECHNICAL DATA

2700K / 3000K / 4000K / 2700-6500K

CRI>80 / CRI>90

MacAdam ≤ 3

up to 130 lm/W, up to 2.930 lm/m

on-off / DALI

direct

opal / microprism (UGR <19) / asymmetric

L80 B10 50.000h

HOUSING COLOUR

schwarz | black | noir
RAL 9005

silber | silver | argent
RAL 9006

weiß | white | blanc
RAL 9016



RAL colour of your choice



Integration of emergency light



Contact us for more options...

HÄNGELEUCHTE „LINE50splash“
 PENDANT LUMINAIRE “LINE50splash”
 LUMINAIRE SUSPENSION « LINE50splash »

Bestellbeispiel | Example order | Exemple de commande
 3.145 mm, CRI90, 4000K, **direct**, low output on/off, black, microprism

LS50H-319401-LOBLM

1 2 3 4 5 6

1 LÄNGE
 LENGTH
 LONGEUR

1.225 mm	12
1.465 mm	14
1.705 mm	17
1.945 mm	19
2.185 mm	21
2.425 mm	24
2.905 mm	29
3.145 mm	31
3.867 mm	38

2 FARBWIEDERGABE
 COLOUR RENDERING
 RENDU DES COULEURS

CRI>80	8
CRI>90	9

3 FARBTEMPERATUR
 COLOUR TEMPERATURE
 TEMPÉRATURE DE COULEUR

2700K (CRI>90 only)	27
3000K	30
4000K	40
2700-6500K (CRI>90 only)	DW

4 LEISTUNG & STEUERUNG
 OUTPUT & CONTROL
 SORTIE & CONTRÔLE

low output on/off	LO
low output DALI	LD
high output on/off	HO
high output DALI	HD
dynamic white DALI DT8	DW

5 GEHÄUSEFARBE
 HOUSING COLOUR
 COULEUR DU BOÎTIER

silver RAL 9006	SI
white RAL 9016	WH
black RAL 9005	BL

6 DIFFUSOR
 DIFFUSER
 DIFFUSEUR

opal	O
microprism	M
asymmetric	A

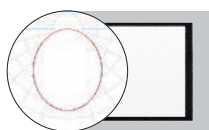
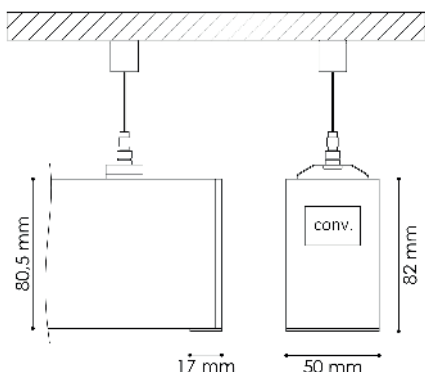

opal
 direct

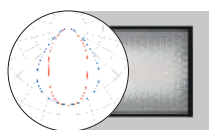

microprism
 direct

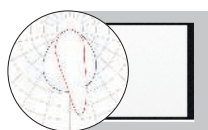

asymmetric
 direct

Size [mm]	low output		high output		low output		high output		
	[lm] / [W]	[lm] / [W]	[lm] / [W]	[lm] / [W]	[lm] / [W]	[lm] / [W]	[lm] / [W]		
1.225	1.818 / 16,3	3.463 / 30,0	1.652 / 16,3	3.162 / 30,0	1.735 / 16,3	3.320 / 30,0		3,3	
1.465	2.182 / 18,5	4.156 / 35,8	1.982 / 18,5	3.794 / 35,8	2.081 / 18,5	3.984 / 35,8		3,9	
1.705	2.546 / 21,2	4.848 / 41,1	2.313 / 21,2	4.427 / 41,1	2.429 / 21,2	4.648 / 41,1		4,5	
1.945	2.911 / 23,7	5.541 / 46,3	2.642 / 23,7	5.059 / 46,3	2.774 / 23,7	5.312 / 46,3		5,0	
2.185	3.273 / 26,6	6.233 / 52,0	2.974 / 26,6	5.692 / 52,0	3.123 / 26,6	5.977 / 52,0		5,6	
2.425	3.635 / 29,2	6.926 / 57,3	3.304 / 29,2	6.324 / 57,3	3.469 / 29,2	6.640 / 57,3		6,2	
2.905	4.364 / 34,3	8.311 / 69,6	3.964 / 34,3	7.589 / 69,6	4.162 / 34,3	7.968 / 69,6		7,4	
3.145	4.728 / 36,9	9.004 / 75,5	4.295 / 36,9	8.221 / 75,5	4.510 / 36,9	8.632 / 75,5		7,9	
3.867	5.821 / 47,4	11.082 / 92,6	5.284 / 47,4	10.118 / 92,6	5.548 / 47,4	10.624 / 92,6		9,7	

Alle Lumenangaben für 4000K, CRI>80, Microprisma ohne Opalfolie
 All lumen values for 4000K, CRI>80, microprism without opal foil
 Toutes les données de lumens pour 4000K, CRI>80, microprisme sans feuille opale

officeLINE50

HÄNGELEUCHE | PENDANT LUMINAIRE | LUMINAIRE SUSPENSION

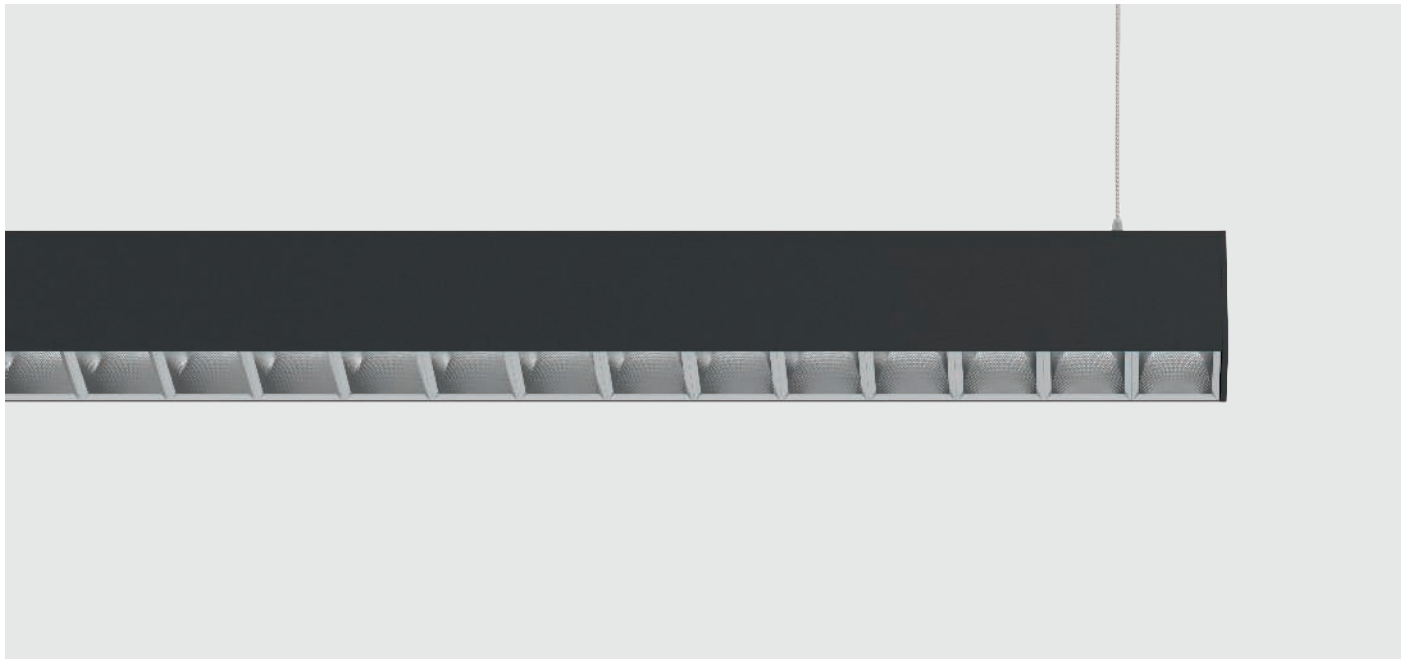

LED-Hängeleuchte direktstrahlend oder direkt-indirektstrahlend. Lichtkanal aus Aluminium-Strangpressprofil mit einer Breite von 50 mm. Fertigung der Leuchtenlänge millimetergenau auf Kundenwunsch möglich. Oberfläche der Leuchte feinstrukturiert matt pulverbeschichtet ähnlich RAL 9016 weiß, RAL 9006 silber oder RAL 9005 schwarz – auf Anfrage in RAL nach Wahl. Die Leuchte ist ausgestattet mit einem hochwertigen, facettierten BAP-Raster mit einer Auswahl an sieben verschiedenen Farben – Oberfläche hochglänzend bzw. matt. Leuchte inkl. weißem, rechteckigem Baldachin mit transparentem Einspeisekabel sowie flexiblen Seilabhängern und Schnellspannern zur stufenlosen Regulierung der Montagehöhe. Der LED-Treiber ist im Leuchtgehäuse integriert – wahlweise als on/off oder DALI-Variante. Farbtemperaturen 2700K, 3000K, 4000K oder dynamisch Weiß (2700K–6500K) – Farbwiedergabe CRI>80 oder CRI>90 – Mac Adam ≤3.

Pendant LED luminaire with direct beam or direct-indirect beam. Light channel made of extruded aluminium profile with a width of 50 mm. Luminaire length can be manufactured to the exact millimetre on customer request. Surface of the luminaire fine structure matt powder coated similar to RAL 9016 white, RAL 9006 silver or RAL 9005 black - on request in RAL of choice. The luminaire is equipped with a high-quality, faceted BAP louvre with a choice of seven different colours - surface specular or matt. Luminaire incl. white, rectangular canopy with transparent feeding cable as well as flexible wire suspension and quick-release clamps for continuous adjustment of mounting height. The LED driver is integrated in the luminaire housing - either as on/off or DALI version. Colour temperatures 2700K, 3000K, 4000K or dynamic white (2700K-6500K) - colour rendering CRI>80 or CRI>90 - Mac Adam ≤3.

Suspension LED à éclairage direct ou direct-indirect. Canal lumineux en profilé d'aluminium extrudé d'une largeur de 50 mm. Fabrication de la longueur du luminaire au millimètre près possible sur demande du client. Surface du luminaire à structure fine, revêtement par poudre mat similaire à RAL 9016 blanc, RAL 9006 argent ou RAL 9005 noir - sur demande en RAL au choix. Le luminaire est équipé d'une grille BAP à facettes de haute qualité avec un choix de sept couleurs différentes - surface brillante ou mate. Le luminaire rectangulaire blanc avec un câble d'alimentation transparent ainsi que des câbles flexibles et des fixations rapides permettant de régler la hauteur de montage en continu. Le pilote LED est intégré dans le boîtier du luminaire - au choix sous forme de variante on/off ou DALI. Températures de couleur 2700K, 3000K, 4000K ou blanc dynamique (2700K-6500K) - Rendu des couleurs CRI>80 ou CRI>90 - Mac Adam ≤3.

ÜBERSICHT | OVERVIEW | VUE D'ENSEMBLE

TECHNICAL DATA

2700K / 3000K / 4000K / 2700-6500K

CRI>80 / CRI>90

MacAdam ≤ 3

up to 162 lm/W, up to 7.425 lm/m

on-off / DALI

direct / direct + indirect

BAP-Louvre (UGR <19)

L80 B10 50.000h



RAL colour of your choice



Integration of 3-phase-track



Integration of Multisensor



Welded mitre cuts



Integration of emergency light



Integration of GLOWmini/
GLOWsmall series



Design Cables



Contact us for more options...

HOUSING COLOUR

schwarz | black | noir
RAL 9005



silber | silver | argent
RAL 9006



weiß | white | blanc
RAL 9016



DECORATION RING COLOUR

silber hochglanz | silver specular | argenté brillant



gold hochglanz | gold specular | doré brillant



silber matt | silver matt | argenté mat



bronze hochglanz | bronze specular | bronze brillant



schwarz hochglanz | black specular | noir brillant



titan hochglanz | titan specular | titan brillant



schwarz matt | black matt | noir mat



HÄNGELEUCHTE „officeLINE50“
 PENDANT LUMINAIRE “officeLINE50”
 LUMINAIRE SUSPENSION « officeLINE50 »

Bestellbeispiel | Example order | Exemple de commande
 3.372 mm, CRI>90, 4000K, direct + indirect, low output on/off, black, gold specular

OL50H-339402-LOBLG

1 2 3 4 5 6 7

1 LÄNGE
 LENGTH
 LONGEUR

1.211 mm	12
1.451 mm	14
1.691 mm	16
2.171 mm	21
2.891 mm	28
3.372 mm	33

2 FARBWIEDERGABE
 COLOUR RENDERING
 RENDU DES COULEURS

CRI>80	8
CRI>90	9

3 FARBTTEMPERATUR
 COLOUR TEMPERATURE
 TEMPÉRATURE DE COULEUR

2700K (CRI>90 only)	27
3000K	30
4000K	40
2700-6500K (CRI>90 only)	DW

4 LICHTVERTEILUNG
 LIGHT DISTRIBUTION
 DISTRIBUTION DE LA LUMIÈRE

direct	1
direct + indirect	2

5 LEISTUNG & STEUERUNG
 OUTPUT & CONTROL
 SORTIE & CONTRÔLE

low output on/off	LO
low output DALI	LD
high output on/off	HO
high output DALI	HD
dynamic white DALI DT8	DW

6 GEHÄUSEFARBE
 HOUSING COLOUR
 COULEUR DU BOÎTIER

silver RAL 9006	SI
white RAL 9016	WH
black RAL 9005	BL

7 BAP-RASTER FARBE
 BAP LOUVRE COLOUR
 GRILLE BAP COULEUR

silver specular	S
silver matt	M
black specular	N
black matt	B
gold specular	G
bronze specular	C
titan specular	T

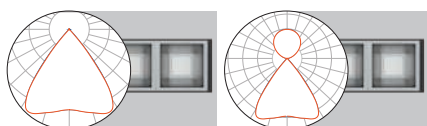
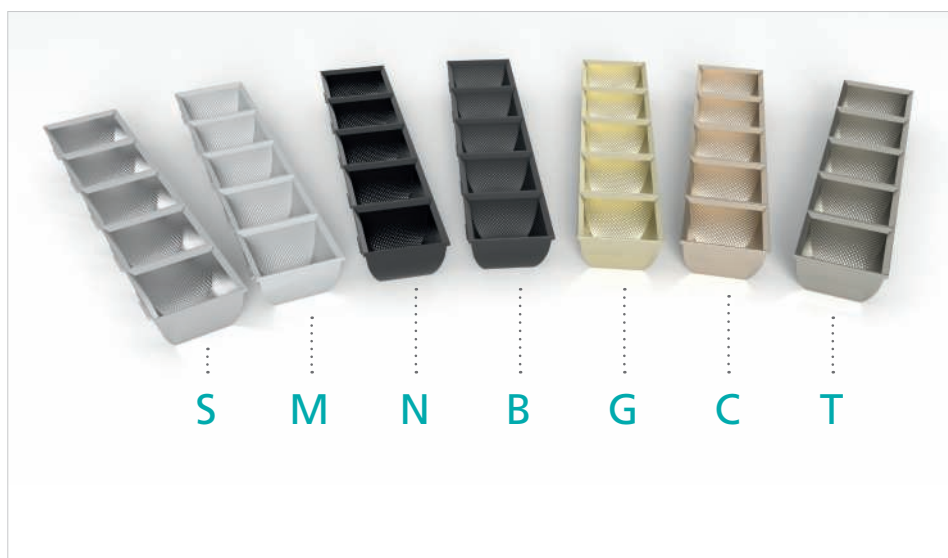
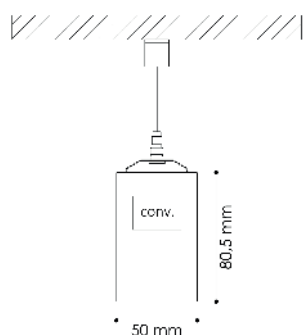

Size [mm]	direct		direct + indirect		direct	direct + indirect
	low output [lm] / [W]	high output [lm] / [W]	low output [lm] / [W]	high output [lm] / [W]	KG	KG
1.211	2.765 / 20,0	5.160 / 39,0	4.673 / 30,9	8.863 / 63,9	3,2	3,3
1.451	3.318 / 23,5	6.192 / 46,0	5.608 / 36,6	10.636 / 77,1	3,8	3,9
1.671	3.871 / 27,0	7.224 / 53,2	6.542 / 43,8	12.408 / 89,9	4,3	4,5
2.171	4.977 / 33,9	9.288 / 67,0	8.411 / 56,0	15.953 / 113,8	5,1	5,3
2.891	6.636 / 43,8	12.384 / 87,9	11.215 / 69,4	21.271 / 150,8	6,5	6,8
3.372	7.742 / 54,0	14.448 / 106,4	13.084 / 87,6	24.816 / 179,8	8,0	8,2

Alle Lumenangaben für 4000K, CRI>80, Reflektor silber hochglanz
 All lumen values for 4000K, CRI>80, reflector silver specular
 Toutes les données de lumens pour 4000K, CRI>80, réflecteur argenté brillant

officeLINE50

HÄNGELEUCHTE MIT SENSOR | PENDANT LUMINAIRE WITH SENSOR | LUMINAIRE SUSPENDOU AVEC CAPTEUR



LED-Hängeleuchte direktstrahlend oder direkt-indirektstrahlend. Lichtkanal aus Aluminium-Strangpressprofil mit einer Breite von 50 mm. Fertigung der Leuchtenlänge millimetergenau auf Kundenwunsch möglich. Oberfläche der Leuchte feinstruktur matt pulverbeschichtet ähnlich RAL 9016 weiß, RAL 9006 silber oder RAL 9005 schwarz – auf Anfrage in RAL nach Wahl. Die Leuchte ist ausgestattet mit einem hochwertigen, facettierten BAP-Raster mit einer Auswahl an sieben verschiedenen Farben – Oberfläche hochglänzend bzw. matt. Leuchte inkl. weißem, rechteckigem Baldachin mit transparentem Einspeisekabel sowie flexiblen Seilabhängern und Schnellspannern zur stufenlosen Regulierung der Montagehöhe. Der LED-Treiber ist im Leuchtengehäuse integriert. Farbtemperaturen 2700K, 3000K, 4000K oder dynamisch Weiß (2700K-6500K) – Farbwiedergabe CRI>80 oder CRI>90 – Mac Adam ≤3. Leuchte inkl. Bewegungs- und Tageslichtsensor – zusätzliche Farbregelung bei der dynamisch Weiß Variante – Sensor eingebaut in 240 mm langer Blindabdeckung. Weitere Steuerungsoptionen oder Lichtfarben auf Anfrage erhältlich. Außerdem ist die Integration vieler Komponenten, wie beispielsweise Notlicht, sowie eine Vielzahl weiterer Optionen möglich.

Pendant LED luminaire with direct beam or direct-indirect beam. Light channel made of extruded aluminium profile with a width of 50 mm. Luminaire length can be manufactured to the exact millimetre on customer request. Surface of the luminaire fine structure matt powder coated similar to RAL 9016 white, RAL 9006 silver or RAL 9005 black - on request in RAL of choice. The luminaire is equipped with a high-quality, faceted BAP louvre with a choice of seven different colours - surface specular or matt. Luminaire incl. white, rectangular canopy with transparent feeding cable as well as flexible wire suspension and quick-release clamps for continuous adjustment of mounting height. The LED driver is integrated in the luminaire housing - either as on/off or DALI version. Colour temperatures 2700K, 3000K, 4000K or dynamic white (2700K-6500K) - colour rendering CRI>80 or CRI>90 - Mac Adam ≤3. Luminaire incl. motion and daylight sensor - additional colour control for dynamic white version - sensor built into 240 mm long blind cover. Further control options or light colours available on request. In addition, the integration of many components, such as emergency lighting or sensor technology, as well as a variety of other options is possible.

Suspension LED à éclairage direct ou direct-indirect. Canal lumineux en profilé d'aluminium extrudé d'une largeur de 50 mm. Fabrication de la longueur du luminaire au millimètre près possible sur demande du client. Surface du luminaire à structure fine, revêtement par poudre mat similaire à RAL 9016 blanc, RAL 9006 argent ou RAL 9005 noir - sur demande en RAL au choix. Le luminaire est équipé d'une grille BAP à facettes de haute qualité avec un choix de sept couleurs différentes - surface brillante ou mate. Le luminaire rectangulaire blanc avec un câble d'alimentation transparent ainsi que des câbles flexibles et des fixations rapides permettant de régler la hauteur de montage en continu. Le pilote LED est intégré dans le boîtier du luminaire - au choix sous forme de variante on/off ou DALI. Températures de couleur 2700K, 3000K, 4000K ou blanc dynamique (2700K-6500K) - Rendu des couleurs CRI>80 ou CRI>90 - Mac Adam ≤3. Luminaire avec capteur de mouvement et de lumière du jour - réglage supplémentaire de la couleur pour la version blanc dynamique - capteur intégré dans un cache de 240 mm de long. Autres options de commande ou couleurs de lumière disponibles sur demande. En outre, l'intégration de nombreux composants, tels que l'éclairage de secours ou la technologie de détection, une multitude d'autres options sont possibles.

ÜBERSICHT | OVERVIEW | VUE D'ENSEMBLE

TECHNICAL DATA	
2700K / 3000K / 4000K / 2700-6500K	
CRI>80 / CRI>90	
MacAdam ≤ 3	
up to 162 lm/W, up to 7.425 lm/m	
DALI Sensor	
direct / direct + indirect	
BAP-Louvre (UGR <19)	
L80 B10 50.000h	



HOUSING COLOUR	
schwarz black noir RAL 9005	
silber silver argent RAL 9006	
weiß white blanc RAL 9016	

DECORATION RING COLOUR			
silber hochglanz silver specular argenté brillant		gold hochglanz gold specular doré brillant	
silber matt silver matt argenté mat		bronze hochglanz bronze specular bronze brillant	
schwarz hochglanz black specular noir brillant		titan hochglanz titan specular titan brillant	
schwarz matt black matt noir mat			

HÄNGELEUCHTE MIT SENSOR „officeLINE50“
PENDANT LUMINAIRE WITH SENSOR "officeLINE50"
LUMINAIRE SUSPENDOU AVEC CAPTEUR « officeLINE50 »

Bestellbeispiel | Example order | Exemple de commande
 1.451 mm, CRI>90, 4000K, direct + indirect, low output sensor, black, gold specular

OL50H-149402-LSBLG

1 2 3 4 5 6 7

1 LÄNGE
LENGTH
LONGEUR

1.451 mm	14
1.691 mm	16
1.931 mm	19

2 FARBWIEDERGABE
COLOUR RENDERING
RENDU DES COULEURS

CRI>80	8
CRI>90	9

3 FARBTEMPERATUR
COLOUR TEMPERATURE
TEMPÉRATURE DE COULEUR

2700K (CRI>90 only)	27
3000K	30
4000K	40
2700-6500K (CRI>90 only)	DW

4 LICHTVERTEILUNG
LIGHT DISTRIBUTION
DISTRIBUTION DE LA LUMIÈRE

direct	1
direct + indirect	2

5 LEISTUNG & STEUERUNG
OUTPUT & CONTROL
SORTIE & CONTRÔLE

low output sensor	LS
high output sensor	HS
dynamic white sensor (DW only)	DS

6 GEHÄUSEFARBE
HOUSING COLOUR
COULEUR DU BOÎTIER

silver RAL 9006	SI
white RAL 9016	WH
black RAL 9005	BL

7 BAP-RASTER FARBE
BAP LOUVRE COLOUR
GRILLE BAP COULEUR

silver specular	S
silver matt	M
black specular	N
black matt	B
gold specular	G
bronze specular	C
titan specular	T

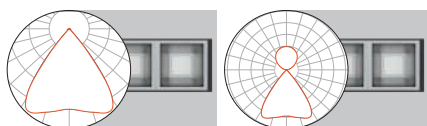
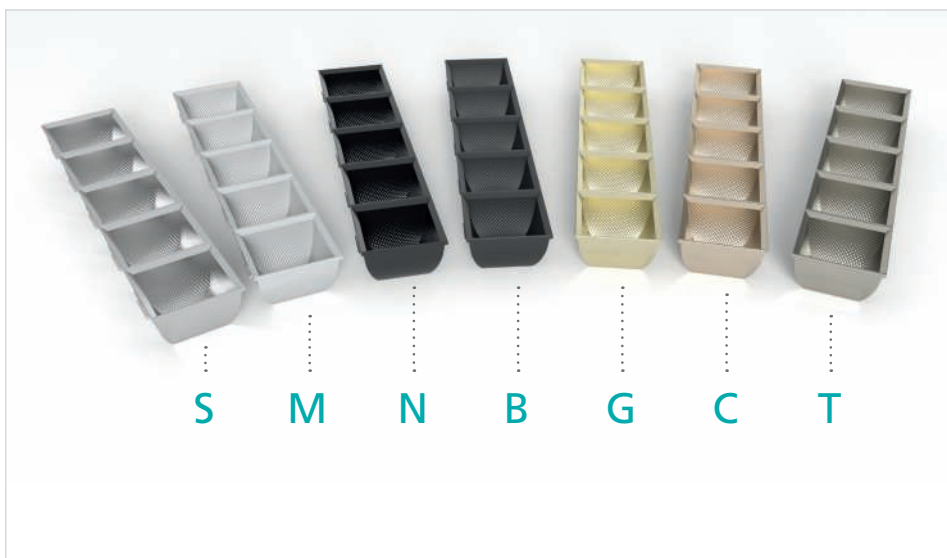
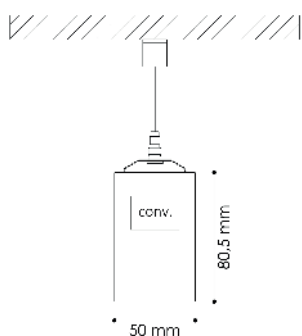

Size [mm]	direct		direct + indirect		direct [kg]	direct + indirect [kg]
	low output [lm] / [W]	high output [lm] / [W]	low output [lm] / [W]	high output [lm] / [W]		
1.451	2.765 / 20,5	5.160 / 39,4	4.673 / 32,6	8.863 / 66,9	3,8	3,9
1.691	3.318 / 24,0	6.192 / 46,5	5.608 / 38,3	10.636 / 79,8	4,3	4,5
1.931	3.871 / 27,6	7.224 / 53,8	6.542 / 45,5	12.408 / 92,2	4,9	5,0

Alle Lumenangaben für 4000K, CRI>80, Reflektor silber hochglanz
 All lumen values for 4000K, CRI>80, reflector silver specular
 Toutes les données de lumens pour 4000K, CRI>80, réflecteur argenté brillant

LINE70

HÄNGELEUCHE | PENDANT LUMINAIRE | LUMINAIRE SUSPENSION



LED-Hängeleuchte direktstrahlend oder direkt-indirektstrahlend. Lichtkanal aus Aluminium-Strangpressprofil mit einer Breite von 71 mm. Fertigung der Leuchtenlänge millimetergenau auf Kundenwunsch möglich. Oberfläche der Leuchte feinstruktur matt pulverbeschichtet ähnlich RAL 9016 weiß, RAL 9006 silber oder RAL 9005 schwarz – auf Anfrage in RAL nach Wahl. Diffusor wahlweise in PMMA opal oder PMMA klar mit eingeschobener mikroprismatischer Platte für eine reduzierte Leuchtdichte (UGR<19). Leuchte inkl. weißem, rechteckigem Baldachin mit transparentem Einspeisekabel sowie flexiblen Seilabhängern und Schnellspannern zur stufenlosen Regulierung der Montagehöhe. Der LED-Treiber ist im Leuchtengehäuse integriert – wahlweise als on/off oder DALI-Variante. Farbtemperaturen 2700K, 3000K, 4000K oder dynamisch Weiß (2700K–6500K) – Farbwiedergabe CRI>80 oder CRI>90 – Mac Adam ≤3. Weitere Steuerungsoptionen oder Lichtfarben auf Anfrage erhältlich. Außerdem ist die Integration vieler Komponenten, wie beispielsweise Notlicht oder Sensortechnologie, sowie eine Vielzahl weiterer Optionen möglich.

Pendant LED luminaire direct beam or direct-indirect beam. Light channel made of extruded aluminium profile with a width of 71 mm. Luminaire length can be manufactured to the exact millimetre on customer request. Surface of the luminaire fine structure matt powder coated similar to RAL 9016 white, RAL 9006 silver or RAL 9005 black - on request in RAL of choice. Diffuser either in PMMA opal or PMMA clear with inserted microprismatic plate for reduced luminance (UGR<19). Luminaire incl. white, rectangular canopy with transparent feeding cable as well as flexible cord suspensions and quick-release clamps for continuous adjustment of mounting height. The LED driver is integrated in the luminaire housing - either as on/off or DALI version. Colour temperatures 2700K, 3000K, 4000K or dynamic white (2700K-6500K) - colour rendering CRI>80 or CRI>90 - Mac Adam ≤3. Further control options or light colours available on request. In addition, the integration of many components, such as emergency lighting or sensor technology, as well as a variety of other options is possible.

Suspension LED à éclairage direct ou direct-indirect. Canal lumineux en profilé d'aluminium extrudé d'une largeur de 71 mm. Fabrication de la longueur du luminaire au millimètre près possible sur demande du client. Surface du luminaire à structure fine, revêtement par poudre mat similaire à RAL 9016 blanc, RAL 9006 argent ou RAL 9005 noir - sur demande en RAL au choix. Diffuseur au choix en PMMA opale ou en PMMA transparent avec plaque microprismatique insérée pour un éblouissement réduit (UGR<19). Luminaire avec rosace rectangulaire blanche, câble d'alimentation transparent, de câble flexibles et tendeurs rapides permettant de régler la hauteur de montage en continu. Le pilote LED est intégré dans le boîtier du luminaire - au choix sous forme de variante on/off ou DALI. Températures de couleur 2700K, 3000K, 4000K ou blanc dynamique (2700K-6500K) - Rendu des couleurs CRI>80 ou CRI>90 - Mac Adam ≤3. Autres options de commande ou couleurs de lumière disponibles sur demande. En outre, l'intégration de nombreux composants, tels que l'éclairage de secours ou la technologie de détection, une multitude d'autres options sont possibles.

ÜBERSICHT | OVERVIEW | VUE D'ENSEMBLE

TECHNICAL DATA

2700K / 3000K / 4000K / 2700-6500K

CRI>80 / CRI>90

MacAdam ≤ 3

up to 161 lm/W, up to 6.958 lm/m

on-off / DALI

direct / direct + indirect

opal / microprism (UGR <19)

L80 B10 50.000h

HOUSING COLOUR

schwarz | black | noir
RAL 9005

silber | silver | argent
RAL 9006

weiß | white | blanc
RAL 9016



RAL colour of your choice



Integration of Multisensor



Welded mitre cuts



Integration of emergency light



Design Cables



Contact us for more options...

HÄNGELEUCHTE „LINE70“
 PENDANT LUMINAIRE “LINE70”
 LUMINAIRE SUSPENSION « LINE70 »

Bestellbeispiel | Example order | Exemple de commande
 3.134 mm, CRI>90, 4000K, direct + indirect, low output on/off, black, microprism

LI70H-319402-LOBLM

1 2 3 4 5 6 7

1 LÄNGE LENGTH LONGEUR	
1.214 mm	12
1.454 mm	14
1.694 mm	16
1.934 mm	19
2.174 mm	21
2.414 mm	24
2.894 mm	28
3.134 mm	31
3.856 mm	38

2 FARBWIEDERGABE COLOUR RENDERING RENDU DES COULEURS	
CRI>80	8
CRI>90	9

3 FARBTEMPERATUR COLOUR TEMPERATURE TEMPÉRATURE DE COULEUR	
2700K (CRI>90 only)	27
3000K	30
4000K	40
2700-6500K (CRI>90 only)	DW

4 LICHTVERTEILUNG LIGHT DISTRIBUTION DISTRIBUTION DE LA LUMIÈRE	
direct	1
direct + indirect	2

5 LEISTUNG & STEUERUNG OUTPUT & CONTROL SORTIE & CONTRÔLE	
low output on/off	LO
low output DALI	LD
high output on/off	HO
high output DALI	HD
dynamic white DALI DT8	DW

6 GEHÄUSEFARBE HOUSING COLOUR COULEUR DU BOÎTIER	
silver RAL 9006	SI
white RAL 9016	WH
black RAL 9005	BL

7 DIFFUSOR DIFFUSER DIFFUSEUR	
opal	O
microprism	M

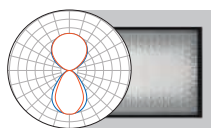
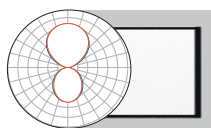
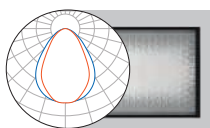
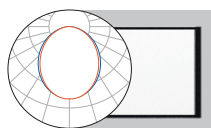
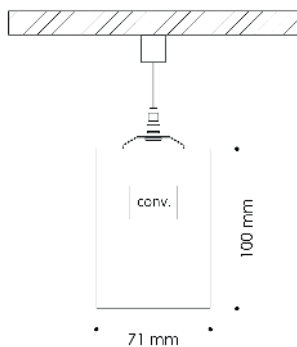

Size [mm]	opal direct		microprism direct		opal direct + indirect		microprism direct + indirect		direct	direct + indirect
	low output [lm] / [W]	high output [lm] / [W]	low output [lm] / [W]	high output [lm] / [W]	low output [lm] / [W]	high output [lm] / [W]	low output [lm] / [W]	high output [lm] / [W]	kg	kg
1.214	2.154 / 18,8	3.418 / 30,0	2.090 / 18,8	3.216 / 30,0	5.136 / 35,4	8.176 / 57,2	5.072 / 35,4	7.974 / 57,2	3,6	4,2
1.454	2.585 / 22,1	4.102 / 35,8	2.508 / 22,1	3.859 / 35,8	6.163 / 41,6	9.811 / 68,1	6.086 / 41,6	9.569 / 68,1	4,2	4,8
1.694	3.016 / 25,5	4.785 / 41,1	2.926 / 25,5	4.502 / 41,1	7.190 / 47,9	11.446 / 80,8	7.100 / 47,9	11.164 / 80,8	4,9	5,5
1.934	3.446 / 28,7	5.469 / 46,3	3.344 / 28,7	5.146 / 46,3	8.218 / 54,5	13.082 / 91,7	8.116 / 54,5	12.758 / 91,7	5,4	6,1
2.174	3.877 / 32,0	6.152 / 52,0	3.762 / 32,0	5.789 / 52,0	9.245 / 60,8	14.717 / 103,0	9.130 / 60,8	14.353 / 103,0	6,1	6,7
2.414	4.308 / 35,4	6.836 / 57,3	4.180 / 35,4	6.432 / 57,3	10.272 / 65,4	16.352 / 113,1	10.144 / 65,4	15.948 / 113,1	6,8	7,5
2.894	5.170 / 41,6	8.203 / 69,6	5.016 / 41,6	7.718 / 69,6	12.326 / 77,4	19.622 / 134,8	12.172 / 77,4	19.138 / 134,8	8,0	8,8
3.134	5.600 / 44,8	8.887 / 75,5	5.434 / 44,8	8.362 / 75,5	13.354 / 83,4	21.258 / 145,3	13.189 / 83,4	20.732 / 145,3	8,6	9,4
3.856	6.892 / 57,4	10.938 / 92,6	6.688 / 57,4	10.292 / 92,6	16.436 / 109,0	26.164 / 183,4	16.232 / 109,0	25.516 / 183,4	10,8	11,7

Alle Lumenangaben für 4000K, CRI>80, Microprisma ohne Opalfolie
 All lumen values for 4000K, CRI>80, microprism without opal foil
 Toutes les données de lumens pour 4000K, CRI>80, microprisme sans feuille opale

RING50

HÄNGELEUCHE | PENDANT LUMINAIRE | LUMINAIRE SUSPENSION



Ringförmige LED-Hängeleuchte direktstrahlend oder direkt-indirektstrahlend. Lichtkanal aus gerolltem Aluminiumprofil mit einer Breite von 50 mm. Leuchte erhältlich in neun verschiedenen Durchmessern – 1220 und 1575 mm in einem Stück nahtlos verschweißt – die restlichen Größen (2020, 2595, 3090, 3535, 4070, 5050, 6075 mm) bestehend aus zwei bis neun gleich großen Segmenten. Oberfläche der Leuchte feinstruktur matt pulverbeschichtet ähnlich RAL 9016 weiß, RAL 9006 silber oder RAL 9005 schwarz – auf Anfrage in RAL nach Wahl. Diffusor wahlweise in PMMA opal oder PMMA klar mit mikroprismatischer Prägung für eine reduzierte Leuchtdichte (UGR<19). Leuchte inkl. weißem, rundem Baldachin mit transparentem Einspeisekabel sowie flexiblen Seilabhängern und Schnellspannern zur stufenlosen Regulierung der Montagehöhe. Der LED-Treiber ist im Leuchtgehäuse integriert – wahlweise als on/off oder DALI-Variante. Farbtemperaturen 2700K, 3000K, 4000K oder dynamisch Weiß (2700K–6500K) – Farbwiedergabe CRI>80 oder CRI>90 – Mac Adam ≤3. Weitere Steuerungsoptionen oder Lichtfarben auf Anfrage erhältlich. Außerdem ist die Integration vieler Komponenten, wie beispielsweise Notlicht oder Sensortechnologie, sowie eine Vielzahl weiterer Optionen möglich.

Ring-shaped pendant LED luminaire with direct beam or direct-indirect beam. Light channel made of rolled aluminium profile with a width of 50 mm. Luminaire available in nine different diameters - 1220 and 1575 mm seamlessly welded in one piece - the remaining sizes (2020, 2595, 3090, 3535, 4070, 5050, 6075 mm) consisting of two to nine equally sized segments. Surface of the luminaire fine structure matt powder coated similar to RAL 9016 white, RAL 9006 silver or RAL 9005 black - on request in RAL of choice. Diffuser either in PMMA opal or PMMA clear with microprismatic pattern for reduced luminance (UGR<19). Luminaire incl. white, round canopy with transparent feeding cable as well as flexible cord suspension and quick-release clamps for continuous adjustment of the mounting height. The LED driver is integrated in the luminaire housing - either as on/off or DALI version. Colour temperatures 2700K, 3000K, 4000K or dynamic white (2700K-6500K) - colour rendering CRI>80 or CRI>90 - Mac Adam ≤3. Further control options or light colours available on request. In addition, the integration of many components, such as emergency lighting or sensor technology, as well as a variety of other options is possible.

Suspension anneau LED à éclairage direct ou direct-indirect. Canal lumineux en profilé d'aluminium roulé d'une largeur de 50 mm. Luminaire disponible en neuf diamètres différents - 1220 et 1575 mm en une seule pièce soudée sans soudure - les autres tailles (2020, 2595, 3090, 3535, 4070, 5050, 6075 mm) se composent de deux à neuf segments de même taille. Surface du luminaire à structure fine matte revêtue par poudre similaire à RAL 9016 blanc, RAL 9006 argent ou RAL 9005 noir - sur demande en RAL au choix. Diffuseur au choix en PMMA opale ou en PMMA transparent avec gaufrage microprismatique pour un éblouissement réduit (UGR<19). Luminaire blanc avec un câble d'alimentation transparent ainsi que des câbles flexibles et des tendeurs rapides permettant de régler la hauteur de montage en continu. Le pilote LED est intégré dans le boîtier du luminaire - au choix en version on/off ou DALI. Températures de couleur 2700K, 3000K, 4000K ou blanc dynamique (2700K-6500K) - Rendu des couleurs CRI>80 ou CRI>90 - Mac Adam ≤3. Autres options de commande ou couleurs de lumière disponibles sur demande. En outre, l'intégration de nombreux composants, tels que l'éclairage de secours ou la technologie de détection, une multitude d'autres options sont possibles.

ÜBERSICHT | OVERVIEW | VUE D'ENSEMBLE

TECHNICAL DATA

2700K / 3000K / 4000K / 2700-6500K

CRI>80 / CRI>90

MacAdam ≤ 3

up to 136 lm/W

on-off / DALI

direct / direct + indirect

opal / microprism (UGR <19)

L80 B10 50.000h

HOUSING COLOUR

schwarz | black | noir
RAL 9005

silber | silver | argent
RAL 9006

weiß | white | blanc
RAL 9016



RAL colour of your choice



Integration of emergency light



Design Cables



Contact us for more options...

HÄNGELEUCHTE „RING50“

PENDANT LUMINAIRE “RING50”

LUMINAIRE SUSPENSION « RING50 »

Bestellbeispiel | Example order | Exemple de commande

Standard Suspension, 6.075 mm, CRI>90, 4000K, direct + indirect, low output on/off, black, microprism

RG50H-609402-LOBLM

1 2 3 4 5 6 7 8

1 ABHÄNGUNG SUSPENSION SUSPENSION

Standard	H
Central (1.220 / 1.575 mm only)	Z
Y-Suspension (1.220 / 1.575 mm only)	Y

2 DURCHMESSER DIAMETER DIAMÈTRE

1.220 mm (no DW)	12
1.575 mm (no DW)	15
2.020 mm	20
2.595 mm	25
3.090 mm	30
3.535 mm	35
4.070 mm	40
5.050 mm	50
6.075 mm	60

3 FARBWIEDERGABE COLOUR RENDERING RENDU DES COULEURS

CRI>80	8
CRI>90	9

4 FARBTEMPERATUR COLOUR TEMPERATURE TEMPÉRATURE DE COULEUR

2700K (CRI>90 only)	27
3000K	30
4000K	40
2700-6500K (CRI>90 only)	DW

5 LICHTVERTEILUNG LIGHT DISTRIBUTION DISTRIBUTION DE LA LUMIÈRE

direct	1
direct + indirect	2

6 LEISTUNG & STEUERUNG OUTPUT & CONTROL SORTIE & CONTRÔLE

low output on/off	LO
low output DALI	LD
high output on/off	HO
high output DALI	HD
dynamic white DALI DT8	DW

7 GEHÄUSEFARBE HOUSING COLOUR COULEUR DU BOÎTIER

silver RAL 9006	SI
white RAL 9016	WH
black RAL 9005	BL

8 DIFFUSOR DIFFUSER DIFFUSEUR

opal	O
microprism	M

Code Standard: H

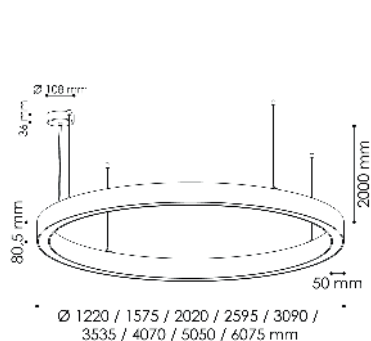

Code Central: Z

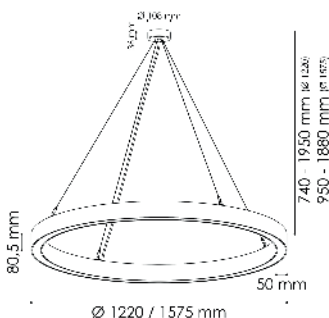

Code Y-Suspension: Y

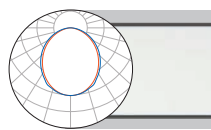
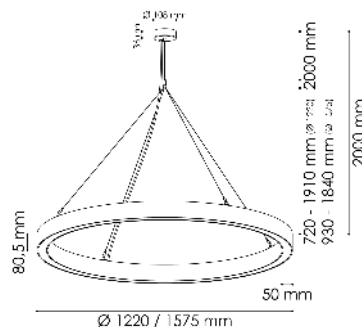

opal direct

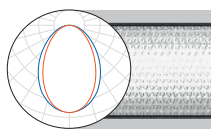

microprism direct

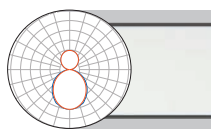

opal direct + indirect

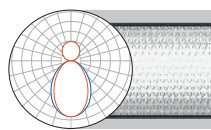

microprism direct + indirect

direct

direct + indirect

Size [mm]	low output [lm] / [W]		high output [lm] / [W]		low output [lm] / [W]		high output [lm] / [W]		direct [kg]	direct + indirect [kg]
	low output [lm] / [W]	high output [lm] / [W]	low output [lm] / [W]	high output [lm] / [W]	low output [lm] / [W]	high output [lm] / [W]	low output [lm] / [W]	high output [lm] / [W]		
Ø 1.220	4.888 / 38,3	8.376 / 66,3	5.026 / 38,3	8.616 / 66,3	7.402 / 55,3	12.688 / 95,1	7.539 / 55,3	12.920 / 95,1	9,9	10,5
Ø 1.575	6.110 / 51,2	10.470 / 86,6	6.283 / 51,2	10.770 / 86,6	9.252 / 71,9	15.860 / 122,1	9.424 / 71,9	16.150 / 122,1	12,8	13,6
Ø 2.020	7.943 / 65,0	13.611 / 113,2	8.168 / 65,0	14.001 / 113,2	12.028 / 93,2	20.618 / 161,6	12.251 / 93,2	20.995 / 161,6	16,5	17,5
Ø 2.595	10.387 / 85,0	17.799 / 147,9	10.681 / 85,0	18.309 / 147,9	15.728 / 118,8	26.962 / 207,5	16.021 / 118,8	27.455 / 207,5	21,1	22,4
Ø 3.090	12.220 / 102,4	20.940 / 178,0	12.566 / 102,4	21.540 / 178,0	18.504 / 143,4	31.720 / 250,0	18.848 / 143,4	32.300 / 250,0	25,2	26,7
Ø 3.535	14.053 / 120,7	24.081 / 209,0	14.451 / 120,7	24.771 / 209,0	21.280 / 164,6	36.478 / 286,5	21.675 / 164,6	37.145 / 286,5	28,8	30,6
Ø 4.070	15.886 / 137,0	27.222 / 238,0	16.336 / 137,0	28.002 / 238,0	24.055 / 186,8	41.236 / 325,5	24.502 / 186,8	41.990 / 325,5	33,2	35,2
Ø 5.050	20.163 / 172,0	34.551 / 298,0	20.734 / 172,0	35.541 / 298,0	30.532 / 238,0	52.338 / 414,6	31.099 / 238,0	53.295 / 414,6	41,1	43,6
Ø 6.075	23.829 / 205,5	40.833 / 357,0	24.504 / 205,5	42.003 / 357,0	36.083 / 280,3	61.854 / 488,3	36.754 / 280,3	62.985 / 488,3	49,5	52,5

Alle Lumenangaben für 4000K, CRI>80, Gehäusefarbe weiß

All lumen values for 4000K, CRI>80, housing colour white

Toutes les données de lumens pour 4000K, CRI>80, couleur du boîtier blanc

RING50mute

HÄNGELEUCHE | PENDANT LUMINAIRE | LUMINAIRE SUSPENSION



Ringförmige LED-Hängeleuchte direktstrahlend oder direkt-indirektstrahlend. Lichtkanal aus gerolltem Aluminiumprofil mit einer Breite von 50 mm. Leuchte erhältlich in zwei verschiedenen Durchmessern mit integrierten Akustikelemente – 1220 und 1575 mm in einem Stück nahtlos verschweißt. Oberfläche der Leuchte feinstruktur matt pulverbeschichtet ähnlich RAL 9016 weiß, RAL 9006 silber oder RAL 9005 schwarz – auf Anfrage in RAL nach Wahl. Akustikelemente aus recyceltem PET in schwarz, hellgrau meliert, anthrazit meliert, burgunderrot oder olivgrün auswählbar. Diffusor wahlweise in PMMA opal oder PMMA klar mit mikroprismatischer Prägung für eine reduzierte Leuchtdichte (UGR<19). Leuchte inkl. weißem, rundem Baldachin mit transparentem Einspeisekabel sowie flexiblen Seilabhängern und Schnellspannern zur stufenlosen Regulierung der Montagehöhe. Der LED-Treiber ist im Leuchtgehäuse integriert – wahlweise als on/off oder DALI-Variante. Farbtemperaturen 2700K, 3000K oder 4000K – Farbwiedergabe CRI>80 oder CRI>90 – Mac Adam ≤3. Weitere Steuerungsoptionen oder Lichtfarben auf Anfrage erhältlich. Außerdem ist die Integration vieler Komponenten, wie beispielsweise Notlicht oder Sensortechnologie, sowie eine Vielzahl weiterer Optionen möglich.

Ring-shaped pendant LED luminaire with direct beam or direct-indirect beam. Light channel made of rolled aluminium profile with a width of 50 mm. Luminaire available in two different diameters with integrated acoustic elements – 1220 and 1575 mm seamlessly welded in one piece. Surface of the luminaire fine structure matt powder coated similar to RAL 9016 white, RAL 9006 silver or RAL 9005 black - on request in RAL of choice. Acoustic elements made of recycled PET available in black, light grey mottled, anthracite mottled, burgundy red or olive green. Diffuser either in PMMA opal or PMMA clear with microprismatic pattern for reduced luminance (UGR<19). Luminaire incl. white, round canopy with transparent feeding cable as well as flexible cord suspension and quick-release clamps for continuous adjustment of the mounting height. The LED driver is integrated in the luminaire housing - either as on/off or DALI version. Colour temperatures 2700K, 3000K or 4000K - colour rendering CRI>80 or CRI>90 - Mac Adam ≤3. Further control options or light colours available on request. In addition, the integration of many components, such as emergency lighting or sensor technology, as well as a variety of other options is possible.

Suspension anneau LED à éclairage direct ou direct-indirect. Canal lumineux en profilé d'aluminium roulé d'une largeur de 50 mm. Luminaire disponible en deux diamètres différents avec élément acoustique intégré - 1220 et 1575 mm en une seule pièce soudée sans soudure. Surface du luminaire à structure fine matte revêtue par poudre similaire à RAL 9016 blanc, RAL 9006 argent ou RAL 9005 noir - sur demande en RAL au choix. Éléments acoustiques fabriqués en PET recyclé en noir, gris clair chiné, anthracite chiné, rouge bordeaux ou vert olive au choix. Diffuseur au choix en PMMA opale ou en PMMA transparent avec gaufrage microprismatique pour un éblouissement réduit (UGR<19). Luminaire rond blanc avec un câble d'alimentation transparent ainsi que des câbles flexibles et des tendeurs rapides permettant de régler la hauteur de montage en continu. Le pilote LED est intégré dans le boîtier du luminaire - au choix en version on/off ou DALI. Températures de couleur 2700K, 3000K ou 4000K - Rendu des couleurs CRI>80 ou CRI>90 - Mac Adam ≤3. Autres options de commande ou couleurs de lumière disponibles sur demande. En outre, l'intégration de nombreux composants, tels que l'éclairage de secours ou la technologie de détection, une multitude d'autres options sont possibles.

ÜBERSICHT | OVERVIEW | VUE D'ENSEMBLE

TECHNICAL DATA

2700K / 3000K / 4000K

CRI>80 / CRI>90

MacAdam ≤ 3

up to 136 lm/W

on-off / DALI

direct / direct + indirect

opal / microprism (UGR <19)

L80 B10 50.000h

acoustic material - fire classification: B-s2, d0 (EN13501-1:3018)

HOUSING COLOUR

schwarz | black | noir
RAL 9005

silber | silver | argent
RAL 9006

weiß | white | blanc
RAL 9016



RAL colour of your choice



Integration of emergency light



Design Cables



Contact us for more options...

COLOUR ACOUSTIC PANEL

schwarz | black | noir

hellgrau meliert | light grey mottled|
gris clair chiné

anthrazit meliert | anthracite mottled|
anthracite chiné

burgunderrot | burgundy red | rouge bourgogne

olivgrün | olive green | vert olive

HÄNGELEUCHTE „RING50mute“
 PENDANT LUMINAIRE “RING50mute”
 LUMINAIRE SUSPENSION « RING50mute »

Bestellbeispiel | Example order | Exemple de commande
 Standard Suspension, 1.220 mm, CRI90, 4000K, direct, low output on/off, black, olive, microprism

RG5MH-129401-LOBOM

1 2 3 4 5 6 7 8 9

1 ABHÄNGUNG
 SUSPENSION
 SUSPENSION

Standard	H
Central	Z
Y-Suspension	Y

2 DURCHMESSER
 DIAMETER
 DIAMÈTRE

1.220 mm	12
1.575 mm	15

3 FARBWIEDERGABE
 COLOUR RENDERING
 RENDU DES COULEURS

CRI>80	8
CRI>90	9

4 FARBTEMPERATUR
 COLOUR TEMPERATURE
 TEMPÉRATURE DE COULEUR

2700K (CRI>90 only)	27
3000K	30
4000K	40

5 LICHTVERTEILUNG
 LIGHT DISTRIBUTION
 DISTRIBUTION DE LA LUMIÈRE

direct	1
direct + indirect	2

6 LEISTUNG & STEUERUNG
 OUTPUT & CONTROL
 SORTIE & CONTRÔLE

low output on/off	LO
low output DALI	LD
high output on/off	HO
high output DALI	HD

7 GEHÄUSEFARBE
 HOUSING COLOUR
 COULEUR DU BOÎTIER

silver RAL 9006	S
white RAL 9016	W
black RAL 9005	B

8 FARBE AKUSTIKPLATTE
 COLOUR ACOUSTIC PANEL
 COULEUR PANNEAU ACOUSTIQUE

black	B
light grey mottled	S
anthracite mottled	A
burgundy red	R
olive green	O

9 DIFFUSOR
 DIFFUSER
 DIFFUSEUR

opal	O
microprism	M

Code Standard: **H**

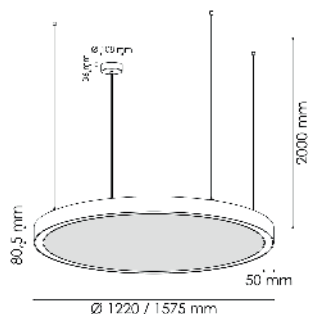

Code Central: **Z**

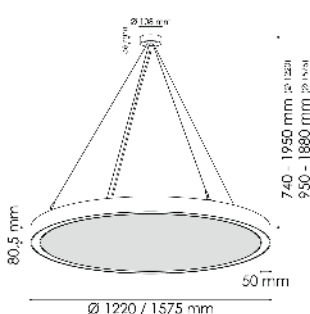

Code Y-Suspension: **Y**

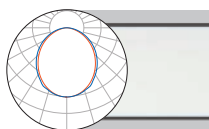
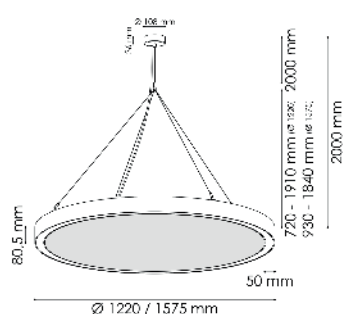

opal
direct

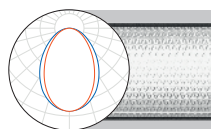

microprism
direct

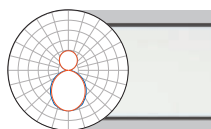

opal
direct + indirect

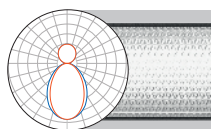

microprism
direct + indirect

direct

direct +
indirect

Size [mm]	low output [lm] / [W]		high output [lm] / [W]		low output [lm] / [W]		high output [lm] / [W]		kg	kg
	low output	high output	low output	high output	low output	high output	low output	high output		
Ø 1.220	4.888 / 38,3	8.376 / 66,3	5.026 / 38,3	8.616 / 66,3	7.402 / 55,3	12.688 / 95,1	7.539 / 55,3	12.920 / 95,1	14,0	14,6
Ø 1.575	6.110 / 51,2	10.470 / 86,6	6.283 / 51,2	10.770 / 86,6	9.252 / 71,9	15.860 / 122,1	9.424 / 71,9	16.150 / 122,1	19,8	20,6

Alle Lumenangaben für 4000K, CRI>80, Gehäusefarbe weiß
 All lumen values for 4000K, CRI>80, housing colour white
 Toutes les données de lumens pour 4000K, CRI>80, couleur du boîtier blanc

FLEX50

HÄNGELEUCHE | PENDANT LUMINAIRE | LUMINAIRE SUSPENSION



LED-Hängeleuchte als Segment zur individuellen Kombination. Direktstrahlend oder direkt-indirektstrahlend. Lichtkanal aus gerolltem Aluminiumprofil mit einer Breite von 50 mm. Segmente erhältlich in 13 verschiedenen Varianten – zwei Stück als gerades Profil 980 oder 1960 mm – die restlichen Segmente sind als 40°, 45°, 60°- bzw. 90°-Stücke mit einem Mittenradius von 585 bis 3012,5 mm erhältlich. Oberfläche der Leuchte feinstruktur matt pulverbeschichtet ähnlich RAL 9016 weiß, RAL 9006 silber oder RAL 9005 schwarz – auf Anfrage in RAL nach Wahl. Diffusor wahlweise in PMMA opal oder PMMA klar mit mikroprismatischer Prägung für eine reduzierte Leuchtdichte (UGR<19). Leuchte inkl. weißem, rundem Baldachin mit transparentem Einspeisekabel sowie flexiblen Seilabhängern und Schnellspannern zur stufenlosen Regulierung der Montagehöhe. Der LED-Treiber ist im Leuchtgehäuse integriert – wahlweise als on/off oder DALI-Variante. Farbtemperaturen 2700K, 3000K, 4000K oder dynamisch Weiß (2700K–6500K) – Farbwiedergabe CRI>80 oder CRI>90 – Mac Adam ≤3. Weitere Steuerungsoptionen oder Lichtfarben auf Anfrage erhältlich. Außerdem ist die Integration vieler Komponenten, wie beispielsweise Notlicht oder Sensortechnologie, sowie eine Vielzahl weiterer Optionen möglich.

Pendant LED luminaire as segment for individual combination. Direct beam or direct-indirect beam. Light channel made of rolled aluminium profile with a width of 50 mm. Segments available in 13 different versions - two pieces as straight profile 980 or 1960 mm - the remaining segments are available as 40°, 45°, 60° or 90° pieces with a middle radius of 585 to 3012.5 mm. Surface of the luminaire fine structure matt powder coated similar to RAL 9016 white, RAL 9006 silver or RAL 9005 black - on request in RAL of choice. Diffuser either in PMMA opal or PMMA clear with microprismatic pattern for reduced luminance (UGR<19). Luminaire incl. white, round canopy with transparent feeding cable as well as flexible cord suspension and quick-release clamps for continuous adjustment of mounting height. The LED driver is integrated in the luminaire housing - either as on/off or DALI version. Colour temperatures 2700K, 3000K, 4000K or dynamic white (2700K-6500K) - colour rendering CRI>80 or CRI>90 - Mac Adam ≤3. Further control options or light colours available on request. In addition, the integration of many components, such as emergency lighting or sensor technology, as well as a variety of other options is possible.

Luminaire LED suspendu sous segment pour une combinaison individuelle. Éclairage direct ou éclairage direct-indirect. Canal lumineux en profilé d'aluminium roulé d'une largeur de 50 mm. Segments disponibles en 13 variantes différentes - deux pièces sous forme de profilé droit de 980 ou 1960 mm - les autres segments sont disponibles sous forme de pièces de 40°, 45°, 60° ou 90° avec un rayon central de 585 à 3012,5 mm. Surface du luminaire à structure fine matte revêtue par poudre similaire à RAL 9016 blanc, RAL 9006 argent ou RAL 9005 noir - sur demande en RAL au choix. Diffuseur au choix en PMMA opale ou en PMMA transparent avec gaufrage microprismatique pour un éblouissement réduit (UGR<19). Luminaire rond blanc avec un câble d'alimentation transparent ainsi que des câbles flexibles et des tendeurs rapides permettant de régler la hauteur de montage en continu. Le pilote LED est intégré dans le boîtier du luminaire - au choix sous forme de variante on/off ou DALI. Températures de couleur 2700K, 3000K, 4000K ou blanc dynamique (2700K-6500K) - Rendu des couleurs CRI>80 ou CRI>90 - Mac Adam ≤3. Autres options de commande ou couleurs de lumière disponibles sur demande. En outre, l'intégration de nombreux composants, tels que l'éclairage de secours ou la technologie de détection, une multitude d'autres options sont possibles.

ÜBERSICHT | OVERVIEW | VUE D'ENSEMBLE

TECHNICAL DATA

2700K / 3000K / 4000K / 2700-6500K

CRI>80 / CRI>90

MacAdam ≤ 3

up to 136 lm/W

on-off / DALI

direct / direct + indirect

opal / microprism (UGR <19)

L80 B10 50.000h

HOUSING COLOUR

schwarz | black | noir
RAL 9005

silber | silver | argent
RAL 9006

weiß | white | blanc
RAL 9016



RAL colour of your choice



Integration of emergency light



Design Cables



Contact us for more options...

HÄNGELEUCHTE „FLEX50“
 PENDANT LUMINAIRE "FLEX50"
 LUMINAIRE SUSPENSION « FLEX50 »

Bestellbeispiel | Example order | Exemple de commande
 straight, 1.960 mm, CRI>90, 4000K, direct + indirect, low output on/off, black, microprism

FX50H-L29402-LOBLM

- 1 2 3 4 5 6 7

1 GRÖSSE SIZE TAILLE	
straight, L 980 mm	L1
straight, L 1.960 mm	L2
90°, R 585 mm (no DW)	19
90°, R 762,5 mm (no DW)	29
90°, R 985 mm	39
45°, R 1.272,5 mm	44
90°, R 1.272,5 mm	49
60°, R 1.520 mm	56
90°, R 1.520 mm	59
60°, R 1.742,5 mm	66
60°, R 2.010 mm	76
45°, R 2.500 mm	84
40°, R 3.012,5 mm	94

2 FARBWIEDERGABE COLOUR RENDERING RENDU DES COULEURS	
CRI>80	8
CRI>90	9

3 FARBTEMPERATUR COLOUR TEMPERATURE TEMPÉRATURE DE COULEUR	
2700K (CRI>90 only)	27
3000K	30
4000K	40
2700-6500K (CRI>90 only)	DW

4 LICHTVERTEILUNG LIGHT DISTRIBUTION DISTRIBUTION DE LA LUMIÈRE	
direct	1
direct + indirect	2

5 LEISTUNG & STEUERUNG OUTPUT & CONTROL SORTIE & CONTRÔLE	
low output on/off	LO
low output DALI	LD
high output on/off	HO
high output DALI	HD
dynamic white DALI DT8	DW

6 GEHÄUSEFARBE HOUSING COLOUR COULEUR DU BOÎTIER	
silver RAL 9006	SI
white RAL 9016	WH
black RAL 9005	BL

7 DIFFUSOR DIFFUSER DIFFUSEUR	
opal	O
microprism	M

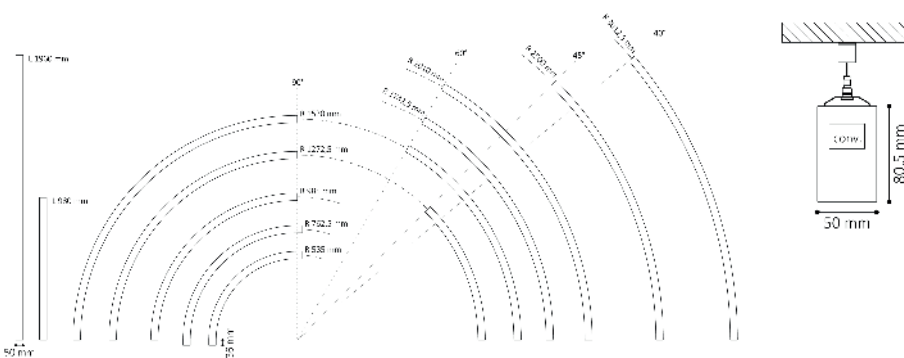

ACCESSORIES	
END CAPS - 2 pcs.	
black	FX50H-EC-BL
silver	FX50H-EC-SI
white	FX50H-EC-WH
POWER FEEDING - 2.000 mm	
5-pole	FX50H-PF-5
3-pole	FX50H-PF-3

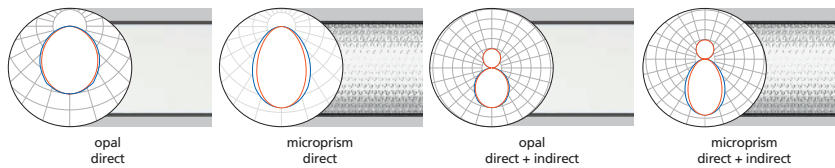

Size [mm]	opal direct		microprism direct		opal direct + indirect		microprism direct + indirect		direct [kg]	direct + indirect [kg]
	low output [lm] / [W]	high output [lm] / [W]	low output [lm] / [W]	high output [lm] / [W]	low output [lm] / [W]	high output [lm] / [W]	low output [lm] / [W]	high output [lm] / [W]		
straight, L 980	1.222 / 11,2	2.094 / 18,1	1.257 / 11,2	2.153 / 18,1	1.850 / 15,1	3.171 / 24,5	1.885 / 15,1	3.230 / 24,5	2,5	2,7
straight, L 1.960	2.554 / 23,3	4.377 / 37,8	2.626 / 23,3	4.377 / 37,8	3.701 / 31,6	6.343 / 51,1	3.780 / 31,6	6.479 / 51,1	5,1	5,4
90°, R 585	1.224 / 9,6	2.096 / 16,6	1.256 / 11,2	2.156 / 16,6	1.850 / 13,8	3.171 / 23,8	1.885 / 13,8	3.230 / 23,8	2,5	2,6
90°, R 762,5	1.530 / 12,8	2.620 / 21,7	1.570 / 14,0	2.695 / 21,7	2.315 / 18,0	3.965 / 30,5	2.355 / 18,0	4.035 / 30,5	3,2	3,4
90°, R 985	1.836 / 16,3	3.144 / 29,6	1.884 / 16,8	3.234 / 29,6	2.778 / 23,3	4.758 / 40,4	2.826 / 23,3	4.842 / 40,4	4,1	4,4
45°, R 1.272,5	1.224 / 10,6	2.096 / 18,5	1.256 / 11,2	2.156 / 18,5	1.850 / 14,9	3.171 / 25,9	1.885 / 14,9	3.230 / 25,9	2,6	2,8
90°, R 1.272,5	2.448 / 21,3	4.192 / 37,0	2.512 / 22,4	4.312 / 37,0	3.704 / 29,7	6.344 / 51,9	3.768 / 29,7	6.456 / 51,9	5,3	5,6
60°, R 1.520	1.836 / 16,3	3.144 / 29,6	1.884 / 16,8	3.234 / 29,6	2.778 / 23,9	4.758 / 41,7	2.826 / 23,9	4.842 / 41,7	4,2	4,5
90°, R 1.520	3.060 / 25,6	5.240 / 44,5	3.140 / 28,0	5.390 / 44,5	4.630 / 35,8	7.930 / 62,5	4.710 / 35,8	8.070 / 62,5	6,3	6,7
60°, R 1.742,5	2.142 / 20,1	3.668 / 34,8	2.198 / 19,6	3.773 / 34,8	3.241 / 27,4	5.551 / 47,8	3.297 / 27,4	5.649 / 47,8	4,8	5,1
60°, R 2.010	2.754 / 22,8	4.716 / 39,7	2.826 / 25,2	4.851 / 39,7	4.167 / 31,1	7.137 / 54,3	4.239 / 31,1	7.263 / 54,3	5,5	5,9
45°, R 2.500	2.448 / 21,5	4.192 / 37,2	2.512 / 22,4	4.312 / 37,2	3.704 / 29,8	6.344 / 51,8	3.768 / 29,8	6.456 / 51,8	5,1	5,5
40°, R 3.012,5	2.754 / 22,8	4.716 / 39,7	2.826 / 25,2	4.851 / 39,7	4.167 / 31,1	7.137 / 54,3	4.239 / 31,1	7.263 / 54,3	5,5	5,8

Alle Lumenangaben für 4000K, CRI>80, Gehäusefarbe weiß
 All lumen values for 4000K, CRI>80, housing colour white
 Toutes les données de lumens pour 4000K, CRI>80, couleur du boîtier blanc

OVOID50

HÄNGELEUCHE | PENDANT LUMINAIRE | LUMINAIRE SUSPENSION



LED-Hängeleuchte OVOID50 als oval-förmige Standardleuchte. Direktstrahlend. Lichtkanal aus gerolltem Aluminiumprofil mit einer Breite von 50 mm. Ovale Standardleuchte erhältlich mit den Abmessungen 1.160 mm x 850 mm oder 2.500 mm x 1.800mm. Oberfläche der Leuchte feinstruktur matt pulverbeschichtet ähnlich RAL 9016 weiß, RAL 9006 silber oder RAL 9005 schwarz – auf Anfrage in RAL nach Wahl. Diffusor wahlweise in PMMA opal oder PMMA mit mikroprismatischer Prägung für eine reduzierte Leuchtdichte (UGR<19). Leuchte inkl. weißem, rundem Baldachin mit transparentem Einspeisekabel sowie flexiblen Seilabhängern und Schnellspannern zur stufenlosen Regulierung der Montagehöhe. Der LED-Treiber ist im Leuchtgehäuse integriert – wahlweise als on/off oder DALI-Variante. Farbtemperaturen 2700K, 3000K, 4000K oder dynamisch Weiß (2700K–6500K) – Farbwiedergabe CRI>80 oder CRI>90 – Mac Adam ≤3. Weitere Steuerungsoptionen oder Lichtfarben auf Anfrage erhältlich. Außerdem ist die Integration vieler Komponenten, wie beispielsweise Notlicht oder Sensortechnologie, sowie eine Vielzahl weiterer Optionen möglich.

Pendant LED luminaire in an oval-shaped standard design. Direct beam. Light channel made of rolled aluminium profile with a width of 50 mm. Oval standard luminaire available in dimensions 1.160 mm x 850 mm or 2.500 mm x 1.800 mm. Surface of the luminaire fine structure matt powder coated similar to RAL 9016 white, RAL 9006 silver or RAL 9005 black - on request in RAL of choice. Diffuser either in PMMA opal or PMMA clear with microprismatic pattern for reduced luminance (UGR<19). Luminaire incl. white, round canopy with transparent feeding cable as well as flexible cord suspension and quick-release clamps for continuous adjustment of mounting height. The LED driver is integrated in the luminaire housing - either as on/off or DALI version. Colour temperatures 2700K, 3000K, 4000K or dynamic white (2700K-6500K) - colour rendering CRI>80 or CRI>90 - Mac Adam ≤3. Further control options or light colours available on request. In addition, the integration of many components, such as emergency lighting or sensor technology, as well as a variety of other options is possible.

Luminaire LED suspendu au design standard en forme ovale. Éclairage direct de la surface. Luminaire standard ovale disponible dans les dimensions 1.160 mm x 850 mm ou 2.500 mm x 1.800 mm. Surface du luminaire à structure fine matte revêtue par poudre similaire à RAL 9016 blanc, RAL 9006 argent ou RAL 9005 noir - sur demande en RAL au choix. Diffuseur au choix en PMMA opale ou en PMMA transparent avec gaufrage microprismatique pour un éblouissement réduit (UGR<19). Luminaire rond blanc avec un câble d'alimentation transparent ainsi que des câbles flexibles et des tendeurs rapides permettant de régler la hauteur de montage en continu. Le driver LED est intégré dans le boîtier du luminaire - au choix en version on/ off ou DALI. Températures de couleur 2700K, 3000K, 4000K ou blanc dynamique (2700K-6500K) - Rendu des couleurs CRI>80 ou CRI>90 - Mac Adam ≤3. Autres options de commande ou couleurs de lumière disponibles sur demande. En

ÜBERSICHT | OVERVIEW | VUE D'ENSEMBLE

TECHNICAL DATA

2700K / 3000K / 4000K / 2700-6500K

CRI>80 / CRI>90

MacAdam ≤ 3

up to 120 lm/W

on-off / DALI

direct / direct + indirect

opal / microprism (UGR <19)

L80 B10 50.000h

HOUSING COLOUR

schwarz | black | noir
RAL 9005

silber | silver | argent
RAL 9006

weiß | white | blanc
RAL 9016



RAL colour of your choice



Integration of emergency light



Design Cables



Contact us for more options...

HÄNGELEUCHTE „OVOID50“

PENDANT LUMINAIRE "OVOID50"

LUMINAIRE SUSPENSION « OVOID50 »

Bestellbeispiel | Example order | Exemple de commande

1160x850 mm, CRI90, 4000K, direct/indirect, low output on/off, black, microprism

OV50H-119402-LOBLM

1 2 3 4 5 6 7

1	GRÖSSE SIZE TAILLE	
	L 1160 mm, W 850 mm	11
	L 2500 mm, W 1800 mm	25

2	FARBWIEDERGABE COLOUR RENDERING RENDU DES COULEURS	
	CRI>80	8
	CRI>90	9

3	FARBTEMPERATUR COLOUR TEMPERATURE TEMPÉRATURE DE COULEUR	
	2700K (CRI>90 only)	27
	3000K	30
	4000K	40
	2700-6500K (CRI>90 only)	DW

4	LICHTVERTEILUNG LIGHT DISTRIBUTION DISTRIBUTION DE LA LUMIÈRE	
	direct	1
	direct + indirect	2

5	LEISTUNG & STEUERUNG OUTPUT & CONTROL SORTIE & CONTRÔLE	
	low output on/off	LO
	low output DALI	LD
	high output on/off	HO
	high output DALI	HD
	dynamic white DALI DT8	DW

6	GEHÄUSEFARBE HOUSING COLOUR COULEUR DU BOÎTIER	
	silver RAL 9006	SI
	white RAL 9016	WH
	black RAL 9005	BL

7	ABDECKUNG COVER COUVERTURE	
	opal	O
	microprism	M

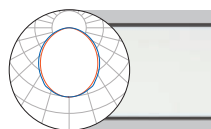
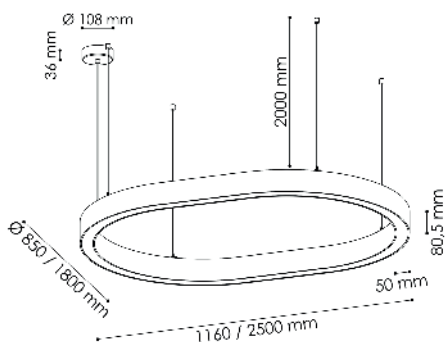

opal direct

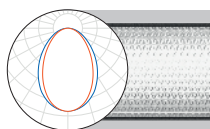

microprism direct

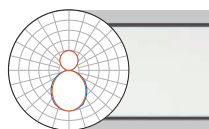

opal direct + indirect

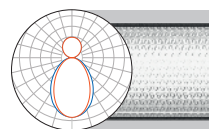

microprism direct + indirect

Size [mm]	opal direct		microprism direct		opal direct + indirect		microprism direct + indirect		direct	direct + indirect
	low output [lm] / [W]	high output [lm] / [W]	low output [lm] / [W]	high output [lm] / [W]	low output [lm] / [W]	high output [lm] / [W]	low output [lm] / [W]	high output [lm] / [W]	KG	KG
1.160 x 850	3.455 / 32,5	5.527 / 57,0	3.656 / 32,5	5.899 / 57,0	7.692 / 65,6	13.758 / 122,1	7.893 / 65,6	14.129 / 122,1	8,3	8,8
2.500 x 1.800	7.539 / 71,0	12.060 / 124,4	7.977 / 71,0	12.869 / 124,4	16.782 / 143,4	30.017 / 266,4	17.220 / 143,4	30.827 / 266,4	17,7	18,8

Alle Lumenangaben für 4000K, CRI>80, Gehäusefarbe weiß

All lumen values for 4000K, CRI>80, housing colour white

Toutes les données de lumens pour 4000K, CRI>80, couleur du boîtier blanc

ROUND90

HÄNGELEUCHE | PENDANT LUMINAIRE | LUMINAIRE SUSPENSION



Runde LED-Flächenleuchte zur Hängemontage. Direktstrahlend oder direkt-indirektstrahlend. Gehäuse aus gerolltem Aluminiumprofil, nahtlos verschweißt. Fertigung der Leuchte in vier Durchmessern: 350, 450, 650 und 950 mm mit einer Gesamthöhe von 90 mm. Oberfläche pulverbeschichtet feinstruktur matt ähnlich RAL 9016 weiß, RAL 9006 silber oder RAL 9005 schwarz – auf Anfrage in RAL nach Wahl. Die durchdachte Konstruktion der Leuchte ermöglicht ein Design in zahlreichen Farbkombinationen – zwischen Gehäusefarbe und Dekorring kann beliebig kombiniert werden. Um der Leuchtenfamilie neben den Standardfarben einen dekorativen Touch zu verleihen, steht der Dekorring auch in den strukturierten Spezialoberflächen schlaggold, schlagsilber und schlagbronze zur Auswahl. Diffusor in PMMA wahlweise opal, mikroprismatisch inkl. Streufolie oder nur mikroprismatisch (office special) für eine reduzierte Leuchtdichte (UGR<19). Leuchte inkl. weißem, rundem Deckenbaldachin mit transparentem Einspeisekabel. Abhängung wählbar zwischen einem individuell kürzbaren starren Pendenrohr (R) oder den 3 Seilabhängungen Standard (H), Zentral (Z) oder Y-Abhängung (Y). Schnellspanner bei den Seilvarianten an der Leuchte zur stufenlosen Regulierung der Montagehöhe. Pendenrohr und dazugehöriger Baldachin in Gehäusefarbe. Der LED-Treiber ist im Leuchtegehäuse integriert – wahlweise als on/off oder DALI-Variante. Farbtemperaturen 2700K, 3000K, 4000K oder dynamisch Weiß (2700K-6500K) – Farbwiedergabe CRI>80 oder CRI>90 – Mac Adam ≤3. Weitere Steuerungsoptionen oder Lichtfarben auf Anfrage möglich. Außerdem ist die Integration vieler Komponenten, wie beispielsweise Notlicht oder Sensortechnologie, sowie eine Vielzahl weiterer Optionen möglich.

Round LED luminaire for pendant mounting. Direct beam or direct-indirect beam. Housing made of rolled aluminium profile, seamlessly welded. Luminaire manufactured in four diameters: 350, 450, 650 and 950 mm with a total height of 90 mm. Surface powder coated fine structure matt similar to RAL 9016 white, RAL 9006 silver or RAL 9005 black - on request in RAL of choice. The sophisticated construction of the luminaire allows a design in numerous colour combinations - any combination of housing colour and decorative ring is possible. To give the luminaire family a decorative touch in addition to the standard colours, the decorative ring is also available in the special textured surfaces beaten gold, beaten silver and beaten bronze. Diffuser in PMMA either opal, microprism incl. diffuser foil or only microprism (office special) for reduced luminance (UGR<19). Luminaire incl. white, round ceiling canopy with transparent feeding cable. Suspension can be selected between an individually shortenable stiff suspension rod (R) or the 3 wire suspensions standard (H), central (Z) or Y-suspension (Y). Quick-release clamps on the cable versions on the luminaire for infinitely variable adjustment of the mounting height. Suspension rod and matching canopy in the same colour as the housing. The LED driver is integrated in the luminaire housing - either as on/off or DALI version. Colour temperatures 2700K, 3000K, 4000K or dynamic white (2700K-6500K) - colour rendering CRI>80 or CRI>90 - Mac Adam ≤3. Further control options or light colours available on request. In addition, the integration of many components, such as emergency lighting or sensor technology, as well as a variety of other options is possible.

Suspension runde LED. Éclairage direct ou éclairage direct-indirect. Boîtier en profilé d'aluminium roulé, soudé sans soudure. Fabrication du luminaire en quatre diamètres : 350, 450, 650 et 950 mm avec une hauteur totale de 90 mm. Surface revêtue par poudre à structure fine mate similaire à RAL 9016 blanc, RAL 9006 argent ou RAL 9005 noir - sur demande en RAL au choix. La construction bien pensée du luminaire permet un design dans de nombreuses combinaisons de couleurs - il est possible de combiner à volonté entre la couleur du boîtier et l'anneau décoratif. Pour donner à la famille de luminaires une touche décorative en plus des couleurs standard, l'anneau décoratif est également disponible dans les surfaces spéciales structurées or choc, argent choc et bronze choc. Diffuseur en PMMA au choix opale, microprismatique y compris feuille diffusante ou uniquement microprismatique (office special) pour un éblouissement réduit (UGR<19). de plafond rond blanc avec câble d'alimentation transparent. Suspension au choix entre un tube de rigide pouvant être raccourci individuellement (R) ou par câble : standard (H), centrale (Z) ou en Y (Y). Tendeur rapide pour les variantes de câble sur le luminaire pour un réglage en continu de la hauteur de montage. Tube de suspension correspondant à la couleur du boîtier. Le driver LED est intégré dans le boîtier du luminaire - au choix en version on/off ou DALI. Températures de couleur 2700K, 3000K, 4000K ou blanc dynamique (2700K-6500K) - Rendu des couleurs CRI>80 ou CRI>90 - Mac Adam ≤3. Autres options de commande ou couleurs de lumière possibles sur demande. En outre, l'intégration de nombreux composants, tels que l'éclairage.

ÜBERSICHT | OVERVIEW | VUE D'ENSEMBLE

TECHNICAL DATA	
2700K / 3000K / 4000K / 2700-6500K	
CRI>80 / CRI>90	
MacAdam ≤ 3	
up to 174 lm/W	
on-off / DALI	
direct / direct + indirect	
opal / microprism / office special (UGR <19)	
L80 B10 50.000h	
HOUSING COLOUR	
schwarz black noir RAL 9005	
silber silver argent RAL 9006	
weiß white blanc RAL 9016	

RAL colour of your choice	Integration of Multisensor	Integration of emergency light	Design Cables	Contact us for more options...			
DECORATION RING COLOUR							
silber hochglanz silver specular argenté brillant		gold hochglanz gold specular doré brillant					
silber matt silver matt argenté mat		bronze hochglanz bronze specular bronze brillant					
schwarz hochglanz black specular noir brillant		titan hochglanz titan specular titan brillant					

HÄNGELEUCHE „ROUND90“
 PENDANT LUMINAIRE “ROUND90”
 LUMINAIRE SUSPENSION « ROUND90 »

Bestellbeispiel | Example order | Exemple de commande

Y-Suspension, 350 mm, CRI>90, 4000K, direct, low output on/off, black, beaten gold, microprism

RO90Y-359401-LOBGM

1 2 3 4 5 6 7 8 9

1	ABHÄNGUNG SUSPENSION SUSPENSION	
	Standard	H
	Central	Z
	Y-Suspension	Y
	Rod Suspension	R
2	DURCHMESSER DIAMETER DIAMÈTRE	
	350 mm	35
	450 mm	45
	650 mm	65
	950 mm	95
3	FARBWIEDERGABE COLOUR RENDERING RENDU DES COULEURS	
	CRI>80	8
	CRI>90	9

4	FARBTEMPERATUR COLOUR TEMPERATURE TEMPÉRATURE DE COULEUR	
	2700K (CRI>90 only)	27
	3000K	30
	4000K	40
	2700-6500K (CRI>90 only)	DW
5	LICHTVERTEILUNG LIGHT DISTRIBUTION DISTRIBUTION DE LA LUMIÈRE	
	direct	1
	direct + indirect	2
6	LEISTUNG & STEUERUNG OUTPUT & CONTROL SORTIE & CONTRÔLE	
	low output on/off	LO
	low output DALI	LD
	high output on/off	HO
	high output DALI	HD
	dynamic white DALI DT8	DW

7	GEHÄUSEFARBE HOUSING COLOUR COULEUR DU BOÎTIER	
	black RAL 9005	B
	silver RAL 9006	S
	white RAL 9016	W
8	DEKORRING FARBE DECORATION RING COLOUR BAGUE DÉCORATIVE COULEUR	
	black RAL 9005	B
	silver RAL 9006	S
	white RAL 9016	W
	beaten gold	G
	beaten silver	A
	beaten bronze	C
9	DIFFUSOR DIFFUSER DIFFUSEUR	
	opal	O
	microprism	M
	office special	B

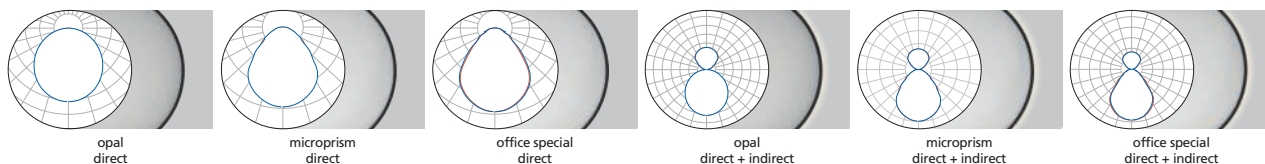
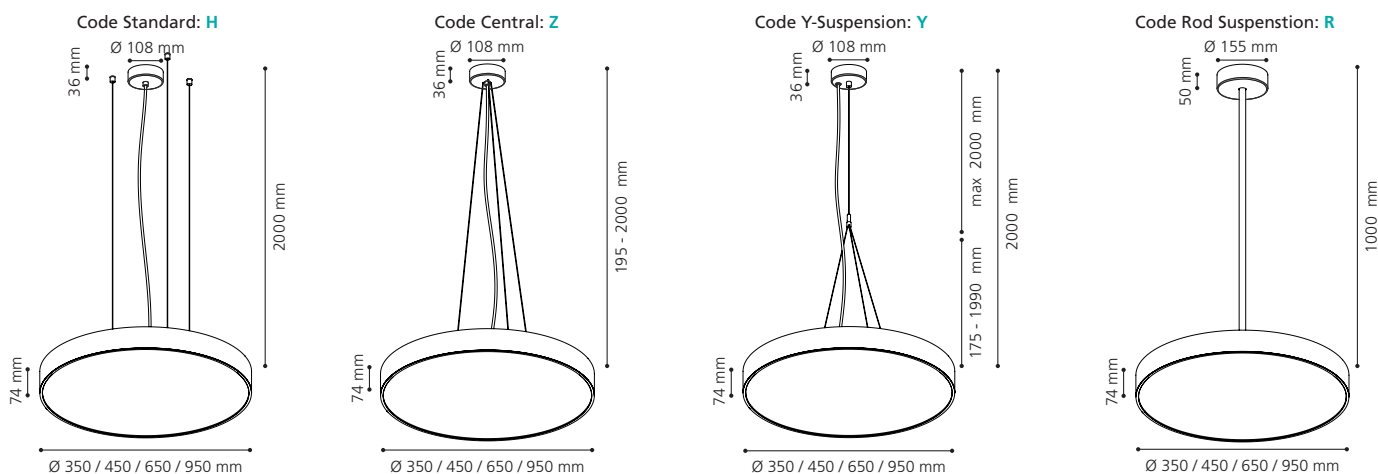

Size [mm]	low output [lm] / [W]		high output [lm] / [W]		low output [lm] / [W]		high output [lm] / [W]		low output [lm] / [W]		high output [lm] / [W]		KG
	low output [lm]	high output [lm]	low output [lm]	high output [lm]	low output [lm]	high output [lm]	low output [lm]	high output [lm]	low output [lm]	high output [lm]			
Ø 350	1.158 / 8,5	1.826 / 12,9	1.077 / 8,5	1.697 / 12,9	1.213 / 8,5	1.905 / 12,9	1.747 / 11,9	2.625 / 17,5	1.661 / 11,9	2.493 / 17,5	1.795 / 11,9	2.691 / 17,5	3,8
Ø 450	2.258 / 15,5	3.561 / 23,5	2.099 / 15,5	3.309 / 23,5	2.364 / 15,5	3.715 / 23,5	3.207 / 20,7	4.820 / 30,3	3.050 / 20,7	4.577 / 30,2	3.296 / 20,7	4.942 / 30,3	5,0
Ø 650	4.114 / 27,2	6.489 / 41,3	3.825 / 27,2	6.029 / 41,3	4.309 / 27,2	6.770 / 41,3	5.534 / 35,2	8.317 / 51,3	5.263 / 35,2	7.897 / 51,3	5.687 / 35,2	8.526 / 51,3	8,0
Ø 950	9.102 / 56,7	14.360 / 86,0	8.466 / 56,7	13.342 / 86,0	9.535 / 56,7	14.982 / 86,0	11.036 / 67,7	16.585 / 99,1	10.494 / 67,7	15.748 / 99,1	11.342 / 67,7	17.004 / 99,1	19,5

Alle Lumenangaben für 4000K, CRI>80, Gehäusefarbe weiß
 All lumen values for 4000K, CRI>80, housing colour white
 Toutes les données de lumens pour 4000K, CRI>80, couleur du boîtier blanc

SQUARE90

HÄNGELEUCHTE | PENDANT LUMINAIRE | LUMINAIRE SUSPENSION



Quadratische LED-Flächenleuchte zur Hängemontage. Direktstrahlend oder direkt-indirektstrahlend. Gehäuse aus Aluminiumprofil, nahtlos verschweißt. Fertigung der Leuchte in vier Größen: 350, 450, 650 und 950 mm mit einer Gesamthöhe von 90 mm. Oberfläche pulverbeschichtet feinstruktur matt ähnlich RAL 9016 weiß, RAL 9006 silber oder RAL 9005 schwarz – auf Anfrage in RAL nach Wahl. Die durchdachte Konstruktion der Leuchte ermöglicht ein Design in zahlreichen Farbkombinationen – zwischen Gehäusefarbe und Dekorring kann beliebig kombiniert werden. Um der Leuchtenfamilie neben den Standardfarben einen dekorativen Touch zu verleihen, steht der Dekorring auch in den strukturierten Spezialoberflächen schlaggold, schlagsilber und schlagbronze zur Auswahl. Diffusor in PMMA wahlweise opal, mikroprismatisch inkl. Streufolie oder nur mikroprismatisch (office special) für eine reduzierte Leuchtdichte (UGR<19). Leuchte inkl. weißem, rundem Deckenbaldachin mit transparentem Einspeisekabel. Abhängung wählbar zwischen einem individuell kürzbaren starren Pendelrohr (R) oder den 3 Seilabhängungen Standard (H), Zentral (Z) oder Y-Abhängung (Y). Schnellspanner bei den Seilvarianten an der Leuchte zur stufenlosen Regulierung der Montagehöhe. Pendelrohr und dazugehöriger Baldachin in Gehäusefarbe. Der LED-Treiber ist im Leuchtgehäuse integriert – wahlweise als on/off oder DALI-Variante. Farbtemperaturen 2700K, 3000K, 4000K oder dynamisch Weiß (2700K–6500K) – Farbwiedergabe CRI>80 oder CRI>90 – Mac Adam ≤3. Weitere Steuerungsoptionen oder Lichtfarben auf Anfrage möglich. Außerdem ist die Integration vieler Komponenten, wie beispielsweise Notlicht oder Sensortechnologie, sowie eine Vielzahl weiterer Optionen möglich.

Square LED luminaire for pendant mounting. Direct beam or direct-indirect beam. Housing made of aluminium profile, seamlessly welded. Luminaire manufactured in four sizes: 350, 450, 650 and 950 mm with a total height of 90 mm. Surface powder coated fine structure matt similar to RAL 9016 white, RAL 9006 silver or RAL 9005 black - on request in RAL of choice. The sophisticated construction of the luminaire allows a design in numerous colour combinations - any combination of housing colour and decorative ring is possible. To give the luminaire family a decorative touch in addition to the standard colours, the decorative ring is also available in the special textured surfaces of beaten gold, beaten silver and beaten bronze. Diffuser in PMMA either opal, microprism incl. diffuser foil or only microprism (office special) for reduced luminance (UGR<19). Luminaire incl. white, round ceiling canopy with transparent feeding cable. Suspension can be selected between an individually shortenable stiff suspension rod (R) or the 3 wire suspensions standard (H), central (Z) or Y-suspension (Y). Quick-release clamps on the cable versions on the luminaire for infinitely variable adjustment of the mounting height. Suspension rod and matching canopy in the same colour as the housing. The LED driver is integrated in the luminaire housing - either as on/off or DALI version. Colour temperatures 2700K, 3000K, 4000K or dynamic white (2700K-6500K) - colour rendering CRI>80 or CRI>90 - Mac Adam ≤3. Further control options or light colours available on request. In addition, the integration of many components, such as emergency lighting or sensor technology, as well as a variety of other options is possible.

Suspension carrée LED. Éclairage direct ou direct-indirect. Boîtier en profilé d'aluminium, soudé sans soudure. Fabrication du luminaire en quatre dimensions : 350, 450, 650 et 950 mm avec une hauteur totale de 90 mm. Surface revêtue par poudre à structure fine mate similaire à RAL 9016 blanc, RAL 9006 argent ou RAL 9005 noir - sur demande en RAL au choix. La construction bien pensée du luminaire permet un design dans de nombreuses combinaisons de couleurs - il est possible de combiner à volonté entre la couleur du boîtier et l'anneau décoratif. Pour donner à la famille de luminaires une touche décorative en plus des couleurs standard, l'anneau décoratif est également disponible dans les surfaces spéciales structurées or choc, argent choc et bronze choc. Diffuseur en PMMA au choix opale, microprismatique y compris feuille diffuseuse ou uniquement microprismatique (office special) pour un éblouissement réduit (UGR<19). Luminaire de plafond rond blanc avec câble d'alimentation transparent. Suspension au choix entre un tube rigide pouvant être raccourci individuellement (R) ou par câble : standard (H), centrale (Z) ou en Y (Y). Tendeur rapide pour les variantes de câble sur le luminaire pour un réglage en continu de la hauteur de montage. Tube de suspension correspondant dans la couleur du boîtier. Le driver LED est intégré dans le boîtier du luminaire - au choix en version on/off ou DALI. Températures de couleur 2700K, 3000K, 4000K ou blanc dynamique (2700K-6500K) - Rendu des couleurs CRI>80 ou CRI>90 - Mac Adam ≤3. Autres options de commande ou couleurs de lumière possibles sur demande. En outre, l'intégration de nombreux composants, tels que l'éclairage de secours ou la technologie des capteurs, une multitude d'autres options sont possibles.

ÜBERSICHT | OVERVIEW | VUE D'ENSEMBLE

TECHNICAL DATA	
2700K / 3000K / 4000K / 2700-6500K	
CRI>80 / CRI>90	
MacAdam ≤ 3	
up to 175 lm/W	
on-off / DALI	
direct / direct + indirect	
opal / microprism / office special (UGR <19)	
L80 B10 50.000h	
HOUSING COLOUR	
schwarz black noir RAL 9005	
silber silver argent RAL 9006	
weiß white blanc RAL 9016	

RAL colour of your choice	Integration of Multisensor	Integration of emergency light	Design Cables	Contact us for more options...				
DECORATION RING COLOUR								
schwarz black noir RAL 9005		schlaggold beaten gold or texturés						
silber silver argent RAL 9006		schlagsilber beaten silver argent texturés						
weiß white blanc RAL 9016		schlagbronze beaten bronze bronze texturés						

HÄNGELEUCHTE „SQUARE90“
PENDANT LUMINAIRE “SQUARE90”
LUMINAIRE SUSPENSION « SQUARE90 »

Bestellbeispiel | Example order | Exemple de commande

Y-Suspension, 350 x 350 mm, CRI>90, 4000K, direct, low output on/off, white, beaten gold, microprism

SQ90Y-359401-LOWGM

1 2 3 4 5 6 7 8 9

1	ABHÄNGUNG SUSPENSION SUSPENSION	
	Standard	H
	Central	Z
	Y-Suspension	Y
	Rod Suspension	R
2	GRÖSSE SIZE TAILLE	
	350 x 350 mm	35
	450 x 450 mm	45
	650 x 650 mm	65
	950 x 950 mm	95
3	FARBWIEDERGABE COLOUR RENDERING RENDU DES COULEURS	
	CRI>80	8
	CRI>90	9

4	FARBTEMPERATUR COLOUR TEMPERATURE TEMPÉRATURE DE COULEUR	
	2700K (CRI>90 only)	27
	3000K	30
	4000K	40
	2700-6500K (CRI>90 only)	DW
5	LICHTVERTEILUNG LIGHT DISTRIBUTION DISTRIBUTION DE LA LUMIÈRE	
	direct	1
	direct + indirect	2
6	LEISTUNG & STEUERUNG OUTPUT & CONTROL SORTIE & CONTRÔLE	
	low output on/off	LO
	low output DALI	LD
	high output on/off	HO
	high output DALI	HD
	dynamic white DALI DT8	DW

7	GEHÄUSEFARBE HOUSING COLOUR COULEUR DU BOÎTIER	
	black RAL 9005	B
	silver RAL 9006	S
	white RAL 9016	W
8	DEKORRING FARBE DECORATION RING COLOUR BAGUE DÉCORATIVE COULEUR	
	black RAL 9005	B
	silver RAL 9006	S
	white RAL 9016	W
	beaten gold	G
	beaten silver	A
	beaten bronze	C
9	DIFFUSOR DIFFUSER DIFFUSEUR	
	opal	O
	microprism	M
	office special	B

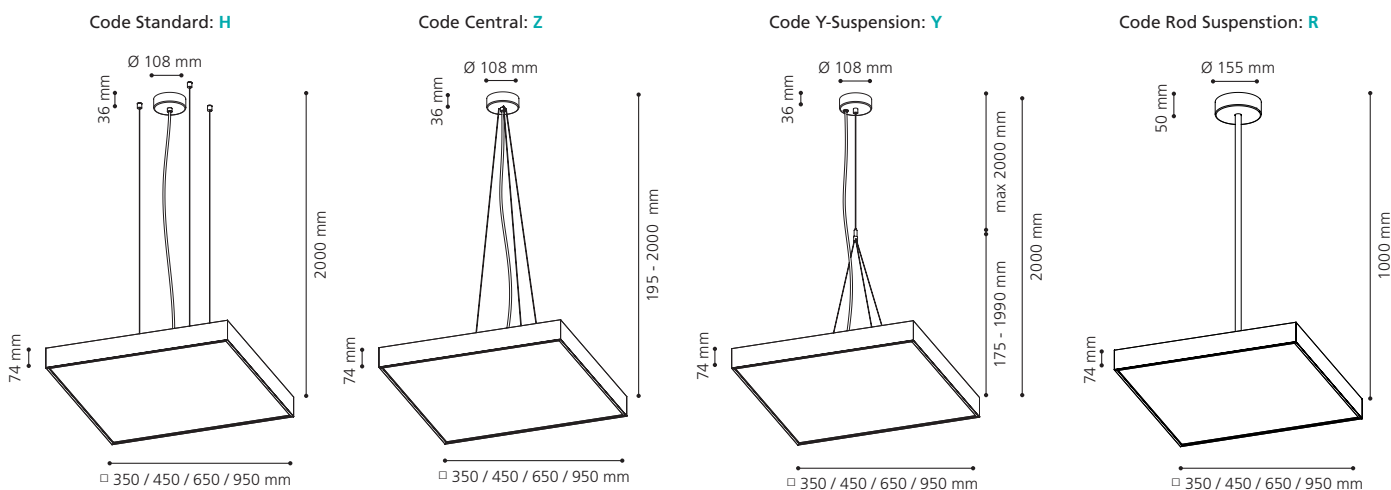

Size [mm]	opal direct		microprism direct		office special direct		opal direct + indirect		microprism direct + indirect		office special direct + indirect		kg
	low output [lm] / [W]	high output [lm] / [W]	low output [lm] / [W]	high output [lm] / [W]	low output [lm] / [W]	high output [lm] / [W]	low output [lm] / [W]	high output [lm] / [W]	low output [lm] / [W]	high output [lm] / [W]	low output [lm] / [W]	high output [lm] / [W]	
□ 350	1.349 / 9,9	2.365 / 16,7	1.256 / 9,9	2.208 / 16,7	1.402 / 9,9	2.470 / 16,7	2.029 / 13,8	3.488 / 23,1	1.923 / 13,8	3.308 / 23,1	2.081 / 13,8	3.579 / 23,1	4,4
□ 450	2.288 / 15,4	4.011 / 25,9	2.130 / 15,4	3.744 / 25,9	2.377 / 15,4	4.189 / 25,9	3.236 / 20,7	5.563 / 34,6	3.067 / 20,7	5.276 / 34,6	3.319 / 20,7	5.709 / 34,6	5,8
□ 650	4.711 / 30,5	8.258 / 51,6	4.385 / 30,5	7.708 / 51,6	4.894 / 30,5	8.624 / 51,6	5.845 / 37,0	10.048 / 61,8	5.845 / 37,0	9.530 / 61,8	5.995 / 37,0	10.312 / 61,8	9,8
□ 950	9.868 / 60,9	17.299 / 102,8	9.187 / 60,9	16.148 / 102,8	10.252 / 60,9	18.067 / 102,8	10.918 / 67,4	18.770 / 112,6	10.348 / 67,4	17.801 / 112,6	11.198 / 67,4	19.262 / 112,6	23,9

Alle Lumenangaben für 4000K, CRI>80, Gehäusefarbe weiß

All lumen values for 4000K, CRI>80, housing colour white

Toutes les données de lumens pour 4000K, CRI>80, couleur du boîtier blanc

ROPE22

HÄNGELEUCHE | PENDANT LUMINAIRE | LUMINAIRE SUSPENSION

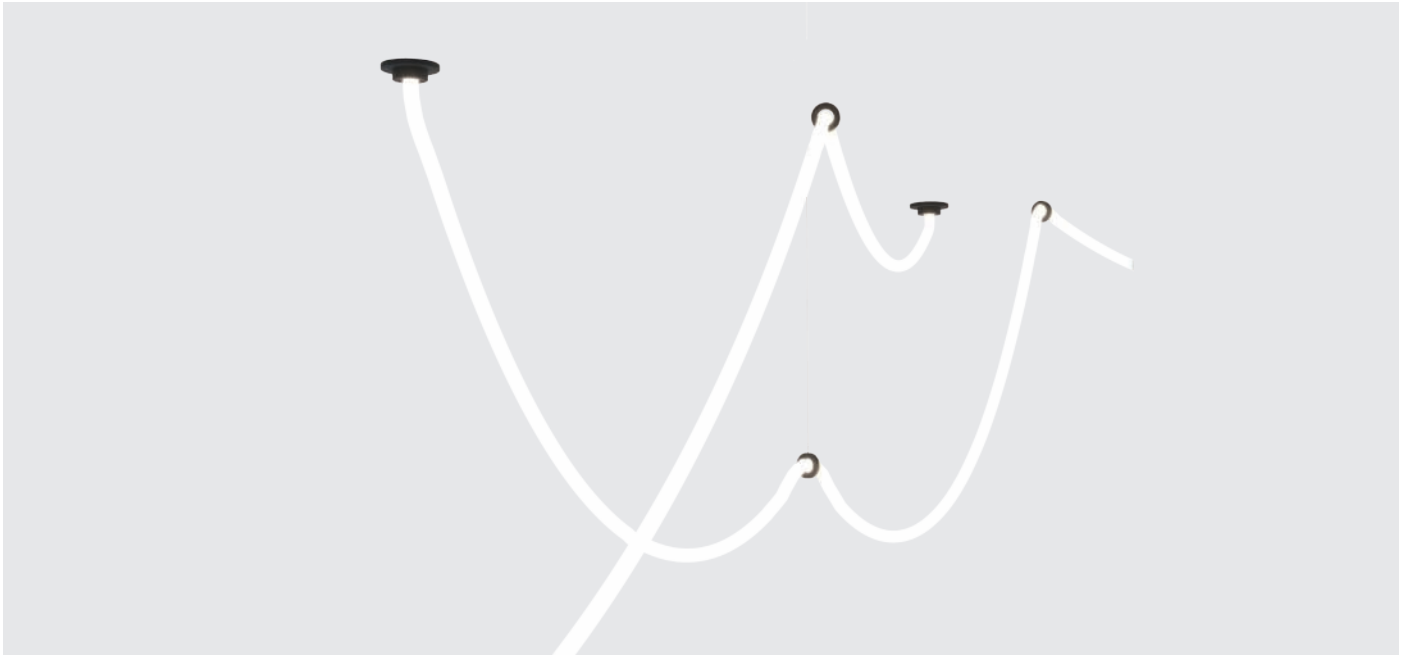

LED Hängeleuchte mit 360° Abstrahlcharakteristik. Lichtschlauch aus lebensmittelechtem Silikon mit einem Durchmesser von 22mm. Der Lichtschlauch ist erhältlich in verschiedenen Standardlängen von 1.200mm bis 10.000mm. Die Produktfamilie ROPE22 beinhaltet verschiedenstes Montagezubehör zur Aufbau-, Einbau-, und Pendelmontage. Die Zubehörteile sind in den feinstruktur matt pulverbeschichteten Standardfarben schwarz ähnlich RAL 9005 sowie weiß ähnlich RAL 9016 erhältlich – zusätzlich erhältlich sind alle Teile in eloxierter Variante mit den Standardfarben: gold, anthrazit oder mitternachtsblau. RAL nach Wahl steht Ihnen auf Anfrage zur Verfügung. Sämtliches Pendelzubehör wird mit Seilabhängungen zur stufenlosen Regulierung der Montagehöhe geliefert. Der LED-Treiber ist im Aufbaubaldachin integriert oder als Decken-Einwurf Gerät zum Einbaubaldachin integriert - wahlweise als on/off oder DALI-Variante. Farbtemperaturen 2700K, 3000K oder 4000K – Farbwiedergabe CRI>90 - Mac Adam ≤3. Weitere Steuerungsoptionen oder Lichtfarben auf Anfrage erhältlich.

Pendant LED luminaire with 360° beam characteristics. Light tube made of food-grade silicone with a diameter of 22mm. The light tube is available in various standard lengths from 1.200mm to 10.000mm. The ROPE22 product family includes a wide range of mounting accessories for surface, recessed and pendant mounting. The accessories are available in the fine-textured matt powder-coated standard colours black similar to RAL 9005 and similar to white RAL 9016 - all parts are also available in anodised versions with the standard colours: gold, anthracite or midnight blue. RAL colours of your choice are available on request. All pendant accessories are supplied with wire suspensions for infinitely variable adjustment of the mounting height. The LED driver is integrated into the surface-mounted canopy or integrated into the recessed canopy as a throw-in ceiling device - optionally as an on/off or DALI version. Colour temperatures 2700K, 3000K or 4000K - colour rendering CRI>90 - Mac Adam ≤3. Further control options or light colours available on request.

Luminaire LED suspendu avec un faisceau de 360°. Tube lumineux en silicone alimentaire d'un diamètre de 22 mm. Le tube lumineux est disponible en différentes longueurs standard de 1.200 mm à 10.000 mm. La famille de produits ROPE22 comprend une large gamme d'accessoires de montage pour les montages en surface, encastrés et suspendus. Les accessoires sont disponibles dans les couleurs standard noir similaire à RAL 9005 et blanc similaire à RAL 9016, avec un revêtement en poudre mat à texture fine. Toutes les pièces sont également disponibles en version anodisée dans les couleurs standard : or, anthracite ou bleu nuit. Les couleurs RAL de votre choix sont disponibles sur demande. Tous les accessoires suspendus sont livrés avec des suspensions en fil de fer permettant un réglage en continu de la hauteur de montage. Le pilote LED est intégré dans le boîtier en saillie ou dans le boîtier encastré en tant qu'élément de plafond à encastrer - au choix en version marchelarrêt ou DALI. Températures de couleur 2700K, 3000K ou 4000K - rendu des couleurs CRI>90 - Mac Adam ≤3. D'autres options de commande ou couleurs de lumière sont disponibles sur demande.

ÜBERSICHT | OVERVIEW | VUE D'ENSEMBLE

TECHNICAL DATA

2700K / 3000K / 4000K

CRI>90

MacAdam ≤ 3

on-off / DALI

360° light emission

L80 B10 50.000h



RAL colour of your choice



Contact us for more options...

HOUSING COLOUR

schwarz | black | noir
RAL 9005



mitternachtsblau eloxiert | midnight blue anodised | bleu minuit anodisé



gold eloxiert | gold anodised | or anodisé



weiß | white | blanc
RAL 9016



anthrazit eloxiert | anthracite anodised | anthracite anodisé



HÄNGELEUCHTE „ROPE22“
 PENDANT LUMINAIRE “ROPE22”
 LUMINAIRE SUSPENSION « ROPE22 »

ROPE22:

1 LÄNGE LENGTH LONGEUR	
1.200 mm	01
2.500 mm	25
5.000 mm	50
7.500 mm	75
10.000 mm	10

2 FARBTEMPERATUR COLOUR TEMPERATURE TEMPÉRATURE DE COULEUR	
2700K	27
3000K	30
4000K	40

Bestellbeispiel | Example order | Exemple de commande
 10.000 mm, CRI>90, 4000K
6 RP22C-10940
 1 2

ROPE electrical accessories:

1 BESCHREIBUNG DESCRIPTION DESCRIPTION	
power supply surface	PA
power supply recessed	PE

2 LEISTUNG & STEUERUNG OUTPUT & CONTROL SORTIE & CONTRÔLE	
on/off	OO
DALI	DD

3 GEHÄUSEFARBE HOUSING COLOUR COULEUR DU BOÎTIER	
white RAL 9016	WH
black RAL 9005	BL
midnight blue anodised	BA
anthracite anodised	AA
gold anodised	GA

Bestellbeispiel | Example order | Exemple de commande
 power supply surface, DALI, black
6 RP22C-PA-DDBL
 1 2 3

ROPE mechanical accessories:

1 BESCHREIBUNG DESCRIPTION DESCRIPTION	
mounting-set recessed	IE
mounting-set surface	IA
mounting-ring surface	RA
mounting-ring suspended	RH
endcap	EC
surface-endcap	SC

2 GEHÄUSEFARBE HOUSING COLOUR COULEUR DU BOÎTIER	
white RAL 9016	WH
black RAL 9005	BL
midnight blue anodised	BA
anthracite anodised	AA
gold anodised	GA

Bestellbeispiel | Example order | Exemple de commande
 mounting-ring suspended, black
6 RP22C-RH-BL
 1 2

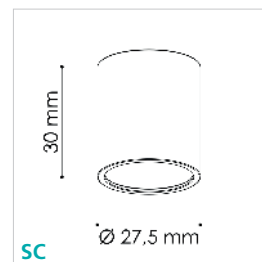
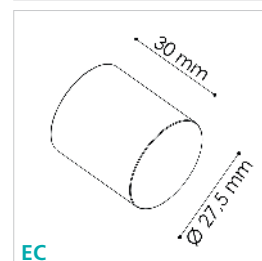
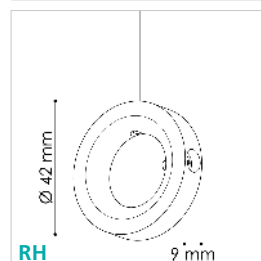
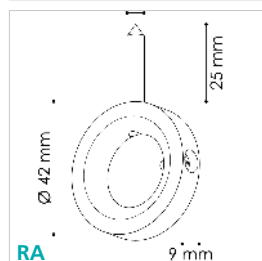
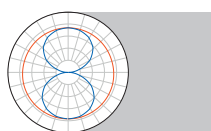
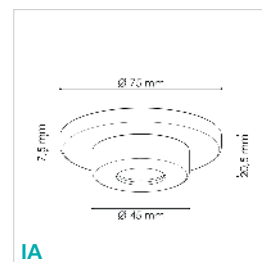
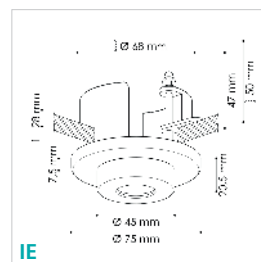
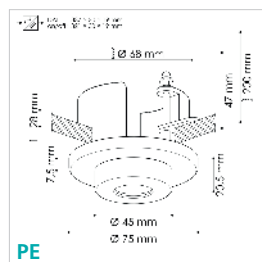
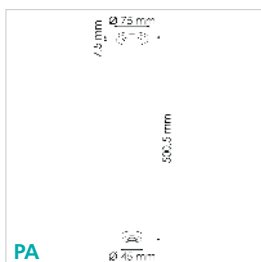
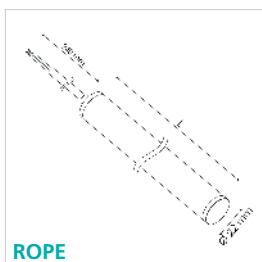

Size [mm]	low output [lm] / [W]	 [kg]
1.200	1.968 / 18,0	0,56
2.500	4.100 / 37,5	1,18
5.000	8.200 / 75,0	2,35
7.500	12.300 / 112,5	3,53
10.000	16.400 / 150,0	4,7

Alle Lumenangaben für 4000K, CRI>90
 All lumen values for 4000K, CRI>90
 Toutes les données de lumens pour 4000K, CRI>90

OVERVIEW

WANDLEUCHTEN | WALL LUMINAIRES | *APPLIQUES MURALES*



LINE40
182



LINE50
184



LINE70
186



ROUND90
188



SQUARE90
190

WANDLEUCHTEN

WALL LUMINAIRES

APPLIQUES MURALES

LINE40

WANDLEUCHTE | WALL LUMINAIRE | APPLIQUE MURALE

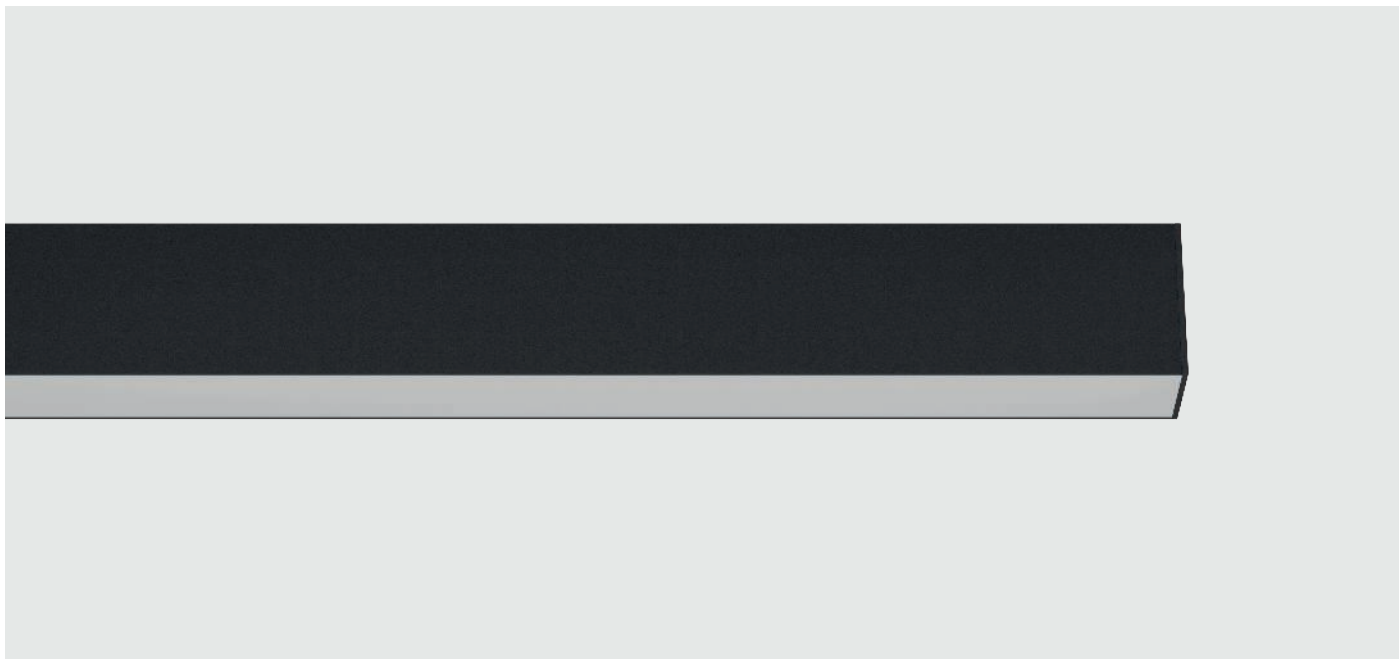

LED-Wandleuchte direktstrahlend oder direkt-indirektstrahlend. Lichtkanal aus Aluminium-Strangpressprofil mit einer Breite von 41 mm. Fertigung der Leuchtenlänge millimetergenau auf Kundenwunsch möglich. Oberfläche der Leuchte feinstruktur matt pulverbeschichtet ähnlich RAL 9016 weiß, RAL 9006 silber oder RAL 9005 schwarz – auf Anfrage in RAL nach Wahl. Diffusor wahlweise in PMMA opal oder PMMA klar mit eingeschobener mikroprismatischer Platte für eine reduzierte Leuchtdichte (UGR<19). Leuchte inkl. speziellem schnellmontage-Wandbaldachin (Montage mittels Stecker und Gegenstecker). Der LED-Treiber ist im Leuchtgehäuse integriert – wahlweise als on/off oder DALI-Variante. Farbtemperaturen 2700K, 3000K, 4000K oder dynamisch Weiß (2700K-6500K) – Farbwiedergabe CRI>80 oder CRI>90 – Mac Adam ≤3. Weitere Steuerungsoptionen oder Lichtfarben auf Anfrage erhältlich. Außerdem ist die Integration vieler Komponenten, wie beispielsweise Notlicht oder Sensortechnologie, sowie eine Vielzahl weiterer Optionen möglich.

Wall-mounted LED luminaire with direct beam or direct-indirect beam. Light channel made of extruded aluminium profile with a width of 41 mm. Luminaire length can be manufactured to the exact millimetre on customer request. Surface of the luminaire fine structure matt powder coated similar to RAL 9016 white, RAL 9006 silver or RAL 9005 black - on request in RAL of choice. Diffuser either in PMMA opal or PMMA clear with inserted microprismatic plate for reduced luminance (UGR<19). Luminaire incl. special quick-mount wall canopy (mounting with plug and counterplug). The LED driver is integrated in the luminaire housing - either as on/off or DALI version. Colour temperatures 2700K, 3000K, 4000K or dynamic white (2700K-6500K) - colour rendering CRI>80 or CRI>90 - Mac Adam ≤3. Further control options or light colours available on request. In addition, the integration of many components, such as emergency lighting or sensor technology, as well as a variety of other options is possible.

Luminaire LED mural à éclairage direct ou direct-indirect. Canal lumineux en profilé d'aluminium extrudé d'une largeur de 41 mm. Fabrication de la longueur du luminaire au millimètre près possible sur demande du client. Surface du luminaire à structure fine, revêtement par poudre mat similaire à RAL 9016 blanc, RAL 9006 argent ou RAL 9005 noir - sur demande en RAL au choix. Diffuseur au choix en PMMA opale ou en PMMA transparent avec plaque microprismatique insérée pour un éblouissement réduit (UGR<19). Luminaire avec A mural spécial à montage rapide (montage au moyen d'une fiche et d'une contre-fiche). Le pilote LED est intégré dans le boîtier du luminaire - au choix sous forme de variante on/off ou DALI. Températures de couleur 2700K, 3000K, 4000K ou blanc dynamique (2700K-6500K) - Rendu des couleurs CRI>80 ou CRI>90 - Mac Adam ≤3. Autres options de commande ou couleurs de lumière disponibles sur demande. En outre, l'intégration de nombreux composants, tels que l'éclairage de secours ou des capteurs, une multitude d'autres options sont possibles.

ÜBERSICHT | OVERVIEW | VUE D'ENSEMBLE

TECHNICAL DATA

2700K / 3000K / 4000K / 2700-6500K

CRI>80 / CRI>90

MacAdam ≤ 3

up to 142 lm/W, up to 6.245 lm/m

on-off / DALI

direct / direct + indirect

opal / microprism (UGR <19)

L80 B10 50.000h

HOUSING COLOUR

schwarz | black | noir
RAL 9005

silber | silver | argent
RAL 9006

weiß | white | blanc
RAL 9016



RAL colour of your choice



Integration of Multisensor



Welded mitre cuts



Integration of emergency light



Contact us for more options...

WANDLEUCHTE „LINE40“
WALL LUMINAIRE “LINE40”
APPLIQUE MURALE « LINE40 »

Bestellbeispiel | Example order | Exemple de commande
 3.132 mm, CRI>90, 4000K, direct + indirect, low output on/off, black, microprism

LI40W-319402-LOBLM

1 2 3 4 5 6 7

1 LÄNGE LENGTH LONGEUR	
612 mm	06
972 mm	09
1.212 mm	12
1.452 mm	14
1.692 mm	16
1.932 mm	19
2.172 mm	21
2.412 mm	24
2.892 mm	28
3.132 mm	31
3.854 mm	38

2 FARBWIEDERGABE COLOUR RENDERING RENDU DES COULEURS	
CRI>80	8
CRI>90	9

3 FARBTEMPERATUR COLOUR TEMPERATURE TEMPÉRATURE DE COULEUR	
2700K (CRI>90 only)	27
3000K	30
4000K	40
2700-6500K (CRI>90 only)	DW

4 LICHTVERTEILUNG LIGHT DISTRIBUTION DISTRIBUTION DE LA LUMIÈRE	
direct	1
direct + indirect	2

5 LEISTUNG & STEUERUNG OUTPUT & CONTROL SORTIE & CONTRÔLE	
low output on/off	LO
low output DALI	LD
high output on/off	HO
high output DALI	HD
dynamic white DALI DT8	DW

6 GEHÄUSEFARBE HOUSING COLOUR COULEUR DU BOÎTIER	
silver RAL 9006	SI
white RAL 9016	WH
black RAL 9005	BL

7 DIFFUSOR DIFFUSER DIFFUSEUR	
opal	O
microprism	M

direct

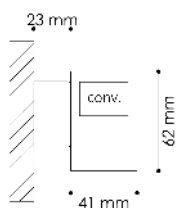

direct + indirect

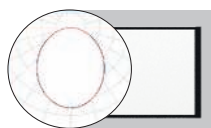
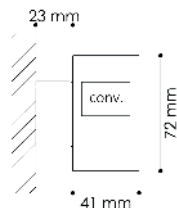

opal direct

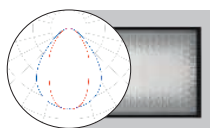

microprism direct

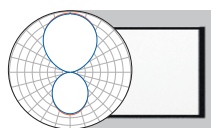

opal direct + indirect

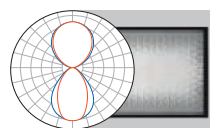

microprism direct + indirect

direct indirect

Size [mm]	opal direct		microprism direct		opal direct + indirect		microprism direct + indirect		direct	indirect
	low output [lm] / [W]	high output [lm] / [W]	low output [lm] / [W]	high output [lm] / [W]	low output [lm] / [W]	high output [lm] / [W]	low output [lm] / [W]	high output [lm] / [W]	kg	kg
612	840 / 8,8	1.495 / 16,3	876 / 8,8	1.560 / 16,3	1.923 / 16,3	3.668 / 30,0	1.962 / 16,3	3.761 / 30,0	1,4	1,7
972	1.324 / 13,0	2.461 / 25,0	1.381 / 13,0	2.567 / 25,0	3.077 / 23,7	5.869 / 46,3	3.139 / 23,7	6.018 / 46,3	2,1	2,8
1.212	1.777 / 16,3	3.150 / 30,0	1.854 / 16,3	3.286 / 30,0	3.845 / 29,1	7.336 / 57,2	3.924 / 29,1	7.522 / 57,2	2,6	3,4
1.452	2.010 / 18,5	3.763 / 35,8	2.097 / 18,5	3.925 / 35,8	4.615 / 34,5	8.803 / 68,1	4.709 / 34,5	9.026 / 68,1	3,2	4,2
1.692	2.398 / 21,2	4.470 / 41,1	2.501 / 21,2	4.663 / 41,1	5.384 / 39,5	10.270 / 80,8	5.494 / 39,5	10.531 / 80,8	3,7	4,8
1.932	2.779 / 23,7	5.222 / 46,3	2.889 / 23,7	5.448 / 46,3	6.154 / 44,6	11.738 / 91,7	6.278 / 44,6	12.035 / 91,7	4,2	5,5
2.172	3.157 / 26,6	5.931 / 52,0	3.293 / 26,6	6.187 / 52,0	6.923 / 50,0	13.205 / 103,0	7.063 / 50,0	13.540 / 103,0	4,7	6,1
2.412	3.441 / 29,2	6.544 / 57,3	3.590 / 29,2	6.826 / 57,3	7.690 / 56,0	14.672 / 113,0	7.848 / 56,0	15.044 / 113,0	5,3	6,8
2.892	3.880 / 34,3	7.570 / 69,6	4.048 / 34,3	7.897 / 69,6	9.230 / 67,0	17.606 / 135,0	9.418 / 67,0	18.053 / 135,0	6,4	8,2
3.132	4.326 / 36,9	8.516 / 75,5	4.513 / 36,9	8.884 / 75,5	9.999 / 72,3	19.074 / 145,3	10.202 / 72,3	19.557 / 145,3	6,8	8,9
3.854	5.558 / 47,4	10.444 / 92,6	5.798 / 47,4	10.896 / 92,6	12.308 / 89,2	23.476 / 183,4	12.556 / 89,2	24.070 / 183,4	8,5	11,1

Alle Lumenangaben für 4000K, CRI>80, Microprisma ohne Opalfolie

All lumen values for 4000K, CRI>80, microprism without opal foil

Toutes les données de lumens pour 4000K, CRI>80, microprisme sans feuille opale

LINE50

WANDLEUCHTE | WALL LUMINAIRE | APPLIQUE MURALE

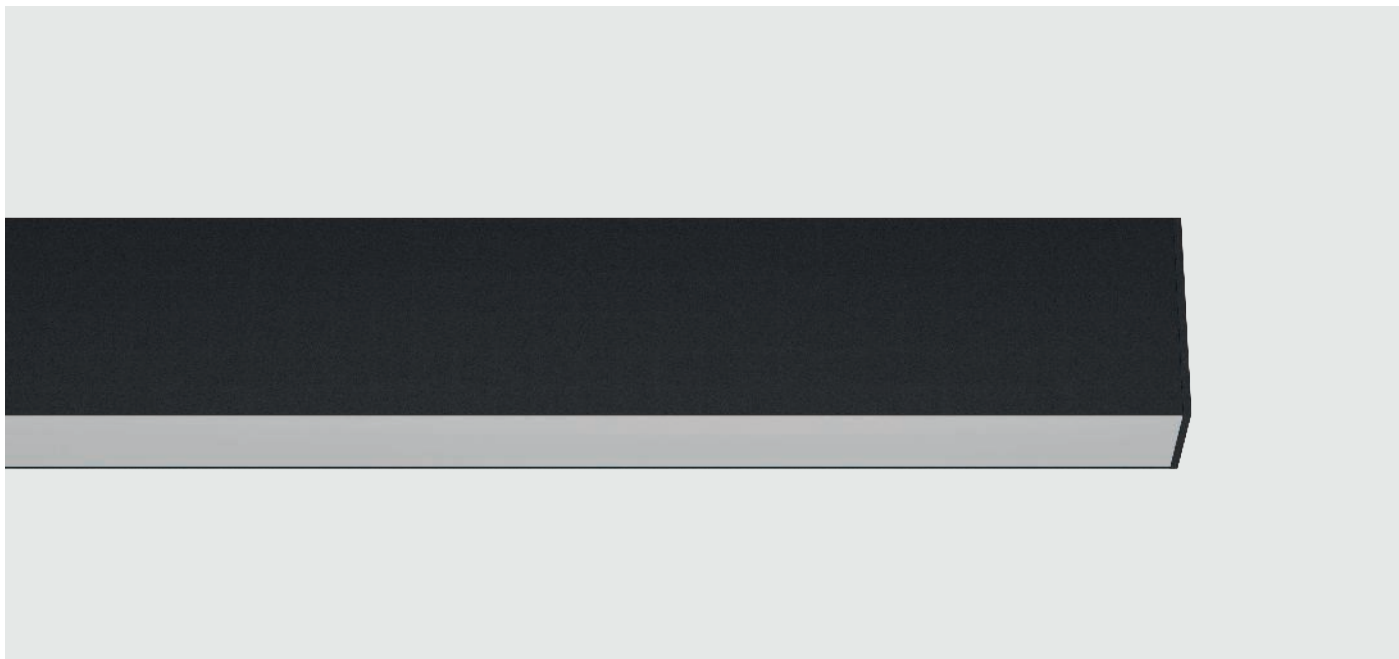

LED-Wandleuchte direktstrahlend oder direkt-indirektstrahlend. Lichtkanal aus Aluminium-Strangpressprofil mit einer Breite von 50 mm. Fertigung der Leuchtenlänge millimetergenau auf Kundenwunsch möglich. Oberfläche der Leuchte feinstruktur matt pulverbeschichtet ähnlich RAL 9016 weiß, RAL 9006 silber oder RAL 9005 schwarz – auf Anfrage in RAL nach Wahl. Diffusor wahlweise in PMMA opal oder PMMA klar mit eingeschobener mikroprismatischer Platte für eine reduzierte Leuchtdichte (UGR<19). Leuchte inkl. speziellem schnellmontage-Wandbaldachin (Montage mittels Stecker und Gegenstecker). Der LED-Treiber ist im Leuchtengehäuse integriert – wahlweise als on/off oder DALI-Variante. Farbtemperaturen 2700K, 3000K, 4000K oder dynamisch Weiß (2700K–6500K) – Farbwiedergabe CRI>80 oder CRI>90 – Mac Adam ≤3. Weitere Steuerungsoptionen oder Lichtfarben auf Anfrage erhältlich. Außerdem ist die Integration vieler Komponenten, wie beispielsweise Notlicht oder Sensortechnologie, sowie eine Vielzahl weiterer Optionen möglich.

Wall-mounted LED luminaire with direct beam or direct-indirect beam. Light channel made of extruded aluminium profile with a width of 50 mm. Luminaire length can be manufactured to the exact millimetre on customer request. Surface of the luminaire fine structure matt powder coated similar to RAL 9016 white, RAL 9006 silver or RAL 9005 black – on request in RAL of choice. Diffuser either in PMMA opal or PMMA clear with inserted microprismatic plate for reduced luminance (UGR<19). Luminaire incl. special quick-mount wall canopy (mounting with plug and counterplug). The LED driver is integrated in the luminaire housing - either as on/off or DALI version. Colour temperatures 2700K, 3000K, 4000K or dynamic white (2700K-6500K) - colour rendering CRI>80 or CRI>90 - Mac Adam ≤3. Further control options or light colours available on request. In addition, the integration of many components, such as emergency lighting or sensor technology, as well as a variety of other options is possible.

Luminaire LED mural à éclairage direct ou direct-indirect. Canal lumineux en profilé d'aluminium extrudé d'une largeur de 50 mm. Fabrication de la longueur du luminaire au millimètre près possible sur demande du client. Surface du luminaire à structure fine, revêtement par poudre mat similaire à RAL 9016 blanc, RAL 9006 argent ou RAL 9005 noir - sur demande en RAL au choix. Diffuseur au choix en PMMA opale ou en PMMA transparent avec plaque microprismatique insérée pour un éblouissement réduit (UGR<19). Luminaire mural spécial à montage rapide (montage au moyen d'une fiche et d'une contre-fiche). Le pilote LED est intégré dans le boîtier du luminaire - au choix sous forme de variante on/off ou DALI. Températures de couleur 2700K, 3000K, 4000K ou blanc dynamique (2700K-6500K) - Rendu des couleurs CRI>80 ou CRI>90 - Mac Adam ≤3. Autres options de commande ou couleurs de lumière disponibles sur demande. En outre, l'intégration de nombreux composants, tels que l'éclairage de secours ou la technologie de détection, une multitude d'autres options sont possibles.

ÜBERSICHT | OVERVIEW | VUE D'ENSEMBLE

TECHNICAL DATA

2700K / 3000K / 4000K / 2700-6500K

CRI>80 / CRI>90

MacAdam ≤ 3

up to 149 lm/W, up to 6.554 lm/m

on-off / DALI

direct / direct + indirect

opal / microprism (UGR <19)

L80 B10 50.000h

HOUSING COLOUR

schwarz | black | noir
RAL 9005

silber | silver | argent
RAL 9006

weiß | white | blanc
RAL 9016



RAL colour of your choice



Integration of 3-phase-track



Integration of Multisensor



Welded mitre cuts



Integration of emergency light



Integration of GLOWmini/
GLOWsmall series



Contact us for more options...

WANDLEUCHTE „LINE50“
WALL LUMINAIRE “LINE50”
APPLIQUE MURALE « LINE50 »

Bestellbeispiel | Example order | Exemple de commande
 3.134 mm, CRI>90, 4000K, direct + indirect, low output on/off, black, microprism

LI50W-319402-LOBLM



1 LÄNGE LENGTH LONGEUR	
614 mm	06
974 mm	09
1.214 mm	12
1.454 mm	14
1.694 mm	16
1.934 mm	19
2.174 mm	21
2.414 mm	24
2.894 mm	28
3.134 mm	31
3.856 mm	38

2 FARBWIEDERGABE COLOUR RENDERING RENDU DES COULEURS	
CRI>80	8
CRI>90	9

3 FARBTEMPERATUR COLOUR TEMPERATURE TEMPÉRATURE DE COULEUR	
2700K (CRI>90 only)	27
3000K	30
4000K	40
2700-6500K (CRI>90 only)	DW

4 LICHTVERTEILUNG LIGHT DISTRIBUTION DISTRIBUTION DE LA LUMIÈRE	
direct	1
direct + indirect	2

5 LEISTUNG & STEUERUNG OUTPUT & CONTROL SORTIE & CONTRÔLE	
low output on/off	LO
low output DALI	LD
high output on/off	HO
high output DALI	HD
dynamic white DALI DT8	DW

6 GEHÄUSEFARBE HOUSING COLOUR COULEUR DU BOÎTIER	
silver RAL 9006	SI
white RAL 9016	WH
black RAL 9005	BL

7 DIFFUSOR DIFFUSER DIFFUSEUR	
opal	O
microprism	M

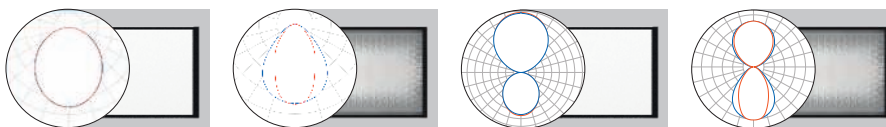
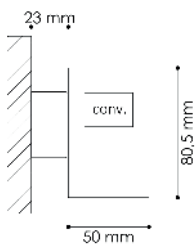

Size [mm]	opal direct		microprism direct		opal direct + indirect		microprism direct + indirect		direct	direct + indirect
	low output [lm] / [W]	high output [lm] / [W]	low output [lm] / [W]	high output [lm] / [W]	low output [lm] / [W]	high output [lm] / [W]	low output [lm] / [W]	high output [lm] / [W]	kg	kg
614	909 / 8,8	1.731 / 16,3	826 / 8,8	1.581 / 16,3	2.060 / 16,3	3.949 / 30,0	1.923 / 16,3	3.668 / 30,0	1,5	1,8
974	1.455 / 13,0	2.770 / 25,0	1.321 / 13,0	2.530 / 25,0	3.296 / 23,7	6.319 / 46,3	3.077 / 23,7	5.869 / 46,3	2,3	3,0
1.214	1.818 / 16,3	3.463 / 30,0	1.652 / 16,3	3.162 / 30,0	4.120 / 29,1	7.898 / 57,2	3.845 / 29,1	7.336 / 57,2	2,9	3,6
1.454	2.182 / 18,5	4.156 / 35,8	1.982 / 18,5	3.794 / 35,8	4.944 / 34,5	9.477 / 68,1	4.615 / 34,5	8.803 / 68,1	3,5	4,4
1.694	2.546 / 21,2	4.848 / 41,1	2.313 / 21,2	4.427 / 41,1	5.769 / 39,5	11.057 / 80,8	5.384 / 39,5	10.270 / 80,8	4,1	5,1
1.934	2.911 / 23,7	5.541 / 46,3	2.642 / 23,7	5.059 / 46,3	6.592 / 44,6	12.636 / 91,7	6.154 / 44,6	11.738 / 91,7	4,6	5,8
2.174	3.273 / 26,6	6.233 / 52,0	2.974 / 26,6	5.692 / 52,0	7.416 / 49,9	14.217 / 103,0	6.923 / 49,9	13.205 / 103,0	5,2	6,5
2.414	3.635 / 29,2	6.926 / 57,3	3.304 / 29,2	6.324 / 57,3	8.240 / 56,0	15.796 / 113,1	7.690 / 56,0	14.672 / 113,1	5,8	7,2
2.894	4.364 / 34,3	8.311 / 69,6	3.964 / 34,3	7.589 / 69,6	9.889 / 67,0	18.955 / 134,8	9.230 / 67,0	17.606 / 134,8	7,0	8,7
3.134	4.728 / 36,9	9.004 / 75,5	4.295 / 36,9	8.221 / 75,5	10.712 / 72,0	20.534 / 145,3	9.999 / 72,3	19.074 / 145,3	7,5	9,4
3.856	5.821 / 47,4	11.082 / 92,6	5.284 / 47,4	10.118 / 92,6	13.183 / 89,0	25.273 / 183,4	12.308 / 89,2	23.476 / 183,4	9,3	11,7

Alle Lumenangaben für 4000K, CRI>80, Microprisma ohne Opalfolie
 All lumen values for 4000K, CRI>80, microprism without opal foil
 Toutes les données de lumens pour 4000K, CRI>80, microprisme sans feuille opale

LINE70

WANDLEUCHTE | WALL LUMINAIRE | APPLIQUE MURALE



LED-Wandleuchte direktstrahlend oder direkt-indirektstrahlend. Lichtkanal aus Aluminium-Strangpressprofil mit einer Breite von 71 mm. Fertigung der Leuchtenlänge millimetergenau auf Kundenwunsch möglich. Oberfläche der Leuchte feinstrukturiert matt pulverbeschichtet ähnlich RAL 9016 weiß, RAL 9006 silber oder RAL 9005 schwarz – auf Anfrage in RAL nach Wahl. Diffusor wahlweise in PMMA opal oder PMMA klar mit eingeschobener mikroprismatischer Platte für eine reduzierte Leuchtdichte (UGR<19). Leuchte inkl. speziellem schnellmontage-Wandbaldachin (Montage mittels Stecker und Gegenstecker). Der LED-Treiber ist im Leuchtengehäuse integriert – wahlweise als on/off oder DALI-Variante. Farbtemperaturen 2700K, 3000K, 4000K oder dynamisch Weiß (2700K–6500K) – Farbwiedergabe CRI>80 oder CRI>90 – Mac Adam ≤3. Weitere Steuerungsoptionen oder Lichtfarben auf Anfrage erhältlich. Außerdem ist die Integration vieler Komponenten, wie beispielsweise Notlicht oder Sensortechnologie, sowie eine Vielzahl weiterer Optionen möglich.

Wall-mounted LED luminaire with direct beam or direct-indirect beam. Light channel made of extruded aluminium profile with a width of 71 mm. Luminaire length can be manufactured to the exact millimetre on customer request. Surface of the luminaire fine structure matt powder coated similar to RAL 9016 white, RAL 9006 silver or RAL 9005 black – on request in RAL of choice. Diffuser either in PMMA opal or PMMA clear with inserted microprismatic plate for reduced luminance (UGR<19). Luminaire incl. special quick-mount wall canopy (mounting with plug and counterplug). The LED driver is integrated in the luminaire housing - either as on/off or DALI version. Colour temperatures 2700K, 3000K, 4000K or dynamic white (2700K-6500K) - colour rendering CRI>80 or CRI>90 - Mac Adam ≤3. Further control options or light colours available on request. In addition, the integration of many components, such as emergency lighting or sensor technology, as well as a variety of other options is possible.

Luminaire LED mural à éclairage direct ou direct-indirect. Canal lumineux en profilé d'aluminium extrudé d'une largeur de 71 mm. Possibilité de fabriquer la longueur du luminaire au millimètre près sur demande du client. Surface du luminaire à structure fine, revêtement par poudre mat similaire à RAL 9016 blanc, RAL 9006 argent ou RAL 9005 noir - sur demande en RAL au choix. Diffuseur au choix en PMMA opale ou en PMMA transparent avec plaque microprismatique insérée pour un éblouissement réduit (UGR<19). Luminaire mural spécial à montage rapide (montage au moyen d'une fiche et d'une contre-fiche). Le pilote LED est intégré dans le boîtier du luminaire - au choix sous forme de variante on/off ou DALI. Températures de couleur 2700K, 3000K, 4000K ou blanc dynamique (2700K-6500K) - Rendu des couleurs CRI>80 ou CRI>90 - Mac Adam ≤3. Autres options de commande ou couleurs de lumière disponibles sur demande. En outre, l'intégration de nombreux composants, tels que l'éclairage de secours ou la technologie de détection, une multitude d'autres options sont possibles.

ÜBERSICHT | OVERVIEW | VUE D'ENSEMBLE

TECHNICAL DATA

2700K / 3000K / 4000K / 2700-6500K

CRI>80 / CRI>90

MacAdam ≤ 3

up to 161 lm/W, up to 6.958 lm/m

on-off / DALI

direct / direct + indirect

opal / microprism (UGR <19)

L80 B10 50.000h

HOUSING COLOUR

schwarz | black | noir
RAL 9005

silber | silver | argent
RAL 9006

weiß | white | blanc
RAL 9016



RAL colour of your choice



Integration of Multisensor



Welded mitre cuts



Integration of emergency light



Contact us for more options...

WANDLEUCHTE „LINE70“
WALL LUMINAIRE “LINE70”
APPLIQUE MURALE « LINE70 »

Bestellbeispiel | Example order | Exemple de commande
 3.134 mm, CRI>90, 4000K, direct + indirect, low Output on/off, black, microprism

LI70W-319402-LOBLM

1 2 3 4 5 6 7

1 LÄNGE LENGTH LONGEUR	
614 mm	06
974 mm	09
1.214 mm	12
1.454 mm	14
1.694 mm	16
1.934 mm	19
2.174 mm	21
2.414 mm	24
2.894 mm	28
3.134 mm	31
3.856 mm	38

2 FARBWIEDERGABE COLOUR RENDERING RENDU DES COULEURS	
CRI>80	8
CRI>90	9

3 FARBTEMPERATUR COLOUR TEMPERATURE TEMPÉRATURE DE COULEUR	
2700K (CRI>90 only)	27
3000K	30
4000K	40
2700-6500K (CRI>90 only)	DW

4 LICHTVERTEILUNG LIGHT DISTRIBUTION DISTRIBUTION DE LA LUMIÈRE	
direct	1
direct + indirect	2

5 LEISTUNG & STEUERUNG OUTPUT & CONTROL SORTIE & CONTRÔLE	
low output on/off	LO
low output DALI	LD
high output on/off	HO
high output DALI	HD
dynamic white DALI DT8	DW

6 GEHÄUSEFARBE HOUSING COLOUR COULEUR DU BOTTIER	
silver RAL 9006	SI
white RAL 9016	WH
black RAL 9005	BL

7 DIFFUSOR DIFFUSER DIFFUSEUR	
opal	O
microprism	M

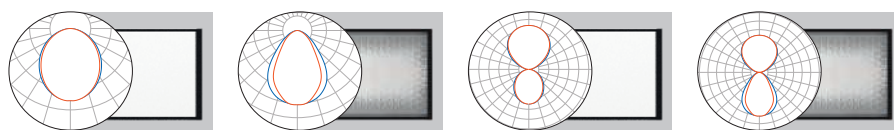
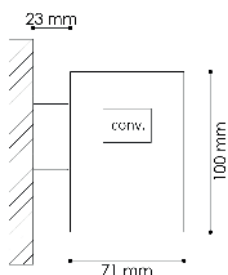

Size [mm]	opal direct		microprism direct		opal direct + indirect		microprism direct + indirect		direct	direct + indirect
	low output [lm] / [W]	high output [lm] / [W]	low output [lm] / [W]	high output [lm] / [W]	low output [lm] / [W]	high output [lm] / [W]	low output [lm] / [W]	high output [lm] / [W]	KG	KG
614	1.077 / 11,8	1.709 / 16,3	1.045 / 11,8	1.608 / 16,3	2.568 / 18,8	4.088 / 30,0	2.536 / 18,8	3.987 / 30	2,8	2,8
974	1.723 / 15,2	2.734 / 25,0	1.672 / 15,2	2.573 / 25,0	4.109 / 28,7	6.541 / 46,3	4.058 / 28,7	6.379 / 46,3	3,8	3,9
1.214	2.154 / 18,8	3.418 / 30,0	2.090 / 18,8	3.216 / 30,0	5.136 / 35,4	8.176 / 57,2	5.072 / 35,4	7.974 / 57,2	4,3	4,4
1.454	2.585 / 22,1	4.102 / 35,8	2.508 / 22,1	3.859 / 35,8	6.163 / 41,6	9.811 / 68,1	6.086 / 41,6	9.569 / 68,1	4,9	5,1
1.694	3.016 / 25,5	4.785 / 41,1	2.926 / 25,5	4.502 / 41,1	7.190 / 47,9	11.446 / 80,8	7.100 / 47,9	11.164 / 80,8	5,5	5,7
1.934	3.446 / 28,7	5.469 / 46,3	3.344 / 28,7	5.146 / 46,3	8.218 / 54,5	13.082 / 91,7	8.116 / 54,5	12.758 / 91,7	6,1	6,3
2.174	3.877 / 32,0	6.152 / 52,0	3.762 / 32,0	5.789 / 52,0	9.245 / 60,8	14.717 / 103,0	9.130 / 60,8	14.353 / 103,0	6,7	7,0
2.414	4.308 / 35,4	6.836 / 57,3	4.180 / 35,4	6.432 / 57,3	10.272 / 65,4	16.352 / 113,1	10.144 / 65,4	15.948 / 113,1	7,5	7,7
2.894	5.170 / 41,6	8.203 / 69,6	5.016 / 41,6	7.718 / 69,6	12.326 / 77,4	19.622 / 134,8	12.172 / 77,4	19.138 / 134,8	8,9	9,2
3.134	5.600 / 44,8	8.887 / 75,5	5.434 / 44,8	8.362 / 75,5	13.354 / 83,4	21.258 / 145,3	13.189 / 83,4	20.732 / 145,3	9,5	9,9
3.856	6.892 / 57,4	10.938 / 92,6	6.688 / 57,4	10.292 / 92,6	16.436 / 109	26.164 / 183,4	16.232 / 109	25.516 / 183,4	11,7	12,1

Alle Lumenangaben für 4000K, CRI>80, Microprisma ohne Opalfolie
 All lumen values for 4000K, CRI>80, microprism without opal foil
 Toutes les données de lumens pour 4000K, CRI>80, microprisme sans feuille opale

ROUND90

WANDLEUCHE | WALL LUMINAIRE | APPLIQUE MURALE

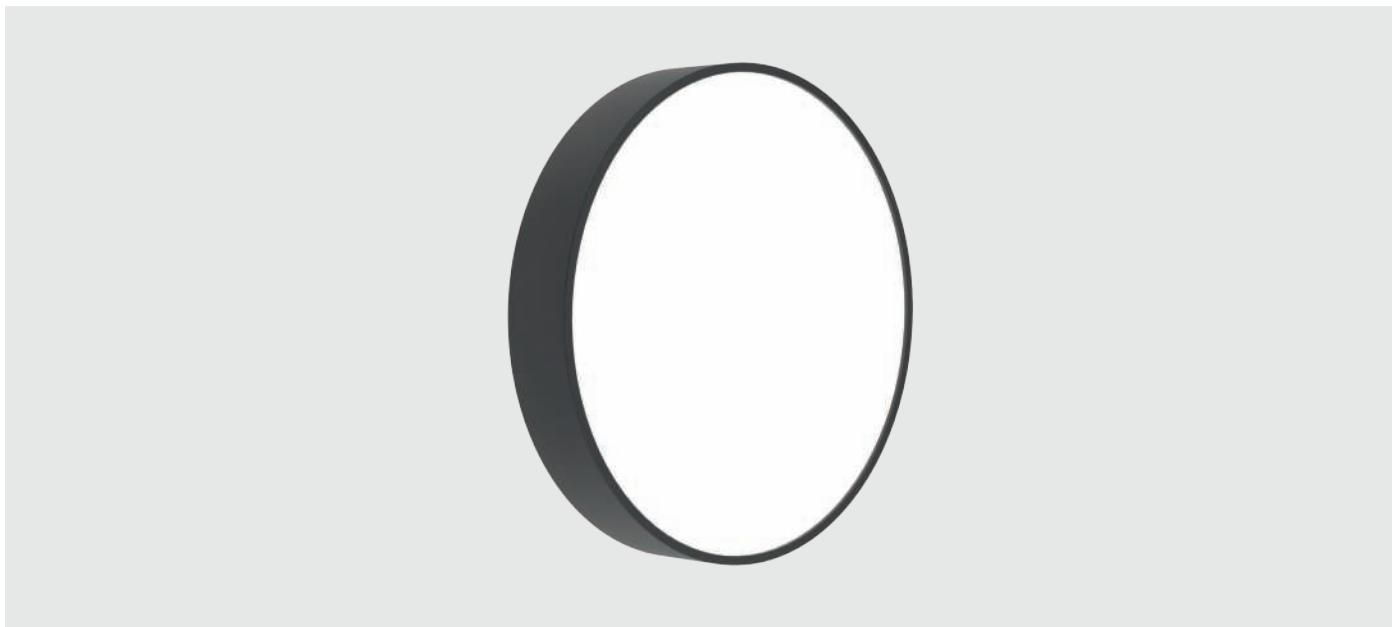

Runde LED-Flächenleuchte zur Wandmontage. Direktstrahlend oder direkt-indirektstrahlend. Gehäuse aus gerolltem Aluminiumprofil, nahtlos verschweißt. Fertigung der Leuchte in vier Durchmesser: 350, 450, 650 und 950 mm mit einer Gesamthöhe von 90 mm. Oberfläche pulverbeschichtet feinstruktur matt ähnlich RAL 9016 weiß, RAL 9006 silber oder RAL 9005 schwarz – auf Anfrage in RAL nach Wahl. Die durchdachte Konstruktion der Leuchte ermöglicht ein Design in zahlreichen Farbkombinationen – zwischen Gehäusefarbe und Dekorring kann beliebig kombiniert werden. Um der Leuchtenfamilie neben den Standardfarben einen dekorativen Touch zu verleihen, steht der Dekorring auch in den strukturierten Spezialoberflächen schlaggold, schlagsilber und schlagbronze zur Auswahl. Diffusor in PMMA wahlweise opal, mikroprismatisch inkl. Streufolie oder nur mikroprismatisch (office special) für eine reduzierte Leuchtdichte (UGR<19). Einfache Montage durch Einschieben des Leuchtgehäuses in den Baldachin. Der LED-Treiber ist im Leuchtgehäuse integriert – wahlweise als on/off oder DALI-Variante. Farbtemperaturen 2700K, 3000K, 4000K oder dynamisch Weiß (2700K–6500K) – Farbwiedergabe CRI>80 oder CRI>90 – Mac Adam ≤3. Weitere Steuerungsoptionen oder Lichtfarben auf Anfrage möglich. Außerdem ist die Integration vieler Komponenten, wie beispielsweise Notlicht oder Sensortechnologie, sowie eine Vielzahl weiterer Optionen möglich.

Round wall-mounted LED luminaire. Direct beam or direct-indirect beam. Housing made of rolled aluminium profile, seamlessly welded. Luminaire manufactured in four diameters: 350, 450, 650 and 950 mm with a total height of 90 mm. Surface powder coated fine structure matt similar to RAL 9016 white, RAL 9006 silver or RAL 9005 black - on request in RAL of choice. The sophisticated construction of the luminaire allows a design in numerous colour combinations - any combination of housing colour and decorative ring is also available in the special textured surfaces beaten gold, beaten silver and beaten bronze. Diffuser in PMMA either opal, microprism incl. diffuser foil or only microprism (office special) for reduced luminance (UGR<19). Easy installation by sliding the luminaire housing into the canopy. The LED driver is integrated in the luminaire housing - either as on/off or DALI version. Colour temperatures 2700K, 3000K, 4000K or dynamic white (2700K-6500K) - colour rendering CRI>80 or CRI>90 - Mac Adam ≤3. Further control options or light colours available on request. In addition, the integration of many components, such as emergency lighting or sensor technology, as well as a variety of other options is possible.

Luminaire LED rond pour montage mural. Éclairage direct ou éclairage direct-indirect. Boîtier en profilé d'aluminium roulé, soudé sans soudure. Fabrication du luminaire en quatre diamètres : 350, 450, 650 et 950 mm avec une hauteur totale de 90 mm. Surface revêtue par poudre à structure fine mate similaire à RAL 9016 blanc, RAL 9006 argent ou RAL 9005 noir - sur demande en RAL au choix. La construction bien pensée du luminaire permet un design dans de nombreuses combinaisons de couleurs - il est possible de combiner à volonté entre la couleur du boîtier et l'anneau décoratif. Pour donner à la famille de luminaires une touche décorative en plus des couleurs standard, l'anneau décoratif est également disponible dans les surfaces spéciales structurées or choc, argent choc et bronze choc. Diffuseur en PMMA au choix opale, microprismatique y compris feuille diffusante ou uniquement microprismatique (office special) pour un éblouissement réduit (UGR<19). Montage facile en insérant le corps du luminaire dans le canopy. Le driver LED est intégré dans le boîtier du luminaire - au choix en version on/off ou DALI. Températures de couleur 2700K, 3000K, 4000K ou blanc dynamique (2700K-6500K) - Rendu des couleurs CRI>80 ou CRI>90 - Mac Adam ≤3. Autres options de commande ou couleurs de lumière possibles sur demande. En outre, l'intégration de nombreux composants, tels que l'éclairage de secours ou la technologie des capteurs, une multitude d'autres options sont possibles.

ÜBERSICHT | OVERVIEW | VUE D'ENSEMBLE

TECHNICAL DATA	
2700K / 3000K / 4000K / 2700-6500K	
CRI>80 / CRI>90	
MacAdam ≤ 3	
up to 174 lm/W	
on-off / DALI	
direct / direct + indirect	
opal / microprism / office special (UGR <19)	
L80 B10 50.000h	
HOUSING COLOUR	
schwarz black noir RAL 9005	
silber silver argent RAL 9006	
weiß white blanc RAL 9016	

RAL colour of your choice	Integration of Multisensor	Integration of emergency light	Contact us for more options...					
DECORATION RING COLOUR								
schwarz black noir RAL 9005		schlaggold beaten gold or texturés						
silber silver argent RAL 9006		schlagsilber beaten silver argent texturés						
weiß white blanc RAL 9016		schlagbronze beaten bronze bronze texturés						

WANDLEUCHTE „ROUND90“
WALL LUMINAIRE "ROUND90"
APPLIQUE MURALE « ROUND90 »

Bestellbeispiel | Example order | Exemple de commande
 350 mm, CRI>90, 4000K, direct, low output on/off, black, beaten gold, microprism

RO90W-359401-LOBGM

1 2 3 4 5 6 7 8

1	DURCHMESSER DIAMETER DIAMÈTRE	
	350 mm	35
	450 mm	45
	650 mm	65
	950 mm	95
2	FARBWIEDERGABE COLOUR RENDERING RENDU DES COULEURS	
	CRI>80	8
	CRI>90	9
3	FARBTEMPERATUR COLOUR TEMPERATURE TEMPÉRATURE DE COULEUR	
	2700K (CRI>90 only)	27
	3000K	30
	4000K	40
	2700-6500K (CRI>90 only)	DW

4	LICHTVERTEILUNG LIGHT DISTRIBUTION DISTRIBUTION DE LA LUMIÈRE	
	direct	1
	direct + indirect	2
5	LEISTUNG & STEUERUNG OUTPUT & CONTROL SORTIE & CONTRÔLE	
	low output on/off	LO
	low output DALI	LD
	high output on/off	HO
	high output DALI	HD
	dynamic white DALI DT8	DW
6	GEHÄUSEFARBE HOUSING COLOUR COULEUR DU BOÎTIER	
	black RAL 9005	B
	silver RAL 9006	S
	white RAL 9016	W

7	DEKORRING FARBE DECORATION RING COLOUR BAGUE DÉCORATIVE COULEUR	
	black RAL 9005	B
	silver RAL 9006	S
	white RAL 9016	W
	beaten gold	G
	beaten silver	A
	beaten bronze	C
8	DIFFUSOR DIFFUSER DIFFUSEUR	
	opal	O
	microprism	M
	office special	B

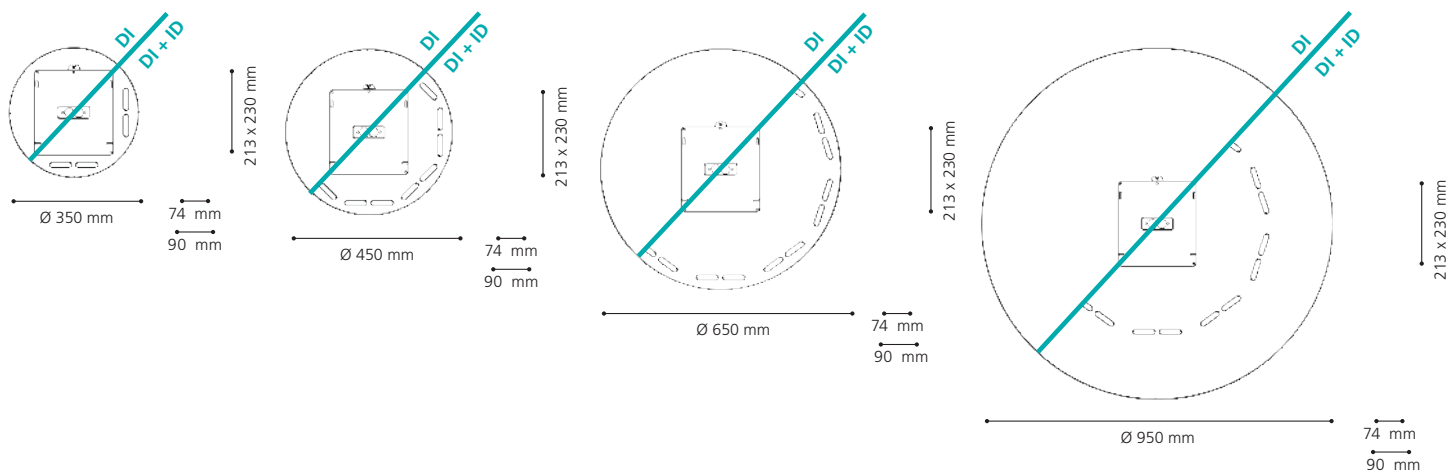

Size [mm]	opal direct		microprism direct		office special direct		opal direct + indirect		microprism direct + indirect		office special direct + indirect		KG
	low output [lm] / [W]	high output [lm] / [W]	low output [lm] / [W]	high output [lm] / [W]	low output [lm] / [W]	high output [lm] / [W]	low output [lm] / [W]	high output [lm] / [W]	low output [lm] / [W]	high output [lm] / [W]	low output [lm] / [W]	high output [lm] / [W]	
Ø 350	1.158 / 8,5	1.826 / 12,9	1.077 / 8,5	1.697 / 12,9	1.213 / 8,5	1.905 / 12,9	1.747 / 11,9	2.625 / 17,5	1.661 / 11,9	2.493 / 17,5	1.795 / 11,9	2.691 / 17,5	3,4
Ø 450	2.258 / 15,5	3.561 / 23,5	2.099 / 15,5	3.309 / 23,5	2.364 / 15,5	3.715 / 23,5	3.207 / 20,7	4.820 / 30,3	3.050 / 20,7	4.577 / 30,2	3.296 / 20,7	4.942 / 30,3	4,0
Ø 650	4.114 / 27,2	6.489 / 41,3	3.825 / 27,2	6.029 / 41,3	4.309 / 27,2	6.770 / 41,3	5.534 / 35,2	8.317 / 51,3	5.263 / 35,2	7.897 / 51,3	5.687 / 35,2	8.526 / 51,3	7,6
Ø 950	9.102 / 56,7	14.360 / 86,0	8.466 / 56,7	13.342 / 86,0	9.535 / 56,7	14.982 / 86,0	11.036 / 67,7	16.585 / 99,1	10.494 / 67,7	15.748 / 99,1	11.342 / 67,7	17.004 / 99,1	19,0

Alle Lumenangaben für 4000K, CRI>80, Gehäusefarbe weiß
 All lumen values for 4000K, CRI>80, housing colour white
 Toutes les données de lumens pour 4000K, CRI>80, couleur du boîtier blanc

SQUARE90

WANDLEUCHTE | WALL LUMINAIRE | APPLIQUE MURALE

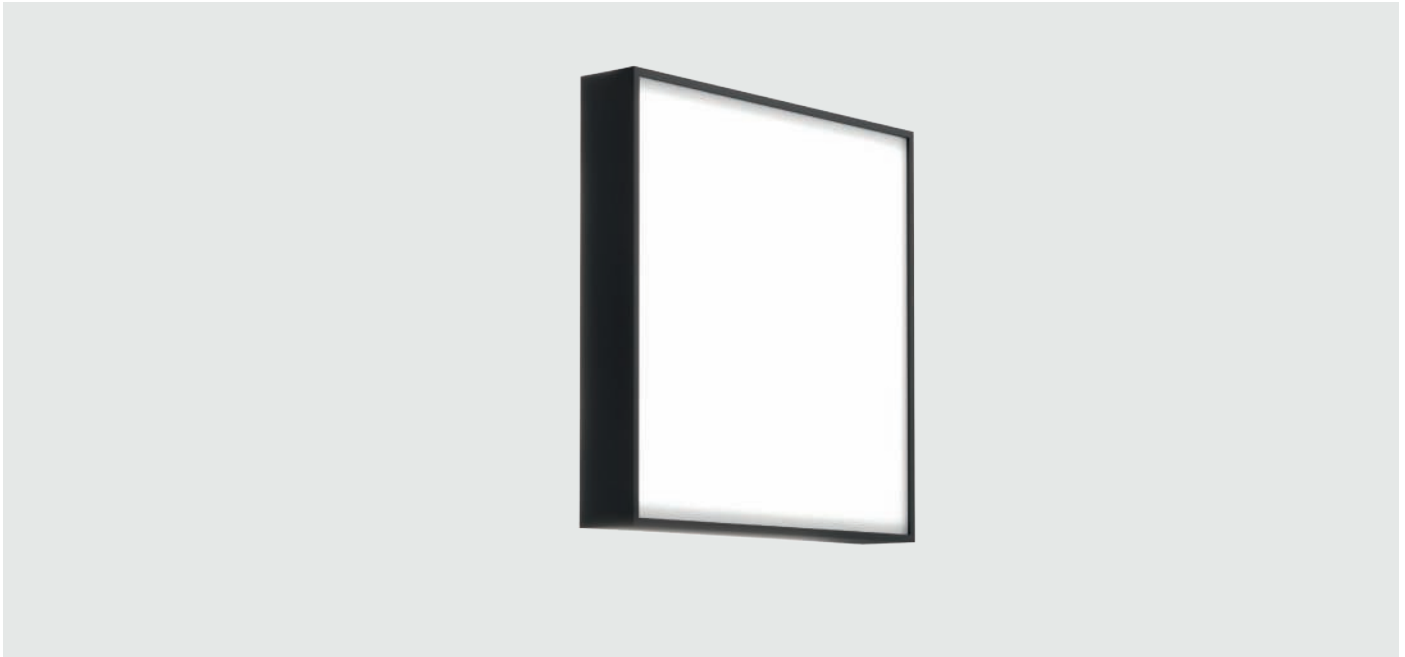

Quadratische LED-Flächenleuchte zur Wandmontage. Direktstrahlend oder direkt-indirektstrahlend. Gehäuse aus Aluminiumprofil, nahtlos verschweißt. Fertigung der Leuchte in vier Größen: 350, 450, 650 und 950 mm mit einer Gesamthöhe von 90 mm. Oberfläche pulverbeschichtet feinstruktur matt ähnlich RAL 9016 weiß, RAL 9006 silber oder RAL 9005 schwarz – auf Anfrage in RAL nach Wahl. Die durchdachte Konstruktion der Leuchte ermöglicht ein Design in zahlreichen Farbkombinationen – zwischen Gehäusefarbe und Dekorring kann beliebig kombiniert werden. Um der Leuchtenfamilie neben den Standardfarben einen dekorativen Touch zu verleihen, steht der Dekorring auch in den strukturierten Spezialoberflächen schlaggold, schlagsilber und schlagbronze zur Auswahl. Diffusor in PMMA wahlweise opal, mikroprismatisch inkl. Streufolie oder nur mikroprismatisch (office special) für eine reduzierte Leuchtdichte (UGR<19). Einfache Montage durch Einschieben des Leuchtengehäuses in den Baldachin. Der LED-Treiber ist im Leuchtengehäuse integriert – wahlweise als on/off oder DALI-Variante. Farbtemperaturen 2700K, 3000K, 4000K oder dynamisch Weiß (2700K–6500K) – Farbwiedergabe CRI>80 oder CRI>90 – Mac Adam ≤3. Weitere Steuerungsoptionen oder Lichtfarben auf Anfrage möglich. Außerdem ist die Integration vieler Komponenten, wie beispielsweise Notlicht oder Sensortechnologie, sowie eine Vielzahl weiterer Optionen möglich.

Square wall-mounted LED luminaire. Direct beam or direct-indirect beam. Housing made of aluminium profile, seamlessly welded. Luminaire manufactured in four sizes: 350, 450, 650 and 950 mm with a total height of 90 mm. Surface powder coated fine structure matt similar to RAL 9016 white, RAL 9006 silver or RAL 9005 black - on request in RAL of choice. The sophisticated construction of the luminaire allows a design in numerous colour combinations - any combination of housing colour and decorative ring is possible. To give the luminaire family a decorative touch in addition to the standard colours, the decorative ring is also available in the structured special surfaces of beaten gold, beaten silver and beaten bronze. Diffuser in PMMA either opal, microprism incl. diffuser foil or only microprism (office special) for reduced luminance (UGR<19). Easy mounting by sliding the luminaire housing into the canopy. The LED driver is integrated in the luminaire housing - either as on/off or DALI version. Colour temperatures 2700K, 3000K, 4000K or dynamic white (2700K-6500K) - colour rendering CRI>80 or CRI>90 - Mac Adam ≤3. Further control options or light colours available on request. In addition, the integration of many components, such as emergency lighting or sensor technology, as well as a variety of other options is possible.

Luminaire mural carré LED. Éclairage direct ou direct-indirect. Boîtier en profilé d'aluminium, soudé sans soudure. Fabrication du luminaire en quatre dimensions : 350, 450, 650 et 950 mm avec une hauteur totale de 90 mm. Surface revêtue par poudre à structure fine mate similaire à RAL 9016 blanc, RAL 9006 argent ou RAL 9005 noir - sur demande en RAL au choix. La construction bien pensée du luminaire permet un design dans de nombreuses combinaisons de couleurs - il est possible de combiner à volonté entre la couleur du boîtier et l'anneau décoratif. Pour donner à la famille de luminaires une touche décorative en plus des couleurs standard, l'anneau décoratif est également disponible dans les surfaces spéciales structurées or choc, argent choc et bronze choc. Diffuseur en PMMA au choix opale, microprismatique y compris film diffusant ou uniquement microprismatique (office special) pour un éblouissement réduit (UGR<19). Montage facile en insérant le corps du luminaire dans le canopy. Le driver LED est intégré dans le boîtier du luminaire - au choix en version on/off ou DALI. Températures de couleur 2700K, 3000K, 4000K ou blanc dynamique (2700K-6500K) - Rendu des couleurs CRI>80 ou CRI>90 - Mac Adam ≤3. Autres options de commande ou couleurs de lumière possibles sur demande. En outre, l'intégration de nombreux composants, tels que l'éclairage de secours ou la technologie des capteurs, une multitude d'autres options sont possibles.

ÜBERSICHT | OVERVIEW | VUE D'ENSEMBLE

TECHNICAL DATA

2700K / 3000K / 4000K / 2700-6500K

CRI>80 / CRI>90

MacAdam ≤ 3

up to 175 lm/W

on-off / DALI

direct / direct + indirect

opal / microprism / office special (UGR <19)

L80 B10 50.000h



RAL colour of your choice



Integration of Multisensor



Integration of emergency light



Contact us for more options...

HOUSING COLOUR

schwarz | black | noir
RAL 9005



silber | silver | argent
RAL 9006



weiß | white | blanc
RAL 9016



DECORATION RING COLOUR

schwarz | black | noir
RAL 9005



silber | silver | argent
RAL 9006



weiß | white | blanc
RAL 9016



schlaggold | beaten gold | or texturés



schlagsilber | beaten silver | argent texturés



schlagbronze | beaten bronze | bronze texturés



WANDLEUCHTE „SQUARE90“
WALL LUMINAIRE “SQUARE90”
APPLIQUE MURALE « SQUARE90 »

Bestellbeispiel | Example order | Exemple de commande
 350 mm, CRI>90, 4000K, direct, low output on/off, black, beaten gold, microprism

SQ90W-359401-LOBGM

1 2 3 4 5 6 7 8

1	GRÖSSE SIZE TAILLE	
	350 x 350 mm	35
	450 x 450 mm	45
	650 x 650 mm	65
	950 x 950 mm	95
2	FARBWIEDERGABE COLOUR RENDERING RENDU DES COULEURS	
	CRI>80	8
	CRI>90	9
3	FARBTEMPERATUR COLOUR TEMPERATURE TEMPÉRATURE DE COULEUR	
	2700K (CRI>90 only)	27
	3000K	30
	4000K	40
	2700-6500K (CRI>90 only)	DW

4	LICHTVERTEILUNG LIGHT DISTRIBUTION DISTRIBUTION DE LA LUMIÈRE	
	direct	1
	direct + indirect	2
5	LEISTUNG & STEUERUNG OUTPUT & CONTROL SORTIE & CONTRÔLE	
	low output on/off	LO
	low output DALI	LD
	high output on/off	HO
	high output DALI	HD
	dynamic white DALI DT8	DW
6	GEHÄUSEFARBE HOUSING COLOUR COULEUR DU BOÎTIER	
	black RAL 9005	B
	silver RAL 9006	S
	white RAL 9016	W

7	DEKORRING FARBE DECORATION RING COLOUR BAGUE DÉCORATIVE COULEUR	
	black RAL 9005	B
	silver RAL 9006	S
	white RAL 9016	W
	beaten gold	G
	beaten silver	A
	beaten bronze	C
8	DIFFUSOR DIFFUSER DIFFUSEUR	
	opal	O
	microprism	M
	office special	B

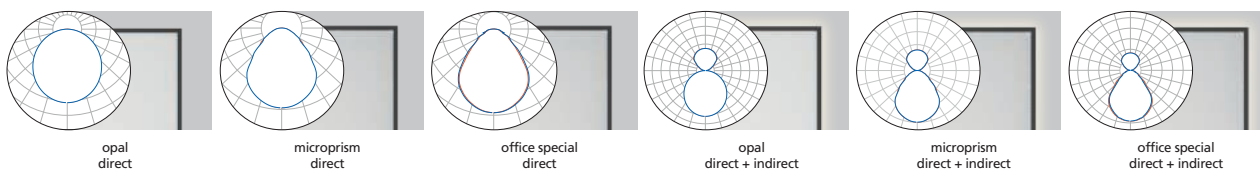
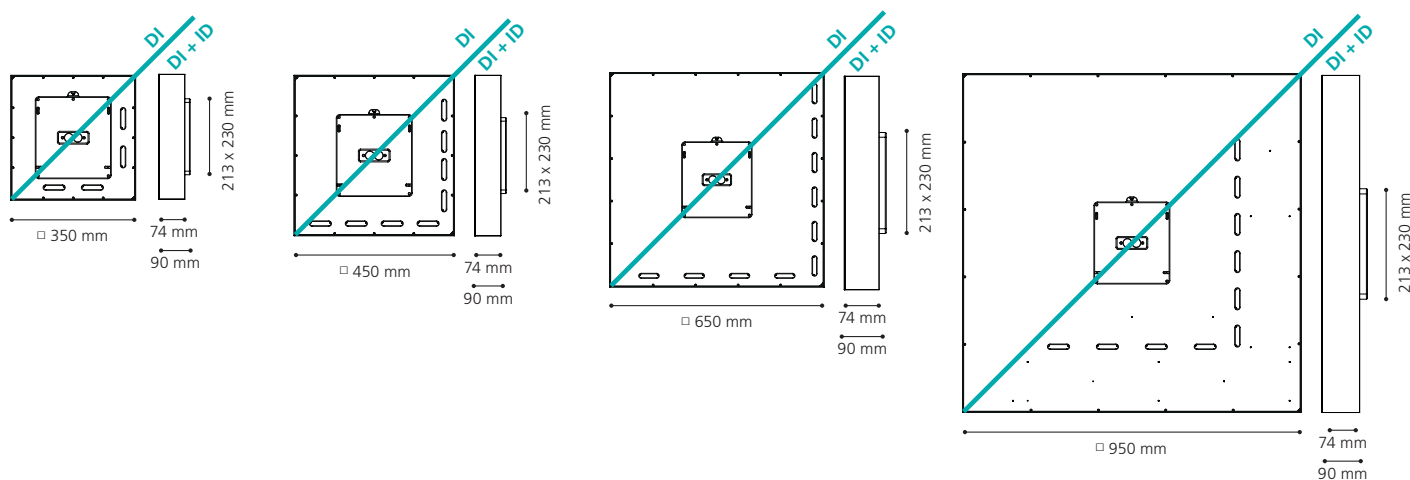

Size [mm]	opal direct		microprism direct		office special direct		opal direct + indirect		microprism direct + indirect		office special direct + indirect		kg
	low output [lm] / [W]	high output [lm] / [W]	low output [lm] / [W]	high output [lm] / [W]	low output [lm] / [W]	high output [lm] / [W]	low output [lm] / [W]	high output [lm] / [W]	low output [lm] / [W]	high output [lm] / [W]	low output [lm] / [W]	high output [lm] / [W]	
□ 350	1.349 / 9,9	2.365 / 16,7	1.256 / 9,9	2.208 / 16,7	1.402 / 9,9	2.470 / 16,7	2.029 / 13,8	3.488 / 23,1	1.923 / 13,8	3.308 / 23,1	2.081 / 13,8	3.579 / 23,1	3,9
□ 450	2.288 / 15,4	4.011 / 26,0	2.130 / 15,4	3.744 / 26,0	2.377 / 15,4	4.189 / 26,0	3.236 / 20,7	5.563 / 34,6	3.067 / 20,7	5.276 / 34,6	3.319 / 20,7	5.709 / 34,6	5,4
□ 650	4.711 / 30,5	8.258 / 51,6	4.385 / 30,5	7.708 / 51,6	4.894 / 30,5	8.624 / 51,6	5.845 / 37,0	10.048 / 61,8	5.845 / 37,0	9.530 / 61,8	5.995 / 37,0	10.312 / 61,8	9,3
□ 950	9.868 / 60,9	17.299 / 102,8	9.187 / 60,9	16.148 / 102,8	10.252 / 60,9	18.067 / 102,8	10.918 / 67,4	18.770 / 112,6	10.348 / 67,4	17.801 / 112,6	11.198 / 67,4	19.262 / 112,6	23,4

Alle Lumenangaben für 4000K, CRI>80, Gehäusefarbe weiß
 All lumen values for 4000K, CRI>80, housing colour white
 Toutes les données de lumens pour 4000K, CRI>80, couleur du boîtier blanc

OVERVIEW

EINBAULEUCHTEN | RECESSED LUMINAIRES | LUMINAIRES ENCASTRABLES



LINE40
194



LINE50
196



LINE50splash
198



officeLINE50
200



LINE70
202



RING50
204



FLEX50
206



ROUND90
208



DOWN75
210



designDOT
212

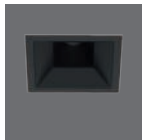

designSQOT
214



techDOT
216



techSQOT
218

EINBAULEUCHTEN

RECESSED LUMINAIRES

LUMINAIRES ENCASTRABLES

LINE40

EINBAULEUCHE | RECESSED LUMINAIRE | LUMINAIRE ENCASTRABLE

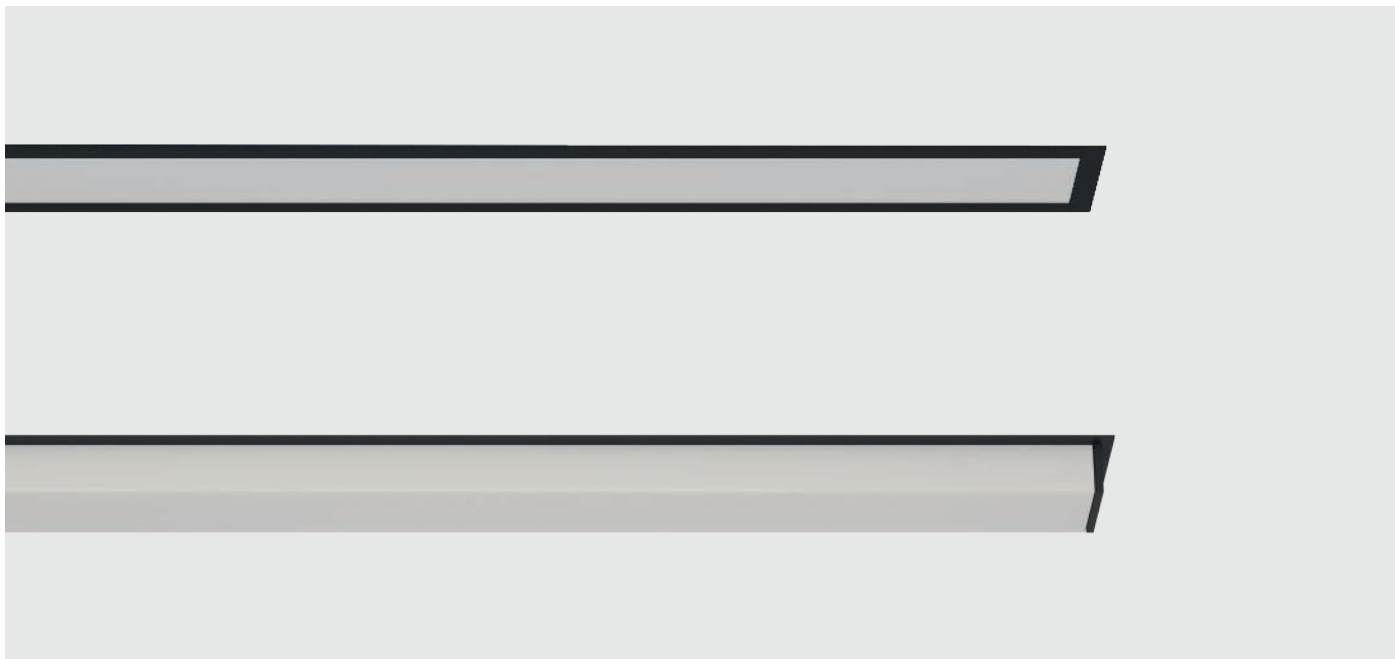

LED-Einbauleuchte mit umlaufendem Rahmen, direktstrahlend. Lichtkanal aus Aluminium-Strangpressprofil mit einer Gesamtbreite von 54 mm. Fertigung der Leuchtenlänge millimetergenau auf Kundenwunsch möglich. Oberfläche der Leuchte feinstruktur matt pulverbeschichtet ähnlich RAL 9016 weiß, RAL 9006 silber oder RAL 9005 schwarz – auf Anfrage in RAL nach Wahl. Diffusor wahlweise in PMMA opal, oder PMMA klar mit eingeschobener mikroprismatischer Platte für eine reduzierte Leuchtdichte (UGR<19). Der LED-Treiber ist im Leuchtengehäuse integriert – wahlweise als on/off oder DALI-Variante. Farbtemperaturen 2700K, 3000K, 4000K oder dynamisch Weiß (2700K-6500K) – Farbwiedergabe CRI>80 oder CRI>90 – Mac Adam ≤3. Weitere Steuerungsoptionen oder Lichtfarben auf Anfrage erhältlich. Außerdem ist die Integration vieler Komponenten, wie beispielsweise Notlicht oder Sensortechnologie, sowie eine Vielzahl weiterer Optionen möglich.

Recessed LED luminaire with surrounding frame, direct beam. Light channel made of extruded aluminium profile with a total width of 54 mm. Luminaire length can be manufactured to the exact millimetre on customer request. Surface of the luminaire fine structure matt powder coated similar to RAL 9016 white, RAL 9006 silver or RAL 9005 black - on request in RAL of choice. Diffuser either in PMMA opal or PMMA clear with inserted microprismatic plate for reduced luminance (UGR<19). The LED driver is integrated in the luminaire housing - either as on/off or DALI version. Colour temperatures 2700K, 3000K, 4000K or dynamic white (2700K-6500K) - colour rendering CRI>80 or CRI>90 - Mac Adam ≤3. Further control options or light colours available on request. In addition, the integration of many components, such as emergency lighting or sensor technology, as well as a variety of other options is possible.

Luminaire LED encastré avec cadre périphérique à éclairage direct. Canal lumineux en profilé d'aluminium extrudé d'une largeur totale de 54 mm. Fabrication de la longueur du luminaire au millimètre près possible sur demande du client. Surface du luminaire à structure fine, revêtement par poudre mat similaire à RAL 9016 blanc, RAL 9006 argent ou RAL 9005 noir - sur demande en RAL au choix. Diffuseur au choix en PMMA opale ou en PMMA transparent avec plaque microprismatique insérée pour un éblouissement réduit (UGR<19). Le pilote LED est intégré dans le boîtier du luminaire - au choix sous forme de variante on/off ou DALI. Températures de couleur 2700K, 3000K, 4000K ou blanc dynamique (2700K-6500K) - Rendu des couleurs CRI>80 ou CRI>90 - Mac Adam ≤3. Autres options de commande ou couleurs de lumière disponibles sur demande. En outre, l'intégration de nombreux composants, tels que l'éclairage de secours ou des capteurs, une multitude d'autres options sont possibles.

ÜBERSICHT | OVERVIEW | VUE D'ENSEMBLE

TECHNICAL DATA

2700K / 3000K / 4000K / 2700-6500K

CRI>80 / CRI>90

MacAdam ≤ 3

up to 124 lm/W, up to 2.849 lm/m

on-off / DALI

direct

opal / U-cover / microprism (UGR <19)

L80 B10 50.000h

HOUSING COLOUR

schwarz | black | noir
RAL 9005

silber | silver | argent
RAL 9006

weiß | white | blanc
RAL 9016



RAL colour of your choice



Integration of Multisensor



Welded mitre cuts



Integration of emergency light



Contact us for more options...

EINBAULEUCHE „LINE40“
RECESSED LUMINAIRE “LINE40”
LUMINAIRE ENCASTRABLE « LINE40 »

Bestellbeispiel | Example order | Exemple de commande
 3.141 mm, CRI>90, 4000K, **direct**, low output on/off, black, microprism

LI40E-319401-LOBLM

1 2 3 4 5 6

1 LÄNGE LENGTH LONGEUR	
621 mm	06
981 mm	09
1.221 mm	12
1.461 mm	14
1.701 mm	17
1.941 mm	19
2.181 mm	21
2.421 mm	24
2.901 mm	29
3.141 mm	31
3.863 mm	38

2 FARBWIEDERGABE COLOUR RENDERING RENDU DES COULEURS	
CRI>80	8
CRI>90	9

3 FARBTEMPERATUR COLOUR TEMPERATURE TEMPÉRATURE DE COULEUR	
2700K (CRI>90 only)	27
3000K	30
4000K	40
2700-6500K (CRI>90 only)	DW

4 LEISTUNG & STEUERUNG OUTPUT & CONTROL SORTIE & CONTRÔLE	
low output on/off	LO
low output DALI	LD
high output on/off	HO
high output DALI	HD
dynamic white DALI DT8	DW

5 GEHÄUSEFARBE HOUSING COLOUR COULEUR DU BOÎTIER	
silver RAL 9006	SI
white RAL 9016	WH
black RAL 9005	BL

6 DIFFUSOR DIFFUSER DIFFUSEUR	
opal	O
microprism	M
U-cover	U

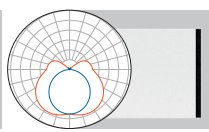
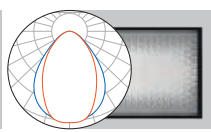
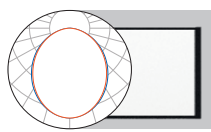
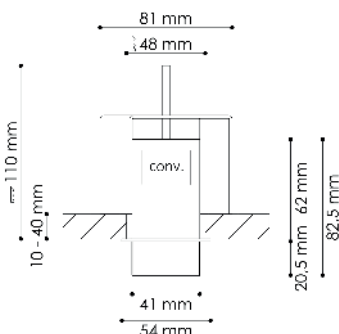
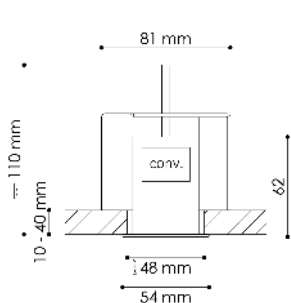

opal direct

microprism direct

U-cover direct

Size [mm]	low output [lm] / [W]		high output [lm] / [W]		low output [lm] / [W]		high output [lm] / [W]		kg
	low output [lm] / [W]	high output [lm] / [W]	low output [lm] / [W]	high output [lm] / [W]	low output [lm] / [W]	high output [lm] / [W]			
621	840 / 8,8	1.495 / 16,3	876 / 8,8	1.560 / 16,3	864 / 8,8	1.538 / 16,3	1,4		
981	1.324 / 13,0	2.461 / 25,0	1.381 / 13,0	2.567 / 25,0	1.362 / 13,0	2.532 / 25,0	2,1		
1.221	1.777 / 16,3	3.150 / 30,0	1.854 / 16,3	3.286 / 30,0	1.828 / 16,3	3.241 / 30,0	2,7		
1.461	2.010 / 18,5	3.763 / 35,8	2.097 / 18,5	3.925 / 35,8	2.068 / 18,5	3.871 / 35,8	3,2		
1.701	2.398 / 21,2	4.470 / 41,1	2.501 / 21,2	4.663 / 41,1	2.467 / 21,2	4.599 / 41,1	3,8		
1.941	2.779 / 23,7	5.222 / 46,3	2.889 / 23,7	5.448 / 46,3	2.859 / 23,7	5.373 / 46,3	4,3		
2.181	3.157 / 26,6	5.931 / 52,0	3.293 / 26,6	6.187 / 52,0	3.248 / 26,6	6.102 / 52,0	4,8		
2.421	3.441 / 29,2	6.544 / 57,3	3.590 / 29,2	6.826 / 57,3	3.541 / 29,2	6.732 / 57,3	5,4		
2.901	3.880 / 34,3	7.570 / 69,6	4.048 / 34,3	7.897 / 69,6	3.992 / 34,3	7.788 / 69,6	6,5		
3.141	4.326 / 36,9	8.516 / 75,5	4.513 / 36,9	8.884 / 75,5	4.451 / 36,9	8.761 / 75,5	6,9		
3.863	5.558 / 47,4	10.444 / 92,6	5.798 / 47,4	10.896 / 92,6	5.718 / 47,4	10.746 / 92,6	8,6		



CUTOUT

Size [mm]	length [mm]	width [mm]	depth [mm]
621	616	48	110
981	976	48	110
1.221	1.216	48	110
1.461	1.456	48	110
1.701	1.696	48	110
1.941	1.936	48	110
2.181	2.176	48	110
2.421	2.416	48	110
2.901	2.896	48	110
3.141	3.136	48	110
3.863	3.858	48	110

Alle Lumenangaben für 4000K, CRI>80, Microprisma ohne Opalfolie
 All lumen values for 4000K, CRI>80, microprism without opal foil
 Toutes les données de lumens pour 4000K, CRI>80, microprisme sans feuille opale

LINE50

EINBAULEUCHE | RECESSED LUMINAIRE | LUMINAIRE ENCASTRABLE



LED-Einbauleuchte mit umlaufendem Rahmen, direktstrahlend. Lichtkanal aus Aluminium-Strangpressprofil mit einer Gesamtbreite von 63 mm. Fertigung der Leuchtenlänge millimetergenau auf Kundenwunsch möglich. Oberfläche der Leuchte feinstruktur matt pulverbeschichtet ähnlich RAL 9016 weiß, RAL 9006 silber oder RAL 9005 schwarz – auf Anfrage in RAL nach Wahl. Diffusor wahlweise in PMMA opal, PMMA klar mit eingeschobener mikroprismatischer Platte für eine reduzierte Leuchtdichte (UGR<19). Der LED-Treiber ist im Leuchtengehäuse integriert – wahlweise als on/off oder DALI-Variante. Farbtemperaturen 2700K, 3000K, 4000K oder dynamisch Weiß (2700K–6500K) – Farbwiedergabe CRI>80 oder CRI>90 – Mac Adam ≤3. Weitere Steuerungsoptionen oder Lichtfarben auf Anfrage erhältlich. Außerdem ist die Integration vieler Komponenten, wie beispielsweise Notlicht oder Sensortechnologie, sowie eine Vielzahl weiterer Optionen möglich.

Recessed LED luminaire with surrounding frame, direct beam. Light channel made of extruded aluminium profile with a total width of 63 mm. Luminaire length can be manufactured to the exact millimetre on customer request. Surface of the luminaire fine structure matt powder coated similar to RAL 9016 white, RAL 9006 silver or RAL 9005 black - on request in RAL of choice. Diffuser either in PMMA opal, PMMA clear with inserted asymmetrical foil or PMMA clear with inserted microprismatic plate for reduced luminance (UGR<19). The LED driver is integrated in the luminaire housing - either as on/off or DALI version. Colour temperatures 2700K, 3000K, 4000K or dynamic white (2700K-6500K) - colour rendering CRI>80 or CRI>90 - Mac Adam ≤3. Further control options or light colours available on request. In addition, the integration of many components, such as emergency lighting or sensor technology, as well as a variety of other options is possible.

Luminaire LED encastré avec cadre périphérique à éclairage direct. Canal lumineux en profilé d'aluminium extrudé d'une largeur totale de 63 mm. Fabrication de la longueur du luminaire au millimètre près possible sur demande du client. Surface du luminaire à structure fine, revêtement par poudre mat similaire à RAL 9016 blanc, RAL 9006 argent ou RAL 9005 noir - sur demande en RAL au choix. Diffuseur au choix en PMMA opale, PMMA transparent avec feuille asymétrique insérée ou PMMA transparent avec plaque microprismatique insérée pour un éblouissement réduit (UGR<19). Le pilote LED est intégré dans le boîtier du luminaire - au choix sous forme de variante on/off ou DALI. Températures de couleur 2700K, 3000K, 4000K ou blanc dynamique (2700K-6500K) - Rendu des couleurs CRI>80 ou CRI>90 - Mac Adam ≤3. Autres options de commande ou couleurs de lumière disponibles sur demande. En outre, l'intégration de nombreux composants, tels que l'éclairage de secours ou la technologie de détection, une multitude d'autres options sont possibles.

ÜBERSICHT | OVERVIEW | VUE D'ENSEMBLE

TECHNICAL DATA

2700K / 3000K / 4000K / 2700-6500K

CRI>80 / CRI>90

MacAdam ≤ 3

up to 130 lm/W, up to 2.939 lm/m

on-off / DALI

direct

opal / microprism (UGR <19)

L80 B10 50.000h

HOUSING COLOUR

schwarz | black | *noir*
RAL 9005



silber | silver | *argent*
RAL 9006



weiß | white | *blanc*
RAL 9016



RAL colour of your choice



Integration of 3-phase-track



Integration of Multisensor



Welded mitre cuts



Integration of emergency light



Integration of GLOWmini/
GLOWsmall series



Contact us for more options...

EINBAULEUCHE „LINE50“
RECESSED LUMINAIRE “LINE50”
LUMINAIRE ENCASTRABLE « LINE50 »

Bestellbeispiel | Example order | Exemple de commande
 3.141 mm, CRI>90, 4000K, **direct**, low output on/off, black, microprism

LI50E-319401-LOBLM

1 2 3 4 5 6

1 LÄNGE LENGTH LONGEUR	
621 mm	06
981 mm	09
1.221 mm	12
1.461 mm	14
1.701 mm	17
1.941 mm	19
2.181 mm	21
2.421 mm	24
2.901 mm	29
3.141 mm	31
3.863 mm	38

2 FARBWIEDERGABE COLOUR RENDERING RENDU DES COULEURS	
CRI>80	8
CRI>90	9

3 FARBTEMPERATUR COLOUR TEMPERATURE TEMPÉRATURE DE COULEUR	
2700K (CRI>90 only)	27
3000K	30
4000K	40
2700-6500K (CRI>90 only)	DW

4 LEISTUNG & STEUERUNG OUTPUT & CONTROL SORTIE & CONTRÔLE	
low output on/off	LO
low output DALI	LD
high output on/off	HO
high output DALI	HD
dynamic white DALI DT8	DW

5 GEHÄUSEFARBE HOUSING COLOUR COULEUR DU BOÎTIER	
silver RAL 9006	SI
white RAL 9016	WH
black RAL 9005	BL

6 DIFFUSOR DIFFUSER DIFFUSEUR	
opal	O
microprism	M
asymmetric	A

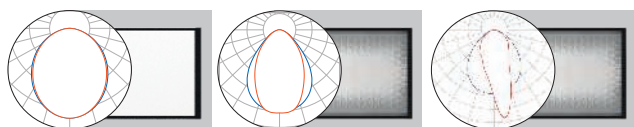
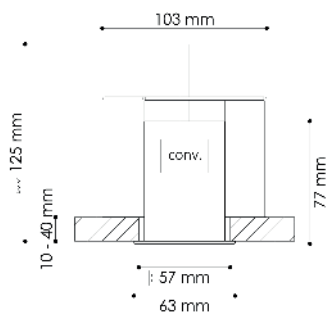

opal direct

microprism direct

asymmetric direct

Size [mm]	low output [lm] / [W]		high output [lm] / [W]		low output [lm] / [W]		high output [lm] / [W]		kg
	low output [lm] / [W]	high output [lm] / [W]	low output [lm] / [W]	high output [lm] / [W]	low output [lm] / [W]	high output [lm] / [W]			
621	909 / 8,8	1.731 / 16,3	826 / 8,8	1.581 / 16,3	925 / 8,8	1.771 / 16,3	1,5		
981	1455 / 13,0	2.770 / 25,0	1.321 / 13,0	2.530 / 25,0	1.480 / 13,0	2.834 / 25,0	2,3		
1.221	1.818 / 16,3	3.463 / 30,0	1.652 / 16,3	3.162 / 30,0	1.850 / 16,3	3.541 / 30,0	2,9		
1.461	2.182 / 18,5	4.156 / 35,8	1.982 / 18,5	3.794 / 35,8	2.220 / 18,5	4.249 / 35,8	3,5		
1.701	2.546 / 21,2	4.848 / 41,1	2.313 / 21,2	4.427 / 41,1	2.591 / 21,2	4.958 / 41,1	4,1		
1.941	2.911 / 23,7	5.541 / 46,3	2.642 / 23,7	5.059 / 46,3	2.959 / 23,7	5.666 / 46,3	4,6		
2.181	3.273 / 26,6	6.233 / 52,0	2.974 / 26,6	5.692 / 52,0	3.331 / 26,6	6.375 / 52,0	5,2		
2.421	3.635 / 29,2	6.926 / 57,3	3.304 / 29,2	6.324 / 57,3	3.700 / 29,2	7.083 / 57,3	5,8		
2.901	4.364 / 34,3	8.311 / 69,6	3.964 / 34,3	7.589 / 69,6	4.440 / 34,3	8.500 / 69,6	7,0		
3.141	4.728 / 36,9	9.004 / 75,5	4.295 / 36,9	8.221 / 75,5	4.810 / 36,9	9.208 / 75,5	7,5		
3.863	5.821 / 47,4	11.082 / 92,6	5.284 / 47,4	10.118 / 92,6	5.918 / 47,4	11.332 / 92,6	9,3		



CUTOUT

Size [mm]	length [mm]	width [mm]	depth [mm]
621	616	57	125
981	976	57	125
1.221	1.216	57	125
1.461	1.456	57	125
1.701	1.696	57	125
1.941	1.936	57	125
2.181	2.176	57	125
2.421	2.416	57	125
2.901	2.896	57	125
3.141	3.136	57	125
3.863	3.858	57	125

Alle Lumenangaben für 4000K, CRI>80, Microprisma ohne Opalfolie
 All lumen values for 4000K, CRI>80, microprism without opal foil
 Toutes les données de lumens pour 4000K, CRI>80, microprisme sans feuille opale

LINE50splash

EINBAULEUCHE | RECESSED LUMINAIRE | LUMINAIRE ENCASTRABLE



LED-Einbauleuchte mit erhöhter Schutzart IP54 mit umlaufendem Rahmen direktstrahlend. Lichtkanal aus Aluminium-Strangpressprofil mit einer Breite von 63 mm. Oberfläche der Leuchte feinstruktur matt pulverbeschichtet ähnlich RAL 9016 weiß, RAL 9006 silber oder RAL 9005 schwarz – auf Anfrage in RAL nach Wahl. Diffusor wahlweise in PMMA opal, PMMA klar mit eingeschobener asymmetrischer Folie oder PMMA klar mit eingeschobener mikroprismatischer Platte für eine reduzierte Leuchtdichte (UGR<19). Der LED-Treiber ist im Leuchtgehäuse integriert – wahlweise als on/off oder DALI-Variante – Farbtemperaturen 2700K, 3000K, 4000K oder dynamisch Weiß (2700K–6500K) – Farbwiedergabe CRI>80 oder CRI>90 – Mac Adam ≤3. Weitere Steuerungsoptionen oder Lichtfarben auf Anfrage erhältlich. Außerdem ist die Integration vieler Komponenten, wie beispielsweise Notlicht, sowie eine Vielzahl weiterer Optionen möglich.

Recessed LED luminaire with surrounding frame with increased protection rating IP54 and direct beam. Light channel made of extruded aluminium profile with a width of 63 mm. Surface of the luminaire fine structure matt powder coated similar to RAL 9016 white, RAL 9006 silver or RAL 9005 black - on request in RAL of choice. Diffuser either in PMMA opal, PMMA clear with inserted asymmetric foil or PMMA clear with inserted microprismatic plate for reduced luminance (UGR<19). The LED driver is integrated in the luminaire housing - either as on/off or DALI version - colour temperatures 2700K, 3000K, 4000K or dynamic white (2700K-6500K) - colour rendering CRI>80 or CRI>90 - Mac Adam ≤3. Further control options or light colours available on request. In addition, the integration of many components, such as emergency lighting, as well as a variety of other options is possible.

Luminaire LED encastré avec cadre périphérique et avec un degré de protection élevé IP54 à éclairage direct. Canal lumineux en profilé d'aluminium extrudé d'une largeur de 63 mm. Surface du luminaire à structure fine, revêtement par poudre mat similaire à RAL 9016 blanc, RAL 9006 argent ou RAL 9005 noir - sur demande en RAL au choix. Diffuseur au choix en PMMA opale, PMMA transparent avec feuille asymétrique insérée ou PMMA transparent avec plaque microprismatique insérée pour un éblouissement réduit (UGR<19). Le pilote LED est intégré dans le boîtier du luminaire - au choix sous forme de variante on/off ou DALI - températures de couleur 2700K, 3000K, 4000K ou blanc dynamique (2700K-6500K) - rendu des couleurs CRI>80 ou CRI>90 - Mac Adam ≤3. Autres options de commande ou couleurs de lumière disponibles sur demande. En outre, l'intégration de nombreux composants, tels que l'éclairage de secours, une multitude d'autres options sont possibles.

ÜBERSICHT | OVERVIEW | VUE D'ENSEMBLE

TECHNICAL DATA

2700K / 3000K / 4000K / 2700-6500K

CRI>80 / CRI>90

MacAdam ≤ 3

up to 130 lm/W, up to 2.930 lm/m

on-off / DALI

direct

opal / microprism (UGR <19) / asymmetric

L80 B10 50.000h

HOUSING COLOUR

schwarz | black | noir
RAL 9005

silber | silver | argent
RAL 9006

weiß | white | blanc
RAL 9016



RAL colour of your choice



Integration of emergency light



Contact us for more options...

EINBAULEUCHE „LINE50splash“
RECESSED LUMINAIRE “LINE50splash”
LUMINAIRE ENCASTRABLE « LINE50splash »

Bestellbeispiel | Example order | Exemple de commande
 3.152 mm, CRI90, 4000K, direct, low output on/off, black, microprism

LS50E-319401-LOBLM

1 2 3 4 5 6

1 LÄNGE
LENGTH
LONGEUR

632 mm	06
992 mm	09
1.232 mm	12
1.472 mm	14
1.712 mm	17
1.952 mm	19
2.192 mm	21
2.432 mm	24
2.912 mm	29
3.152 mm	31
3.874 mm	38

2 FARBWIEDERGABE
COLOUR RENDERING
RENDU DES COULEURS

CRI>80	8
CRI>90	9

3 FARBTEMPERATUR
COLOUR TEMPERATURE
TEMPÉRATURE DE COULEUR

2700K (CRI>90 only)	27
3000K	30
4000K	40
2700-6500K (CRI>90 only)	DW

4 LEISTUNG & STEUERUNG
OUTPUT & CONTROL
SORTIE & CONTRÔLE

low output on/off	LO
low output DALI	LD
high output on/off	HO
high output DALI	HD
dynamic white DALI DT8	DW

5 GEHÄUSEFARBE
HOUSING COLOUR
COULEUR DU BOÎTIER

silver RAL 9006	SI
white RAL 9016	WH
black RAL 9005	BL

6 DIFFUSOR
DIFFUSER
DIFFUSEUR

opal	O
microprism	M
asymmetric	A

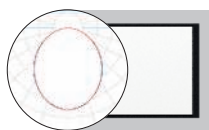
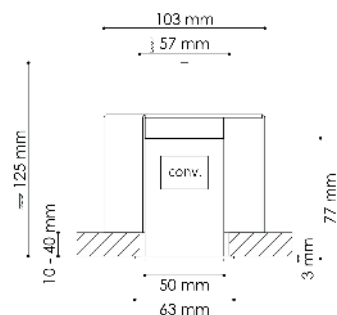

opal direct

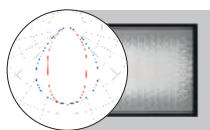

microprism direct

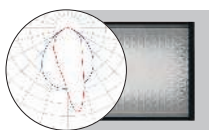

asymmetric direct

direct



CUTOUT

Size [mm]	low output [lm] / [W]	high output [lm] / [W]	low output [lm] / [W]	high output [lm] / [W]	low output [lm] / [W]	high output [lm] / [W]	38 kg
632	908 / 8,8	1.731 / 16,3	826 / 8,8	1.731 / 16,3	867 / 8,8	1.660 / 16,3	1,9
992	1.455 / 13,0	2.770 / 25,0	1.321 / 13,0	2.770 / 25,0	1.387 / 13,0	2.656 / 25,0	2,7
1.232	1.818 / 16,3	3.463 / 30,0	1.652 / 16,3	3.162 / 30,0	1.735 / 16,3	3.320 / 30,0	3,3
1.472	2.182 / 18,5	4.156 / 35,8	1.982 / 18,5	3.794 / 35,8	2.081 / 18,5	3.984 / 35,8	3,9
1.712	2.546 / 21,2	4.848 / 41,1	2.313 / 21,2	4.427 / 41,1	2.429 / 21,2	4.648 / 41,1	4,5
1.952	2.911 / 23,7	5.541 / 46,3	2.642 / 23,7	5.059 / 46,3	2.774 / 23,7	5.312 / 46,3	5,0
2.192	3.273 / 26,6	6.233 / 52,0	2.974 / 26,6	5.692 / 52,0	3.123 / 26,6	5.977 / 52,0	5,6
2.432	3.635 / 29,2	6.926 / 57,3	3.304 / 29,2	6.324 / 57,3	3.469 / 29,2	6.640 / 57,3	6,2
2.912	4.364 / 34,3	8.311 / 69,6	3.964 / 34,3	7.589 / 69,6	4.162 / 34,3	7.968 / 69,6	7,4
3.152	4.728 / 36,9	9.004 / 75,5	4.295 / 36,9	8.221 / 75,5	4.510 / 36,9	8.632 / 75,5	7,9
3.874	5.821 / 47,4	11.082 / 92,6	5.284 / 47,4	10.118 / 92,6	5.548 / 47,4	10.624 / 92,6	9,7

Size [mm]	length [mm]	width [mm]	depth [mm]
632	628	57	125
992	988	57	125
1.232	1.228	57	125
1.472	1.468	57	125
1.712	1.708	57	125
1.952	1.948	57	125
2.192	2.188	57	125
2.432	2.428	57	125
2.912	2.908	57	125
3.152	3.148	57	125
3.874	3.870	57	125

Alle Lumenangaben für 4000K, CRI>80, Microprisma ohne Opalfolie
 All lumen values for 4000K, CRI>80, microprism without opal foil
 Toutes les données de lumens pour 4000K, CRI>80, microprisme sans feuille opale

officeLINE50

Einbauleuchte | Recessed Luminaire | Luminaire Encastrable

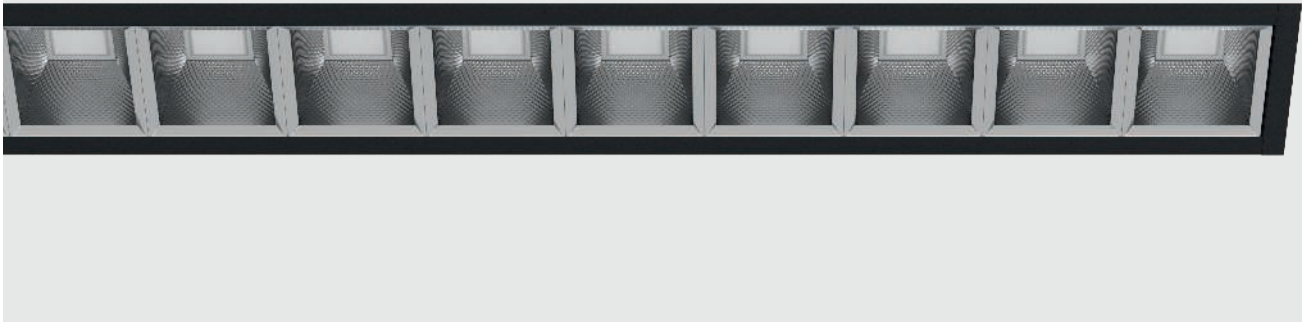

LED-Einbauleuchte mit umlaufendem Rahmen, direktstrahlend. Lichtkanal aus Aluminium-Strangpressprofil mit einer Gesamtbreite von 63 mm. Fertigung der Leuchtenlänge millimetergenau auf Kundenwunsch möglich. Oberfläche der Leuchte feinstruktur matt pulverbeschichtet ähnlich RAL 9016 weiß, RAL 9006 silber oder RAL 9005 schwarz – auf Anfrage in RAL nach Wahl. Die Leuchte ist ausgestattet mit einem hochwertigen, facettierten BAP-Raster mit einer Auswahl an sieben verschiedenen Farben – Oberfläche hochglänzend bzw. matt. Der LED-Treiber ist im Leuchtgehäuse integriert – wahlweise als on/off oder DALI-Variante. Farbtemperaturen 2700K, 3000K, 4000K oder dynamisch Weiß (2700K–6500K) – Farbwiedergabe CRI>80 oder CRI>90 – Mac Adam ≤3. Weitere Steuerungsoptionen oder Lichtfarben auf Anfrage erhältlich. Außerdem ist die Integration vieler Komponenten, wie beispielsweise Notlicht oder Sensortechnologie, sowie eine Vielzahl weiterer Optionen möglich.

Recessed LED luminaire with surrounding frame, direct beam. Light channel made of extruded aluminium profile with a total width of 63 mm. Luminaire length can be manufactured to the exact millimetre on customer request. Surface of the luminaire fine structure matt powder coated similar to RAL 9016 white, RAL 9006 silver or RAL 9005 black - on request in RAL of choice. The luminaire is equipped with a high-quality, faceted BAP louvre with a choice of seven different colours - specular or matt finish. The LED driver is integrated in the luminaire housing - either as on/off or DALI version. Colour temperatures 2700K, 3000K, 4000K or dynamic white (2700K-6500K) - Colour rendering CRI>80 or CRI>90 - Mac Adam ≤3. Further control options or light colours available on request. In addition, the integration of many components, such as emergency lighting or sensor technology, as well as a variety of other options is possible.

Luminaire LED encastré avec cadre périphérique à éclairage direct. Canal lumineux en profilé d'aluminium extrudé d'une largeur totale de 63 mm. Fabrication de la longueur du luminaire au millimètre près possible sur demande du client. Surface du luminaire à structure fine matte revêtue par poudre similaire à RAL 9016 blanc, RAL 9006 argent ou RAL 9005 noir - sur demande en RAL au choix. Le luminaire est équipé d'une grille BAP à facettes de haute qualité avec un choix de sept couleurs différentes - surface brillante ou mate. Le pilote LED est intégré dans le boîtier du luminaire - au choix sous forme de variante on/off ou DALI. Températures de couleur 2700K, 3000K, 4000K ou blanc dynamique (2700K-6500K) -Rendu des couleurs CRI>80 ou CRI>90 - Mac Adam ≤3. Autres options de commande ou couleurs de lumière disponibles sur demande. En outre, l'intégration de nombreux composants, tels que l'éclairage de secours ou la technologie de détection, une multitude d'autres options sont possibles.

ÜBERSICHT | OVERVIEW | VUE D'ENSEMBLE

TECHNICAL DATA

2700K / 3000K / 4000K / 2700-6500K

CRI>80 / CRI>90

MacAdam ≤ 3

up to 152 lm/W, up to 4.383 lm/m

on-off / DALI

direct

BAP-Louvre (UGR <19)

L80 B10 50.000h



RAL colour of your choice



Integration of 3-phase-track



Integration of Multisensor



Welded mitre cuts



Integration of emergency light



Integration of GLOWmini/
GLOWsmall series



Contact us for more options...

HOUSING COLOUR

schwarz | black | *noir*
RAL 9005



silber | silver | *argent*
RAL 9006



weiß | white | *blanc*
RAL 9016



DECORATION RING COLOUR

silber hochglanz | silver specular |
argenté brillant



gold hochglanz | gold specular | *doré brillant*



silber matt | silver matt | *argenté mat*



bronze hochglanz | bronze specular |
bronze brillant



schwarz hochglanz | black specular |
noir brillant



titan hochglanz | titan specular | *titan brillant*



schwarz matt | black matt | *noir mat*



EINBAULEUCHE „officeLINE50“
RECESSED LUMINAIRE “officeLINE50”
LUMINAIRE ENCASTRABLE « officeLINE50 »

Bestellbeispiel | Example order | Exemple de commande
 3.379 mm, CRI>90, 4000K, **direct**, low output on/off, black, gold specular

OL50E-339401-LOBLG

1 2 3 4 5 6

1 LÄNGE LENGTH LONGEUR	
498 mm	04
978 mm	09
1.218 mm	12
1.458 mm	14
1.698 mm	16
2.178 mm	21
2.898 mm	28
3.379 mm	33

2 FARBWIEDERGABE COLOUR RENDERING RENDU DES COULEURS	
CRI>80	8
CRI>90	9

3 FARBTEMPERATUR COLOUR TEMPERATURE TEMPÉRATURE DE COULEUR	
2700K (CRI>90 only)	27
3000K	30
4000K	40
2700-6500K (CRI>90 only)	DW

4 LEISTUNG & STEUERUNG OUTPUT & CONTROL SORTIE & CONTRÔLE	
low output on/off	LO
low output DALI	LD
high output on/off	HO
high output DALI	HD
dynamic white DALI DT8	DW

5 GEHÄUSEFARBE HOUSING COLOUR COULEUR DU BOÎTIER	
silver RAL 9006	SI
white RAL 9016	WH
black RAL 9005	BL

6 BAP-RASTER FARBE BAP LOUVRE COLOUR GRILLE BAP COULEUR	
silver specular	S
silver matt	M
black specular	N
black matt	B
gold specular	G
bronze specular	C
titan specular	T

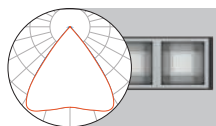
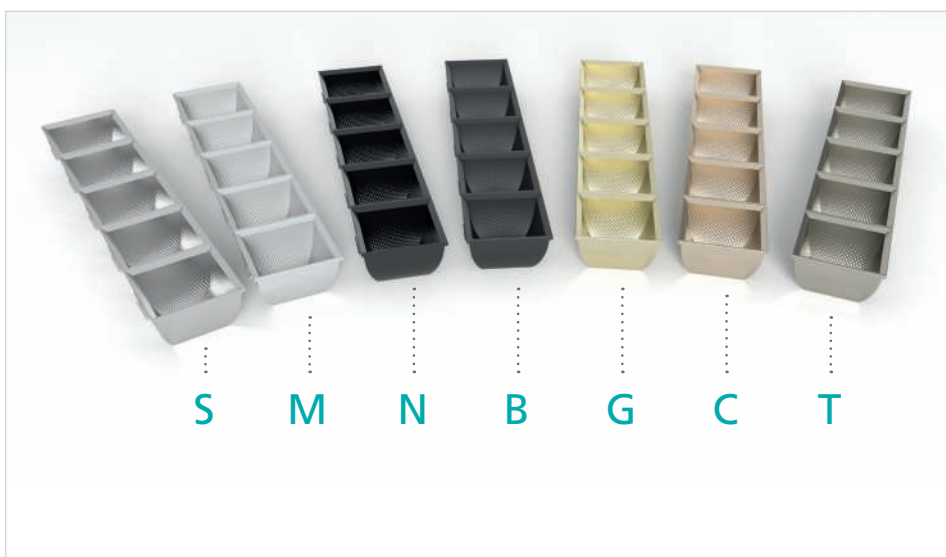
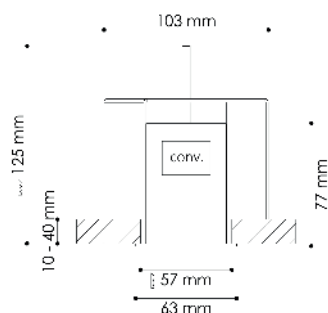

direct

Size [mm]	low output [lm] / [W]	high output [lm] / [W]	 [kg]
498	1.106 / 8,6	2.064 / 16,5	1,6
978	2.212 / 16,7	4.128 / 31,9	2,5
1.218	2.765 / 20,0	5.160 / 39,0	2,9
1.458	3.318 / 23,5	6.192 / 46,0	3,4
1.698	3.871 / 27,0	7.224 / 53,2	4,0
2.178	4.977 / 33,9	9.288 / 67,0	4,9
2.898	6.636 / 43,8	12.384 / 87,9	6,4
3.379	7.742 / 54,0	14.448 / 106,4	7,7



CUTOUT

Size [mm]	length [mm]	width [mm]	depth [mm]
498	493	57	125
978	973	57	125
1.218	1.213	57	125
1.458	1.453	57	125
1.698	1.693	57	125
2.178	2.173	57	125
2.898	2.893	57	125
3.379	3.374	57	125

Alle Lumenangaben für 4000K, CRI>80, Reflektor silber hochglanz
 All lumen values for 4000K, CRI>80, reflector silver specular
 Toutes les données de lumens pour 4000K, CRI>80, réflecteur argenté brillant

LINE70

EINBAULEUCHE | RECESSED LUMINAIRE | LUMINAIRE ENCASTRABLE



LED-Einbauleuchte mit umlaufendem Rahmen direktstrahlend. Lichtkanal aus Aluminium-Strangpressprofil mit einer Gesamtbreite von 88 mm. Fertigung der Leuchtenlänge millimetergenau auf Kundenwunsch möglich. Oberfläche der Leuchte feinstruktur matt pulverbeschichtet ähnlich RAL 9016 weiß, RAL 9006 silber oder RAL 9005 schwarz – auf Anfrage in RAL nach Wahl. Diffusor wahlweise in PMMA opal oder PMMA klar mit eingeschobener mikroprismatischer Platte für eine reduzierte Leuchtdichte (UGR<19). Der LED-Treiber ist im Leuchtengehäuse integriert – wahlweise als on/off oder DALI-Variante. Farbtemperaturen 2700K, 3000K, 4000K oder dynamisch Weiß (2700K–6500K) – Farbwiedergabe CRI>80 oder CRI>90 – Mac Adam ≤3. Weitere Steuerungsoptionen oder Lichtfarben auf Anfrage erhältlich. Außerdem ist die Integration vieler Komponenten, wie beispielsweise Notlicht oder Sensortechnologie, sowie eine Vielzahl weiterer Optionen möglich.

Recessed LED luminaire with surrounding frame, direct beam. Light channel made of extruded aluminium profile with a total width of 88 mm. Luminaire length can be manufactured to the exact millimetre on customer request. Surface of the luminaire fine structure matt powder coated similar to RAL 9016 white, RAL 9006 silver or RAL 9005 black - on request in RAL of choice. Diffuser either in PMMA opal or PMMA clear with inserted microprismatic plate for reduced luminance (UGR<19). The LED driver is integrated in the luminaire housing - either as on/off or DALI version. Colour temperatures 2700K, 3000K, 4000K or dynamic white (2700K-6500K) - colour rendering CRI>80 or CRI>90 - Mac Adam ≤3. Further control options or light colours available on request. In addition, the integration of many components, such as emergency lighting or sensor technology, as well as a variety of other options is possible.

Luminaire de surface LED encastré avec cadre périphérique à éclairage direct. Canal lumineux en profilé d'aluminium extrudé d'une largeur totale de 88 mm. Fabrication de la longueur du luminaire au millimètre près possible sur demande du client. Surface du luminaire à structure fine, revêtement par poudre mat similaire à RAL 9016 blanc, RAL 9006 argent ou RAL 9005 noir - sur demande en RAL au choix. Diffuseur au choix en PMMA opale ou en PMMA transparent avec plaque microprismatique insérée pour un éblouissement réduit (UGR<19). Le pilote LED est intégré dans le boîtier du luminaire - au choix sous forme de variante on/off ou DALI. Températures de couleur 2700K, 3000K, 4000K ou blanc dynamique (2700K-6500K) - Rendu des couleurs CRI>80 ou CRI>90 - Mac Adam ≤3. Autres options de commande ou couleurs de lumière disponibles sur demande. En outre, l'intégration de nombreux composants, tels que l'éclairage de secours ou la technologie de détection, une multitude d'autres options sont possibles.

ÜBERSICHT | OVERVIEW | VUE D'ENSEMBLE

TECHNICAL DATA

2700K / 3000K / 4000K / 2700-6500K

CRI>80 / CRI>90

MacAdam ≤ 3

up to 125 lm/W, up to 2.836 lm/m

on-off / DALI

direct

opal / microprism (UGR <19)

L80 B10 50.000h

HOUSING COLOUR

schwarz | black | noir
RAL 9005

silber | silver | argent
RAL 9006

weiß | white | blanc
RAL 9016



RAL colour of your choice



Integration of Multisensor



Welded mitre cuts



Integration of emergency light



Contact us for more options...

EINBAULEUCHE „LINE70“
RECESSED LUMINAIRE “LINE70”
LUMINAIRE ENCASTRABLE « LINE70 »

Bestellbeispiel | Example order | Exemple de commande
 3.152 mm, CRI>90, 4000K, **direct**, low output on/off, black, microprism

LI70E-319401-LOBLM

1 2 3 4 5 6

1 LÄNGE LENGTH LONGUEUR	
632 mm	06
992 mm	09
1.232 mm	12
1.472 mm	14
1.712 mm	17
1.952 mm	19
2.192 mm	21
2.432 mm	24
2.912 mm	29
3.152 mm	31
3.874 mm	38

2 FARBWIEDERGABE COLOUR RENDERING RENDU DES COULEURS	
CRI>80	8
CRI>90	9

3 FARBTEMPERATUR COLOUR TEMPERATURE TEMPÉRATURE DE COULEUR	
2700K (CRI>90 only)	27
3000K	30
4000K	40
2700-6500K (CRI>90 only)	DW

4 LEISTUNG & STEUERUNG OUTPUT & CONTROL SORTIE & CONTRÔLE	
low output on/off	LO
low output DALI	LD
high output on/off	HO
high output DALI	HD
dynamic white DALI DT8	DW

5 GEHÄUSEFARBE HOUSING COLOUR COULEUR DU BOÎTIER	
silver RAL 9006	SI
white RAL 9016	WH
black RAL 9005	BL

6 DIFFUSOR DIFFUSER DIFFUSEUR	
opal	O
microprism	M

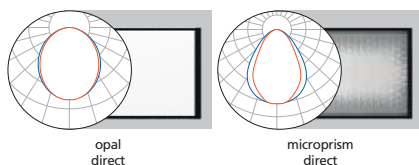
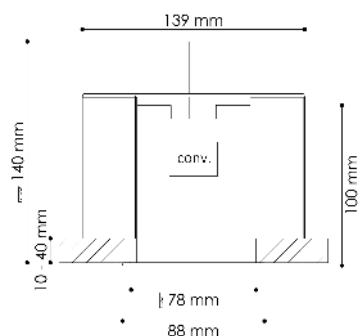

Size [mm]	low output		high output		kg
	[lm] / [W]	[lm] / [W]	[lm] / [W]	[lm] / [W]	
632	1.077 / 11,8	1.709 / 16,3	1.045 / 11,8	1.608 / 16,3	2,5
992	1.723 / 15,2	2.734 / 25,0	1.672 / 15,2	2.573 / 25,0	3,4
1.232	2.154 / 18,8	3.418 / 30,0	2.090 / 18,8	3.216 / 30,0	3,9
1.472	2.585 / 22,1	4.102 / 35,8	2.508 / 22,1	3.859 / 35,8	4,5
1.712	3.016 / 25,5	4.785 / 41,1	2.926 / 25,5	4.502 / 41,1	5,2
1.952	3.446 / 28,7	5.469 / 46,3	3.344 / 28,7	5.146 / 46,3	5,8
2.192	3.877 / 32,0	6.152 / 52,0	3.762 / 32,0	5.789 / 52,0	6,6
2.432	4.308 / 35,4	6.836 / 57,3	4.180 / 35,4	6.432 / 57,3	7,2
2.912	5.170 / 41,6	8.203 / 69,6	5.016 / 41,6	7.718 / 69,6	8,5
3.152	5.600 / 44,8	8.887 / 75,5	5.434 / 44,8	8.362 / 75,5	9,2
3.874	6.892 / 57,4	10.938 / 92,6	6.688 / 57,4	10.292 / 92,6	11,4



CUTOUT

Size [mm]	length [mm]	width [mm]	depth [mm]
632	624	78	140
992	984	78	140
1.232	1.224	78	140
1.472	1.464	78	140
1.712	1.704	78	140
1.952	1.944	78	140
2.192	2.184	78	140
2.432	2.424	78	140
2.912	2.904	78	140
3.152	3.144	78	140
3.874	3.866	78	140

Alle Lumenangaben für 4000K, CRI>80, Microprisma ohne Opalfolie
 All lumen values for 4000K, CRI>80, microprism without opal foil
 Toutes les données de lumens pour 4000K, CRI>80, microprisme sans feuille opale

RING50

EINBAULEUCHE | RECESSED LUMINAIRE | LUMINAIRE ENCASTRABLE

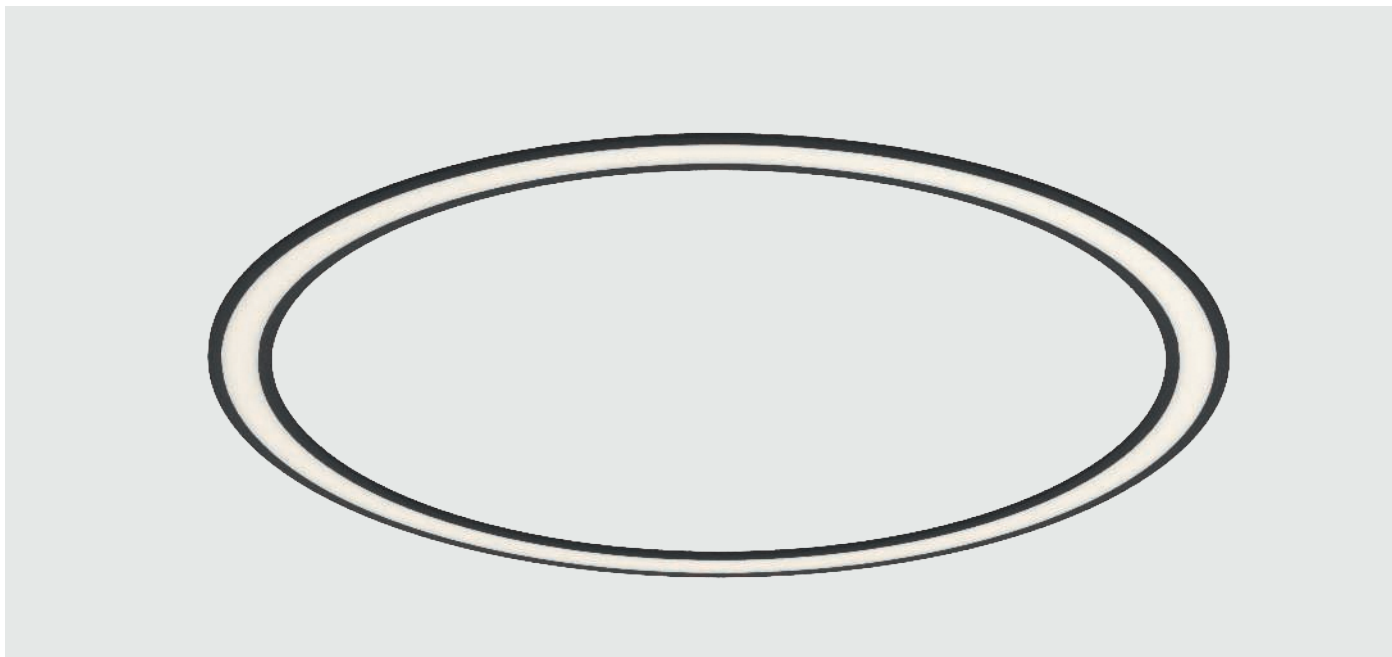

Ringförmige LED-Einbauleuchte mit umlaufendem Rahmen, direktstrahlend. Lichtkanal aus gerolltem Aluminiumprofil mit einer Gesamtbreite von 63 mm. Leuchte erhältlich in neun verschiedenen Durchmessern – 1233 und 1588 mm in einem Stück nahtlos verschweißt – die restlichen Größen (2033, 2608, 3103, 3548, 4083, 5063, 6088 mm) bestehend aus zwei bis neun gleich großen Segmenten. Oberfläche der Leuchte feinstruktur matt pulverbeschichtet ähnlich RAL 9016 weiß, RAL 9006 silber oder RAL 9005 schwarz – auf Anfrage in RAL nach Wahl. Diffusor wahlweise in PMMA opal oder PMMA klar mit mikroprismatischer Prägung für eine reduzierte Leuchtdichte (UGR<19). Der LED-Treiber ist im Leuchtgehäuse integriert – wahlweise als on/off oder DALI-Variante. Farbtemperaturen 2700K, 3000K, 4000K oder dynamisch Weiß (2700K–6500K) – Farbwiedergabe CRI>80 oder CRI>90 – Mac Adam ≤3. Weitere Steuerungsoptionen oder Lichtfarben auf Anfrage erhältlich. Außerdem ist die Integration vieler Komponenten, wie beispielsweise Notlicht oder Sensortechnologie, sowie eine Vielzahl weiterer Optionen möglich.

Ring-shaped recessed LED luminaire with surrounding frame, direct beam. Light channel made of rolled aluminium profile with a total width of 63 mm. Luminaire available in nine different diameters - 1233 and 1588 mm seamlessly welded in one piece - the remaining sizes (2033, 2608, 3103, 3548, 4083, 5063, 6088 mm) consisting of two to nine equally sized segments. Surface of the luminaire fine structure matt powder coated similar to RAL 9016 white, RAL 9006 silver or RAL 9005 black - on request in RAL of choice. Diffuser either in PMMA opal or PMMA clear with microprismatic pattern for reduced luminance (UGR<19). The LED driver is integrated in the luminaire housing - either as on/off or DALI version. Colour temperatures 2700K, 3000K, 4000K or dynamic white (2700K-6500K) - colour rendering CRI>80 or CRI>90 - Mac Adam ≤3. Further control options or light colours available on request. In addition, the integration of many components, such as emergency lighting or sensor technology, as well as a variety of other options is possible.

Luminaire LED encastré en forme d'anneau avec cadre périphérique, éclairage direct. Canal lumineux en profilé d'aluminium roulé d'une largeur totale de 63 mm. Luminaire disponible en neuf diamètres différents - 1233 et 1588 mm en une seule pièce soudée sans soudure - les autres tailles (2033, 2608, 3103, 3548, 4083, 5063, 6088 mm) se composent de deux à neuf segments de même taille. Surface du luminaire à structure fine matte revêtue par poudre similaire à RAL 9016 blanc, RAL 9006 argent ou RAL 9005 noir - sur demande en RAL au choix. Diffuseur au choix en PMMA opale ou en PMMA transparent avec gaufrage microprismatique pour un éblouissement réduit (UGR<19). Le driver LED est intégré dans le boîtier du luminaire - au choix en version on/off ou DALI. Températures de couleur 2700K, 3000K, 4000K ou blanc dynamique (2700K-6500K) - Rendu des couleurs CRI>80 ou CRI>90 - Mac Adam ≤3. Autres options de commande ou couleurs de lumière disponibles sur demande. En outre, l'intégration de nombreux composants, tels que l'éclairage de secours ou la technologie des capteurs, une multitude d'autres options sont possibles.

ÜBERSICHT | OVERVIEW | VUE D'ENSEMBLE

TECHNICAL DATA

2700K / 3000K / 4000K / 2700-6500K

CRI>80 / CRI>90

MacAdam ≤ 3

up to 131 lm/W

on-off / DALI

direct

opal / microprism (UGR <19)

L80 B10 50.000h

HOUSING COLOUR

schwarz | black | noir
RAL 9005

silber | silver | argent
RAL 9006

weiß | white | blanc
RAL 9016



RAL colour of your choice



Integration of emergency light



Contact us for more options...

EINBAULEUCHE „RING50“
RECESSED LUMINAIRE “RING50”
LUMINAIRE ENCASTRABLE « RING50 »

Bestellbeispiel | Example order | Exemple de commande
 6.088 mm, CRI>90, 4000K, **direct**, low output on/off, black, microprism

RG50E-609401-LOBLM

1 2 3 4 5 6

1 DURCHMESSER
DIFFUSER
DIFFUSEUR

1.233 mm (no DW)	12
1.588 mm (no DW)	15
2.033 mm	20
2.608 mm	26
3.103 mm	31
3.548 mm	35
4.083 mm	40
5.063 mm	50
6.088 mm	60

2 FARBWIEDERGABE
COLOUR RENDERING
RENDU DES COULEURS

CRI>80	8
CRI>90	9

3 FARBTEMPERATUR
COLOUR TEMPERATURE
TEMPÉRATURE DE COULEUR

2700K (CRI>90 only)	27
3000K	30
4000K	40
2700-6500K (CRI>90 only)	DW

4 LEISTUNG & STEUERUNG
OUTPUT & CONTROL
SORTIE & CONTRÔLE

low output on/off	LO
low output DALI	LD
high output on/off	HO
high output DALI	HD
dynamic white DALI DT8	DW

5 GEHÄUSEFARBE
HOUSING COLOUR
COULEUR DU BOÎTIER

silver RAL 9006	SI
white RAL 9016	WH
black RAL 9005	BL

6 DIFFUSOR
DIFFUSER
DIFFUSEUR

opal	O
microprism	M

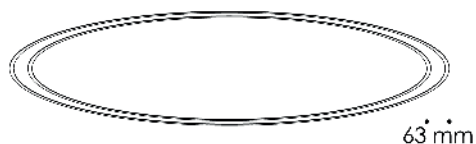

Ø 1233 / 1588 / 2033 / 2608 / 3103 /
 3548 / 4083 / 5063 / 6088 mm

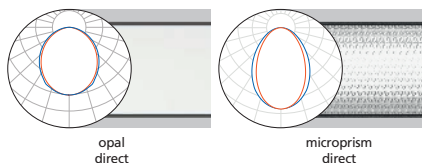
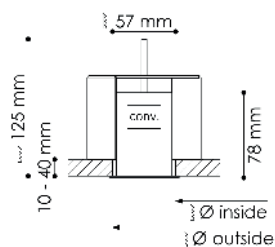

CUTOUT

Size [mm]	low output [lm] / [W]	high output [lm] / [W]	low output [lm] / [W]	high output [lm] / [W]	 [kg]
Ø 1.233	4.888 / 38,3	8.376 / 66,3	5.026 / 38,3	8.616 / 66,3	10,3
Ø 1.588	6.110 / 51,2	10.470 / 86,6	6.283 / 51,2	10.770 / 86,6	13,3
Ø 2.033	7.943 / 65,0	13.611 / 113,2	8.168 / 65,0	14.001 / 113,2	17,0
Ø 2.608	10.387 / 85,0	17.799 / 147,9	10.681 / 85,0	18.309 / 147,9	21,9
Ø 3.103	12.220 / 102,4	20.940 / 178,0	12.566 / 102,4	21.540 / 178,0	26,1
Ø 3.548	14.053 / 120,7	24.081 / 209,0	14.451 / 120,7	24.771 / 209,0	29,8
Ø 4.083	15.886 / 137,0	27.222 / 238,0	16.336 / 137,0	28.002 / 238,0	34,3
Ø 5.063	20.163 / 172,0	34.551 / 298,0	20.734 / 172,0	35.541 / 298,0	42,6
Ø 6.088	23.829 / 205,5	40.833 / 357,0	24.504 / 205,5	42.003 / 357,0	51,3

Size [mm]	inside [mm]	outside [mm]	depth [mm]
Ø 1.233	Ø 1.113	Ø 1.227	125
Ø 1.588	Ø 1.468	Ø 1.582	125
Ø 2.033	Ø 1.913	Ø 2.027	125
Ø 2.608	Ø 2.488	Ø 2.602	125
Ø 3.103	Ø 2.983	Ø 3.097	125
Ø 3.548	Ø 3.428	Ø 3.542	125
Ø 4.083	Ø 3.963	Ø 4.077	125
Ø 5.063	Ø 4.943	Ø 5.057	125
Ø 6.088	Ø 5.968	Ø 6.082	125

Alle Lumenangaben für 4000K, CRI>80, Gehäusefarbe weiß
 All lumen values for 4000K, CRI>80, housing colour white
 Toutes les données de lumens pour 4000K, CRI>80, couleur du boîtier blanc

FLEX50

EINBAULEUCHE | RECESSED LUMINAIRE | LUMINAIRE ENCASTRABLE



LED-Einbauleuchte als Segment zur individuellen Kombination. Direktstrahlend. Lichtkanal aus gerolltem Aluminiumprofil mit einer Breite von 63 mm. Segmente erhältlich in 13 verschiedenen Varianten – zwei Stück als gerades Profil 980 oder 1960 mm – die restlichen Segmente sind als 40°, 45°, 60°- bzw. 90°-Stücke mit einem Mittenradius von 585 bis 3012,5 mm erhältlich. Oberfläche der Leuchte feinstruktur matt pulverbeschichtet ähnlich RAL 9016 weiß, RAL 9006 silber oder RAL 9005 schwarz – auf Anfrage in RAL nach Wahl. Diffusor wahlweise in PMMA opal oder PMMA mit mikroprismatischer Prägung für eine reduzierte Leuchtdichte (UGR<19). Der LED-Treiber ist im Leuchtgehäuse integriert – wahlweise als on/off oder DALI-Variante. Farbtemperaturen 2700K, 3000K, 4000K oder dynamisch Weiß (2700K–6500K) – Farbwiedergabe CRI>80 oder CRI>90 – Mac Adam ≤3. Weitere Steuerungsoptionen oder Lichtfarben auf Anfrage erhältlich. Außerdem ist die Integration vieler Komponenten, wie beispielsweise Notlicht oder Sensortechnologie, sowie eine Vielzahl weiterer Optionen möglich.

Recessed LED luminaire as segment for individual combination. Direct beam. Light channel made of rolled aluminium profile with a width of 63 mm. Segments available in 13 different versions - two pieces as straight profile 980 or 1960 mm - the remaining segments are available as 40°, 45°, 60° or 90° pieces with a middle radius of 585 to 3012.5 mm. Surface of the luminaire fine structure matt powder coated similar to RAL 9016 white, RAL 9006 silver or RAL 9005 black - on request in RAL of choice. Diffuser either in PMMA opal or PMMA clear with microprismatic pattern for reduced luminance (UGR<19). The LED driver is integrated in the luminaire housing - either as on/off or DALI version. Colour temperatures 2700K, 3000K, 4000K or dynamic white (2700K-6500K) - colour rendering CRI>80 or CRI>90 - Mac Adam ≤3. Further control options or light colours available on request. In addition, the integration of many components, such as emergency lighting or sensor technology, as well as a variety of other options is possible.

Luminaire LED encastré a segment pour une combinaison individuelle. Éclairage direct de la surface. Canal lumineux en profilé d'aluminium roulé d'une largeur de 63 mm. Segments disponibles en 13 variantes différentes - deux pièces sous forme de profilé droit de 980 ou 1960 mm - les autres segments sont disponibles sous forme de pièces de 40°, 45°, 60° ou 90° avec un rayon central de 585 à 3012,5 mm. Surface du luminaire à structure fine matte revêtue par poudre similaire à RAL 9016 blanc, RAL 9006 argent ou RAL 9005 noir - sur demande en RAL au choix. Diffuseur au choix en PMMA opale ou en PMMA transparent avec gaufrage microprismatique pour un éblouissement réduit (UGR<19). Le pilote LED est intégré dans le boîtier du luminaire - au choix sous forme de variante on/off ou DALI. Températures de couleur 2700K, 3000K, 4000K ou blanc dynamique (2700K-6500K) - Rendu des couleurs CRI>80 ou CRI>90 - Mac Adam ≤3. Autres options de commande ou couleurs de lumière disponibles sur demande. En outre, l'intégration de nombreux composants, tels que l'éclairage de secours ou la technologie de détection, une multitude d'autres options sont possibles.

ÜBERSICHT | OVERVIEW | VUE D'ENSEMBLE

TECHNICAL DATA

2700K / 3000K / 4000K / 2700-6500K

CRI>80 / CRI>90

MacAdam ≤ 3

up to 119 lm/W

on-off / DALI

direct

opal / microprism (UGR <19)

L80 B10 50.000h

HOUSING COLOUR

schwarz | black | noir
RAL 9005

silber | silver | argent
RAL 9006

weiß | white | blanc
RAL 9016



LED



>50.000h

3
SDCM

IP
20

CE

UK
CA



RAL colour of your choice



Integration of emergency light



Contact us for more options...

EINBAULEUCHE „FLEX50“
RECESSED LUMINAIRE “FLEX50”
LUMINAIRE ENCASTRABLE « FLEX50 »

Bestellbeispiel | Example order | Exemple de commande
 straight, 1.960 mm, CRI>90, 4000K, **direct**, low output on/off, black, microprism

FX50E-L29401-LOBLM

1 2 3 4 5 6

1 GRÖSSE SIZE TAILLE		
straight, L 980 mm	L1	
straight, L 1.960 mm	L2	
90°, R 585 mm (no DW)	19	
90°, R 762,5 mm (no DW)	29	
90°, R 985 mm	39	
45°, R 1.272,5 mm	44	
90°, R 1.272,5 mm	49	
60°, R 1.520 mm	56	
90°, R 1.520 mm	59	
60°, R 1.742,5 mm	66	
60°, R 2.010 mm	76	
45°, R 2.500 mm	84	
40°, R 3.012,5 mm	94	

2 FARBWIEDERGABE COLOUR RENDERING RENDU DES COULEURS		
CRI>80		8
CRI>90		9

3 FARBTEMPERATUR COLOUR TEMPERATURE TEMPÉRATURE DE COULEUR		
2700K (CRI>90 only)		27
3000K		30
4000K		40
2700-6500K (CRI>90 only)		DW

4 LEISTUNG & STEUERUNG OUTPUT & CONTROL SORTIE & CONTRÔLE		
low output on/off		LO
low output DALI		LD
high output on/off		HO
high output DALI		HD
dynamic white DALI DT8		DW

5 GEHÄUSEFARBE HOUSING COLOUR COULEUR DU BOÎTIER		
silver RAL 9006		SI
white RAL 9016		WH
black RAL 9005		BL

6 DIFFUSOR DIFFUSER DIFFUSEUR		
opal		O
microprism		M

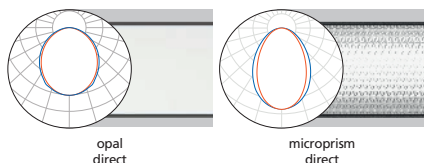
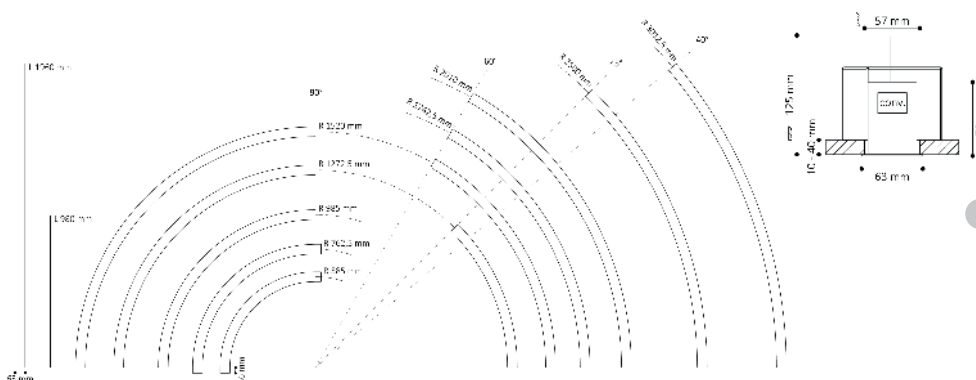

ACCESSORIES		
END CAPS - 2 pcs.		
black		FX50E-EC-BL
silver		FX50E-EC-SI
white		FX50E-EC-WH

Size [mm]	opal direct		microprism direct		kg
	low output [lm] / [W]	high output [lm] / [W]	low output [lm] / [W]	high output [lm] / [W]	
straight, L 980	1.222 / 11,2	2.094 / 18,1	1.257 / 11,2	2.153 / 18,1	2,6
straight, L 1.960	2.554 / 23,3	4.377 / 37,8	2.626 / 23,3	4.377 / 37,8	5,3
90°, R 585	1.224 / 9,6	2.096 / 16,6	1.256 / 9,6	2.156 / 16,6	2,6
90°, R 762,5	1.530 / 12,8	2.620 / 21,6	1.570 / 12,8	2.695 / 21,6	3,3
90°, R 985	1.836 / 16,3	3.144 / 28,3	1.884 / 16,3	3.234 / 28,3	4,3
45°, R 1.272,5	1.224 / 10,6	2.096 / 18,5	1.256 / 10,6	2.156 / 18,5	2,7
90°, R 1.272,5	2.448 / 21,3	4.192 / 37,0	2.512 / 21,3	4.312 / 37,0	5,5
60°, R 1.520	1.836 / 17,1	3.144 / 29,6	1.884 / 17,1	3.234 / 29,6	4,3
90°, R 1.520	3.060 / 25,6	5.240 / 44,5	3.140 / 25,6	5.390 / 44,5	6,5
60°, R 1.742,5	2.142 / 20,1	3.668 / 34,8	2.198 / 20,1	3.773 / 34,8	5,0
60°, R 2.010	2.754 / 22,8	4.716 / 39,7	2.826 / 22,8	4.851 / 39,7	5,7
45°, R 2.500	2.448 / 21,5	4.192 / 37,2	2.512 / 21,5	4.312 / 37,2	5,3
40°, R 3.012,5	2.754 / 22,8	4.716 / 39,7	2.826 / 22,8	4.851 / 39,7	5,7



CUTOUT

Size [mm]	width [mm]	depth [mm]
	57	125

Alle Lumenangaben für 4000K, CRI>80, Gehäusefarbe weiß
 All lumen values for 4000K, CRI>80, housing colour white
 Toutes les données de lumens pour 4000K, CRI>80, couleur du boîtier blanc

ROUND90

Einbauleuchte | Recessed luminaire | Luminaire encastrable



Runde LED-Flächenleuchte zur Einbaumontage. Direktstrahlend mit umlaufendem Rahmen. Gehäuse und Einbaurahmen aus gerolltem Aluminiumprofil, nahtlos verschweißt. Fertigung der Leuchte inkl. Rahmen in vier Durchmessern: 380, 480, 680 und 980 mm mit einer Gesamthöhe von 93 mm. Benötigte Einbauhöhe 120mm. Oberfläche pulverbeschichtet feinststruktur matt ähnlich RAL 9016 weiß, RAL 9006 silber oder RAL 9005 schwarz – auf Anfrage in RAL nach Wahl. Die durchdachte Konstruktion der Leuchte ermöglicht ein Design in zahlreichen Farbkombinationen – zwischen Gehäusefarbe und Dekorring kann beliebig kombiniert werden. Um der Leuchtenfamilie neben den Standardfarben einen dekorativen Touch zu verleihen, steht der Dekorring auch in den strukturierten Spezialoberflächen schlaggold, schlagsilber und schlagbronze zur Auswahl. Diffusor in PMMA wahlweise opal, mikroprismatisch inkl. Streufole oder nur mikroprismatisch (office special) für eine reduzierte Leuchtdichte (UGR<19). Einfache Montage der Leuchte in den Einbaurahmen (separate Einheit) durch Einsetzen und Drehen. Der LED-Treiber wird als Einwurf-Gerät inkl. Zugentlastung mitgeliefert – wahlweise als on/off oder DALI-Variante. Farbtemperaturen 2700K, 3000K, 4000K oder dynamisch Weiß (2700K–6500K) – Farbwiedergabe CRI>80 oder CRI>90 – Mac Adam ≤3. Weitere Steuerungsoptionen oder Lichtfarben auf Anfrage möglich. Außerdem ist die Integration vieler Komponenten, wie beispielsweise Notlicht oder Sensortechnologie, sowie eine Vielzahl weiterer Optionen möglich.

Round LED luminaire for recessed mounting. Direct beam with surrounding frame. Housing and mounting frame made of rolled aluminium profile, seamlessly welded. Manufacture of luminaire incl. frame in four diameters: 380, 480, 680 and 980 mm with a total height of 93 mm. Required installation height 120mm. Surface powder coated fine structure matt similar to RAL 9016 white, RAL 9006 silver or RAL 9005 black - on request in RAL of your choice. The sophisticated construction of the luminaire allows a design in numerous colour combinations - any combination of housing colour and decorative ring is possible. To give the luminaire family a decorative touch in addition to the standard colours, the decorative ring is also available in the special textured surfaces beaten gold, beaten silver and beaten bronze. Diffuser in PMMA either opal, microprism incl. diffuser foil or only microprism (office special) for reduced luminance (UGR<19). Easy mounting of the luminaire in the mounting frame (separate unit) by inserting and turning. The LED driver is supplied as a throw-in unit incl. strain relief - either as on/off or DALI version. Colour temperatures 2700K, 3000K, 4000K or dynamic white (2700K-6500K) - colour rendering CRI>80 or CRI>90 - Mac Adam ≤3. Further control options or light colours available on request. In addition, the integration of many components, such as emergency lighting or sensor technology, as well as a variety of other options is possible.

Luminaire rond LED encastré. Éclairage direct avec cadre périphérique. Boîtier et cadre d'encastrement en profilé d'aluminium roulé, soudé sans soudure. Fabrication du luminaire, cadre inclus, en quatre diamètres : 380, 480, 680 et 980 mm avec une hauteur totale de 93 mm. Hauteur d'encastrement nécessaire : 120 mm. Surface revêtue par poudre, structure fine mate similaire à RAL 9016 blanc, RAL 9006 argent ou RAL 9005 noir - sur demande en RAL au choix. La construction bien pensée du luminaire permet un design dans de nombreuses combinaisons de couleurs - il est possible de combiner à volonté entre la couleur du boîtier et l'anneau décoratif. Pour donner à la famille de luminaires une touche décorative en plus des couleurs standard, l'anneau décoratif est également disponible dans les surfaces spéciales structurées or choc, argent choc et bronze choc. Diffuseur en PMMA au choix opale, microprismatique y compris feuille diffuseuse ou uniquement microprismatique (office special) pour un éblouissement réduit (UGR<19). Montage simple du luminaire dans le cadre d'encastrement (unité séparée) en l'insérant et en le tournant. Le driver LED est fourni sous forme d'appareil à insérer, décharge de traction incluse - au choix en version on/off ou DALI. Températures de couleur 2700K, 3000K, 4000K ou blanc dynamique (2700K-6500K) - Rendu des couleurs CRI>80 ou CRI>90 - Mac Adam ≤3. Autres options de commande ou couleurs de lumière possibles sur demande. En outre, l'intégration de nombreux composants, tels que l'éclairage de secours ou la technologie des capteurs, une multitude d'autres options sont possibles.

ÜBERSICHT | OVERVIEW | VUE D'ENSEMBLE

TECHNICAL DATA
2700K / 3000K / 4000K / 2700-6500K
CRI>80 / CRI>90
MacAdam ≤ 3
up to 174 lm/W
on-off / DALI
direct / direct + indirect
opal / microprism / office special (UGR <19)
L80 B10 50.000h

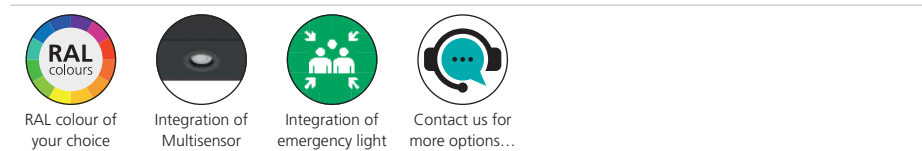

HOUSING COLOUR	
schwarz black noir RAL 9005	
silber silver argent RAL 9006	
weiß white blanc RAL 9016	

DECORATION RING COLOUR			
schwarz black noir RAL 9005		schlaggold beaten gold or texturés	
silber silver argent RAL 9006		schlagsilber beaten silver argent texturés	
weiß white blanc RAL 9016		schlagbronze beaten bronze bronze texturés	

EINBAULEUCHE „ROUND90“
RECESSED LUMINAIRE “ROUND90”
LUMINAIRE ENCASTRABLE « ROUND90 »

Bestellbeispiel | Example order | Exemple de commande
 380 mm, CRI>90, 4000K, **direct**, low output on/off, black, beaten gold, microprism

RO90E-359401-LOBGM

1 2 3 4 5 6 7

1	DURCHMESSER DIAMETER DIAMÈTRE	
	380 mm	35
	480 mm	45
	680 mm	65
	980 mm	95
2	FARBWIEDERGABE COLOUR RENDERING RENDU DES COULEURS	
	CRI>80	8
	CRI>90	9
3	FARBTEMPERATUR COLOUR TEMPERATURE TEMPÉRATURE DE COULEUR	
	2700K (CRI>90 only)	27
	3000K	30
	4000K	40
	2700-6500K (CRI>90 only)	DW

4	LEISTUNG & STEUERUNG OUTPUT & CONTROL SORTIE & CONTRÔLE	
	low output on/off	LO
	low output DALI	LD
	high output on/off	HO
	high output DALI	HD
	dynamic white DALI DT8	DW

5	GEHÄUSEFARBE HOUSING COLOUR COULEUR DU BOÎTIER	
	black RAL 9005	B
	silver RAL 9006	S
	white RAL 9016	W

6	DEKORRING FARBE DECORATION RING COLOUR BAGUE DÉCORATIVE COULEUR	
	black RAL 9005	B
	silver RAL 9006	S
	white RAL 9016	W
	beaten gold	G
	beaten silver	A
	beaten bronze	C

7	DIFFUSOR DIFFUSER DIFFUSEUR	
	opal	O
	microprism	M
	office special	B

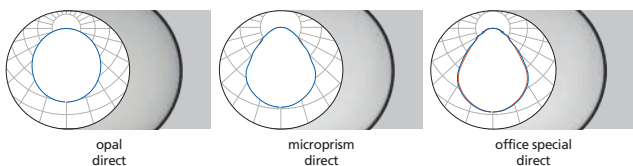
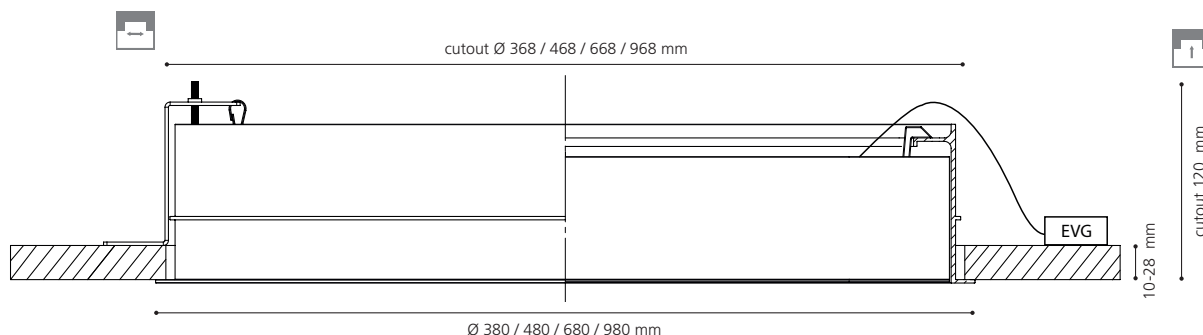

Size [mm]	low output [lm] / [W]	high output [lm] / [W]	low output [lm] / [W]	high output [lm] / [W]	low output [lm] / [W]	high output [lm] / [W]	KG
Ø 380	1.158 / 8,5	1.826 / 12,9	1.077 / 8,5	1.697 / 12,9	1.213 / 8,5	1.905 / 12,9	3,7
Ø 480	2.258 / 15,5	3.561 / 23,5	2.099 / 15,5	3.309 / 23,5	2.364 / 15,5	3.715 / 23,5	5,2
Ø 680	4.114 / 27,2	6.489 / 41,3	3.825 / 27,2	6.029 / 41,3	4.309 / 27,2	6.770 / 41,3	8,9
Ø 980	9.102 / 56,7	14.360 / 86,0	8.466 / 56,7	13.342 / 86,0	9.535 / 56,7	14.982 / 86,0	15,5



CUTOUT

Size [mm]	diameter [mm]	depth [mm]
Ø 380	Ø 368	120
Ø 480	Ø 468	120
Ø 680	Ø 668	120
Ø 980	Ø 968	120

Alle Lumenangaben für 4000K, CRI>80, Gehäusefarbe weiß
 All lumen values for 4000K, CRI>80, housing colour white
 Toutes les données de lumens pour 4000K, CRI>80, couleur du boîtier blanc

DOWN75

Einbauleuchte | Recessed Luminaire | Luminaire Encastrable

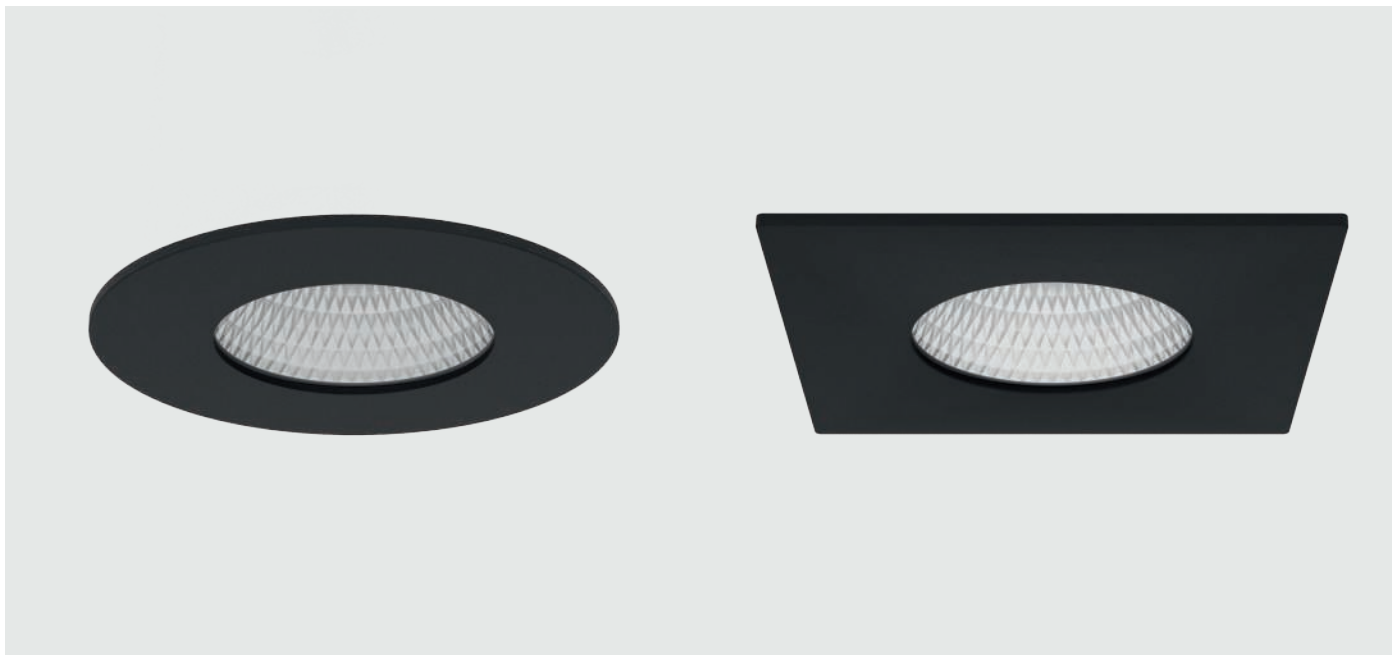

Runder und quadratischer LED-Einbaustrahler direktstrahlend in der Größe Ø75mm bzw 75mm x 75mm für den Deckenausschnitt von Ø65mm. Leuchte aus Aluminium-Druckguss. Oberfläche der Leuchte feinstruktur matt pulverbeschichtet ähnlich RAL 9016 weiß, ähnlich RAL 9005 schwarz oder ähnlich RAL 9006. Leistungsstarke Downlightserie mit zwei verschiedenen Leistungsstufen - low Output (Einbautiefe: 80mm) oder high Output (Einbautiefe: 100mm). Zwei verschiedene Abstrahlcharakteristiken mit 23° und 45° wählbar. Die Leuchte ist inkl. LED-Treiber – on/off, TRIAC oder DALI – bestellbar. Farbtemperaturen 2700K, 3000K oder 4000K – Farbwiedergabe CRI>90 – Mac Adam ≤3. Weitere Optionen und Konfigurationen auf Anfrage möglich.

Round and square LED recessed downlight with direct beam in the size Ø75mm or 75mm x 75mm for the ceiling cut-out of Ø65mm. Luminaire made of die-cast aluminum. Surface of the luminaire fine structure matt powder-coated similar to RAL 9016 white, similar to RAL 9005 black or similar to RAL 9006. Powerful downlight series with two different output levels - low output (installation depth: 80mm) or high output (installation depth: 100mm). Two different beam characteristics with 23° and 45° selectable. The luminaire can be ordered including LED driver - on/off, TRIAC or DALI. Color temperatures 2700K, 3000K or 4000K - color rendering CRI>90 - Mac Adam ≤3. Further options and configurations available on request.

Spot LED encastré rond et carré à émission directe de Ø75mm ou 75mm x 75mm pour une découpe de plafond de Ø65mm. Luminaire en aluminium moulé sous pression. Surface du luminaire revêtue de poudre à structure fine mate similaire à RAL 9016 blanc, similaire à RAL 9005 noir ou similaire à RAL 9006. Série de downlights puissants avec deux niveaux de puissance différents - low output (profondeur d'encastrement : 80mm) ou high output (profondeur d'encastrement : 100mm). Deux caractéristiques de rayonnement différentes avec 23° et 45° au choix. Le luminaire peut être commandé avec un pilote LED - on/off, TRIAC ou DALI. Températures de couleur 2700K, 3000K ou 4000K - Rendu des couleurs CRI>90 - Mac Adam ≤3. Autres options et configurations possibles sur demande.

ÜBERSICHT | OVERVIEW | VUE D'ENSEMBLE

TECHNICAL DATA

2700K / 3000K / 4000K

CRI>90

MacAdam ≤ 3

on-off / DALI / TRIAC

beam angle: 23° / 45°

L80 B10 50.000h



RAL colour of your choice



Contact us for more options...

HOUSING COLOUR

schwarz | black | noir
RAL 9005



silber | silver | argent
RAL 9006



weiß | white | blanc
RAL 9016



EINBAULEUCHE „DOWN75“
RECESSED LUMINAIRE “DOWN75”
LUMINAIRE ENCASTRABLE « DOWN75 »

Bestellbeispiel | Example order | Exemple de commande
 Ø 75 mm, 23°, **CR190**, 4000K, **direct**, incl. driver on/off low output, black, **silver specular**

DWD7E-239401-LOBLS

- 1 2 3 4 5

1 **ABMESSUNG**
 DIMENSIONS
 DIMENSIONS

Ø 75 mm	D7
□ 75 x 75 mm	S7

2 **ABSTRAHLWINKEL**
 BEAM ANGLE
 ANGLE DE DIFFUSION

23°	23
45°	45

3 **FARBTEMPERATUR**
 COLOUR TEMPERATURE
 TEMPÉRATURE DE COULEUR

2700K	27
3000K	30
4000K	40

4 **LEISTUNG & STEUERUNG**
 OUTPUT & CONTROL
 SORTIE & CONTRÔLE

incl. driver on/off low output	LO
incl. driver DALI low output	LD
incl. driver TRIAC low output	LT
incl. driver TRIAC high output	HT
incl. driver on/off high output	HO
incl. driver DALI high output	HD

5 **GEHÄUSEFARBE**
 HOUSING COLOUR
 COULEUR DU BOÎTIER

white RAL 9016	WH
black RAL 9005	BL
silver RAL 9006	SI

square low output

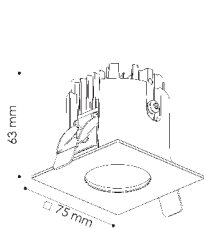

square high output

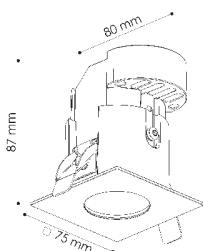

round low output

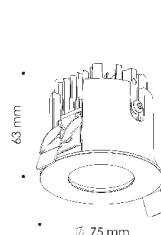

round high output

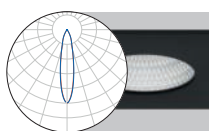
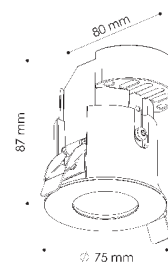

23°

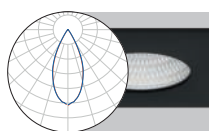

45°

low output

high output

Size [mm]	low output [lm] / [W]	high output [lm] / [W]	low output [lm] / [W]	high output [lm] / [W]	[kg]	[kg]
Ø 75	957 / 10,5	1.330 / 14,2	959 / 10,5	1.341 / 14,2	0,30	0,45
□ 75 x 75	957 / 10,5	1.330 / 14,2	959 / 10,5	1.341 / 14,2	0,30	0,45



CUTOUT

Size [mm]	diameter [mm]	depth low [mm]	depth high [mm]
Ø 75	Ø 68	80	100
□ 75 x 75	Ø 68	80	100

Alle Lumenangaben für 4000K, CRI>90
 All lumen values for 4000K, CRI>90
 Toutes les données de lumens pour 4000K, CRI>90



Runder LED-Einbaustrahler direktstrahlend. Leuchte aus Aluminium-Druckguss mit einer Einbautiefe von 148 bzw. 171 mm. Durch den modularen Aufbau dieser Strahler-Familie gibt es die Leuchte wahlweise mit einem Durchmesser von 78 mm (Ausschnitt 68 mm) oder 110 mm (Ausschnitt 100 mm). Oberfläche der Leuchte feinstruktur matt pulverbeschichtet ähnlich RAL 9016 weiß oder ähnlich RAL 9005 schwarz. Das Baukasten-system ermöglicht das Auswählen von vier bzw. fünf unterschiedlichen Reflektoren: silber-hochglanz, silber-matt, schwarz-matt, gold-matt sowie silber-matt asymmetrisch für die Größe 110 mm. Die Leuchte kann wahlweise ohne Betriebsgerät oder inkl. LED-Treiber – on/off oder DALI – bestellt werden. Farbtemperaturen 2700K, 3000K oder 4000K – Farbwiedergabe CRI>90 – Mac Adam ≤3. Weitere Optionen und Konfigurationen auf Anfrage möglich.

Round recessed LED spotlight with direct beam. Luminaire made of die-cast aluminium with a mounting depth of 148 or 171 mm. Due to the modular design of this spotlight family, the luminaire is available either with a diameter of 78 mm (cut-out 68 mm) or 110 mm (cut-out 100 mm). Surface of the luminaire fine structure matt powder coated similar to RAL 9016 white or similar to RAL 9005 black. The modular system allows the selection of four or five different reflectors: silver specular, silver matt, black matt, gold matt as well as silver matt asymmetrical for the 110 mm size. The luminaire can be ordered either without power supply unit or incl. LED driver - on/off or DALI. Colour temperatures 2700K, 3000K or 4000K - colour rendering CRI>90 - Mac Adam ≤3. Further options and configurations available on request.

Spot LED rond à encastrer à éclairage direct. Luminaire en aluminium moulé sous pression avec une profondeur d'encastrement de 148 ou 171 mm. Grâce à la structure modulaire de cette famille de projecteurs, le luminaire est disponible au choix avec un diamètre de 78 mm (découpe de 68 mm) ou de 110 mm (découpe de 100 mm). La surface du luminaire est revêtue d'une structure fine mate, similaire au RAL 9016 blanc ou au RAL 9005 noir. Le système modulaire permet de choisir entre quatre ou cinq réflecteurs différents : argent brillant, argent mat, noir mat, or mat ainsi qu'argent mat asymétrique pour la taille 110 mm. Le luminaire peut être commandé au choix sans appareillage ou avec un pilote LED - on/off ou DALI. Températures de couleur 2700K, 3000K ou 4000K - Rendu des couleurs CRI>90 - Mac Adam ≤3. Autres options et configurations possibles sur demande.

ÜBERSICHT | OVERVIEW | VUE D'ENSEMBLE

TECHNICAL DATA

2700K / 3000K / 4000K

CRI>90

MacAdam ≤ 3

on-off / DALI

beam angle: 50° / 55° / asymmetric

L80 B10 50.000h



Contact us for more options...

HOUSING COLOUR

schwarz | black | noir
RAL 9005



weiß | white | blanc
RAL 9016



DECORATION RING COLOUR

silber hochglanz | silver specular |
argenté brillant



schwarz matt | black matt | noir mat



silber matt | silver matt | argenté mat



gold matt | gold matt | doré mat



EINBAULEUCHE „designDOT“
RECESSED LUMINAIRE “designDOT”
LUMINAIRE ENCASTRABLE « designDOT »

Bestellbeispiel | Example order | Exemple de commande
 78 mm, 55°, CRI>90, 4000K, direct, excl. driver, black, silver matt

DD68E-559401-OOBLM

1 2 3 4 5 6

1	DURCHMESSER	
	DIAMETER	
	DIAMÈTRE	
	78 mm	68
	110 mm	10

2	ABSTRAHLWINKEL	
	BEAM ANGLE	
	ANGLE DE DIFFUSION	
	50° (110 mm only)	50
	55° (78 mm only)	55
	asymmetric (110 mm only)	AA

3	FARBTEMPERATUR	
	COLOUR TEMPERATURE	
	TEMPÉRATURE DE COULEUR	
	2700K	27
	3000K	30
	4000K	40

4	LEISTUNG & STEUERUNG	
	OUTPUT & CONTROL	
	SORTIE & CONTRÔLE	
	excl. driver	NN
	incl. driver on/off	OO
	incl. driver DALI	DD

5	GEHÄUSEFARBE	
	HOUSING COLOUR	
	COULEUR DU BOÎTIER	
	white RAL 9016	WH
	black RAL 9005	BL

6	REFLEKTOR FARBE	
	REFLECTOR COLOUR	
	COULEUR DU RÉFLECTEUR	
	silver specular	S
	silver matt	M
	black matt	B
	gold matt	G
	asymmetric (110 mm only)	A

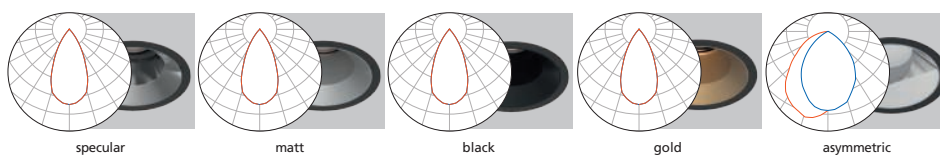
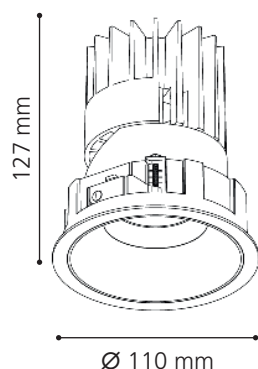
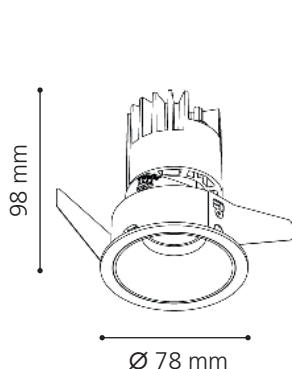

Size [mm]	specular single output [lm] / [W]	matt single output [lm] / [W]	black single output [lm] / [W]	gold single output [lm] / [W]	asymmetric single output [lm] / [W]	 [kg]
Ø 78	873 / 13,0	860 / 13,0	869 / 13,0	873 / 13,0	-	0,5
Ø 110	1.382 / 20,0	1.389 / 20,0	1.389 / 20,0	1.382 / 20,0	553 / 20,0	0,8



CUTOUT

Size [mm]	diameter [mm]	depth [mm]
Ø 78	Ø 68	148
Ø 110	Ø 100	171

Alle Lumenangaben für 4000K
 All lumen values for 4000K
 Toutes les données de lumens pour 4000K



Quadratischer LED-Einbaustrahler direktstrahlend. Leuchte aus Aluminium-Druckguss mit einer Einbautiefe von 148 bzw. 171 mm. Durch den modularen Aufbau dieser Strahler-Familie gibt es die Leuchte wahlweise mit den Abmessungen 78x78 mm (Ausschnitt 68x68 mm) oder 107x107 mm (Ausschnitt 96x96 mm). Oberfläche der Leuchte feinstruktur matt pulverbeschichtet ähnlich RAL 9016 weiß oder ähnlich RAL 9005 schwarz. Das Baukastensystem ermöglicht das Auswählen von vier bzw. fünf unterschiedlichen Reflektoren: silberhochglanz, silber-matt, schwarz-matt, gold-matt sowie silber-matt asymmetrisch für die Größe 107x107 mm. Die Leuchte kann wahlweise ohne Betriebsgerät oder inkl. LED-Treiber – on/off oder DALI – bestellt werden. Farbtemperaturen 2700K, 3000K oder 4000K – Farbwiedergabe CRI>90 – Mac Adam ≤3. Weitere Optionen und Konfigurationen auf Anfrage möglich.

Square recessed LED spotlight with direct beam. Luminaire made of die-cast aluminium with a mounting depth of 148 or 171 mm. Due to the modular design of this spotlight family, the luminaire is available either with the dimensions 78x78 mm (cut-out 68x68 mm) or 107x107 mm (cut-out 96x96 mm). Surface of the luminaire fine structure matt powder coated similar to RAL 9016 white or similar to RAL 9005 black. The modular system allows the selection of four or five different reflectors: silver specular, silver matt, black matt, gold matt as well as silver matt asymmetrical for the size 107x107 mm. The luminaire can be ordered either without power supply unit or incl. LED driver - on/off or DALI. Colour temperatures 2700K, 3000K or 4000K - colour rendering CRI>90 - Mac Adam ≤3. Further options and configurations available on request.

Spot LED encastré carré à éclairage direct. Luminaire en aluminium moulé sous pression avec une profondeur d'encastrément de 148 ou 171 mm. Grâce à la structure modulaire de cette famille de projecteurs, le luminaire est disponible au choix dans les dimensions 78x78 mm (découpe 68x68 mm) ou 107x107 mm (découpe 96x96 mm). La surface du luminaire est revêtue d'une structure fine mate, similaire au RAL 9016 blanc ou au RAL 9005 noir. Le système modulaire permet de choisir entre quatre ou cinq réflecteurs différents : argent brillant, argent mat, noir mat, or mat ainsi qu'argent mat asymétrique pour la taille 107x107 mm. Le luminaire peut être commandé au choix sans appareillage ou avec un pilote LED - on/off ou DALI. Températures de couleur 2700K, 3000K ou 4000K - Rendu des couleurs CRI>90 - Mac Adam ≤3. Autres options et configurations possibles sur demand.

ÜBERSICHT | OVERVIEW | VUE D'ENSEMBLE

TECHNICAL DATA

2700K / 3000K / 4000K

CRI>90

MacAdam ≤ 3

on-off / DALI

beam angle: 50° / 55° / asymmetric

L80 B10 50.000h



Contact us for more options...

HOUSING COLOUR

schwarz | black | noir
RAL 9005



weiß | white | blanc
RAL 9016



DECORATION RING COLOUR

silber hochglanz | silver specular |
argenté brillant



schwarz matt | black matt | noir mat



silber matt | silver matt | argenté mat



gold matt | gold matt | doré mat



EINBAULEUCHE „designSQOT“
RECESSED LUMINAIRE „designSQOT“
LUMINAIRE ENCASTRABLE « designSQOT »

Bestellbeispiel | Example order | Exemple de commande
 78 x 78 mm, 55°, CRI>90, 4000K, **direct**, excl. driver, black, silver matt

DS68E-559401-OOBLM

1 2 3 4 5 6

1 GRÖSSE
 SIZE
 TAILLE

78 x 78 mm	68
107 x 107 mm	10

2 ABSTRAHLWINKEL
 BEAM ANGLE
 ANGLE DE DIFFUSION

50° (107 mm only)	50
55° (78 mm only)	55
asymmetric (107 mm only)	AA

3 FARBTEMPERATUR
 COLOUR TEMPERATURE
 TEMPÉRATURE DE COULEUR

2700K	27
3000K	30
4000K	40

4 LEISTUNG & STEUERUNG
 OUTPUT & CONTROL
 SORTIE & CONTRÔLE

excl. driver	NN
incl. driver on/off	OO
incl. driver DALI	DD

5 GEHÄUSEFARBE
 HOUSING COLOUR
 COULEUR DU BOÎTIER

white RAL 9016	WH
black RAL 9005	BL

6 REFLEKTOR FARBE
 REFLECTOR COLOUR
 COULEUR DU RÉFLECTEUR

silver specular	S
silver matt	M
black matt	B
gold matt	G
asymmetric (107 mm only)	A

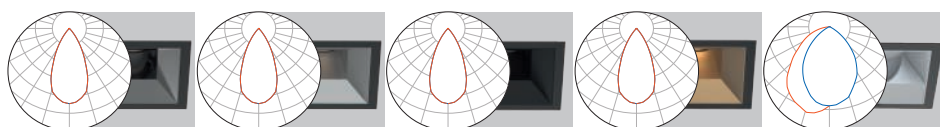
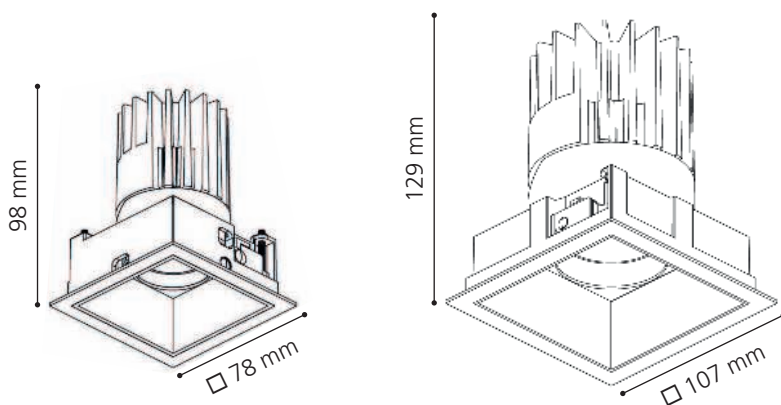

Size [mm]	specular single output [lm] / [W]	matt single output [lm] / [W]	black single output [lm] / [W]	gold single output [lm] / [W]	asymmetric single output [lm] / [W]	 [kg]
□ 78	873 / 13,0	860 / 13,0	869 / 13,0	873 / 13,0	-	0,5
□ 107	1.382 / 20,0	1.389 / 20,0	1.389 / 20,0	1.382 / 20,0	553 / 20,0	0,8



CUTOUT

Size [mm]	cutout [mm]	depth [mm]
□ 78	□ 68	148
□ 107	□ 96	171

Alle Lumenangaben für 4000K
 All lumen values for 4000K
 Toutes les données de lumens pour 4000K



Runder LED-Einbaudownlight direktstrahlend. Leuchte aus Aluminium-Druckguss mit einer Einbautiefe von 122, 150 bzw. 180 mm. Durch den modularen Aufbau dieser Strahler-Familie gibt es die Leuchte wahlweise mit einem Durchmesser von 84 mm (Ausschnitt 75 mm), 162 mm (Ausschnitt 150 mm) oder 216 mm (Ausschnitt 200 mm). Oberfläche der Leuchte feinstruktur matt pulverbeschichtet ähnlich RAL 9016 weiß oder ähnlich RAL 9005 schwarz. Das Baukastensystem ermöglicht das Auswählen von zwei unterschiedliche Reflektor-Farben: silber-matt oder schwarz-matt für eine reduzierte Leuchtdichte (UGR<19). Die Leuchte kann wahlweise ohne Betriebsgerät oder inkl. LED-Treiber in verschiedenen Leistungsstufen – on/off oder DALI – bestellt werden. Farbtemperaturen 3000K oder 4000K für alle Größen, dynamisch Weiß (2700K–6500K) nur für die Größen 162 und 216 mm – Farbwiedergabe CRI>90 – Mac Adam ≤3. Weitere Optionen und Konfigurationen auf Anfrage möglich.

Round recessed LED downlight with direct beam. Luminaire made of die-cast aluminium with a mounting depth of 122, 150 or 180 mm. Due to the modular design of this spotlight family, the luminaire is available either with a diameter of 84 mm (cut-out 75 mm), 162 mm (cut-out 150 mm) or 216 mm (cut-out 200 mm). Surface of the luminaire fine structure matt powder coated similar to RAL 9016 white or similar to RAL 9005 black. The modular system allows the selection of two different reflector colours: matt silver or matt black for reduced luminance (UGR<19). The luminaire can be ordered either without power supply unit or incl. LED driver in various power levels - on/off or DALI. Colour temperatures 3000K or 4000K for all sizes, dynamic white (2700K-6500K) only for sizes 162 and 216 mm - colour rendering CRI>90 - Mac Adam ≤3. Further options and configurations available on request.

Spot LED rond à encastrer à éclairage direct. Luminaire en aluminium moulé sous pression avec une profondeur d'encastrement de 148 ou 171 mm. Grâce à la structure modulaire de cette famille de projecteurs, le luminaire est disponible au choix avec un diamètre de 78 mm (découpe de 68 mm) ou de 110 mm (découpe de 100 mm). La surface du luminaire est revêtue d'une structure fine mate, similaire au RAL 9016 blanc ou au RAL 9005 noir. Le système modulaire permet de choisir entre quatre ou cinq réflecteurs différents : argent brillant, argent mat, noir mat, or mat ainsi qu'argent mat asymétrique pour la taille 110 mm. Le luminaire peut être commandé au choix sans appareillage ou avec un pilote LED - on/off ou DALI. Températures de couleur 2700K, 3000K ou 4000K - Rendu des couleurs CRI>90 - Mac Adam ≤3. Autres options et configurations possibles sur demande.

ÜBERSICHT | OVERVIEW | VUE D'ENSEMBLE

TECHNICAL DATA

3000K / 4000K / 2700-6500K

CRI>90

MacAdam ≤ 3

on-off / DALI

beam angle: 50° / 60°

L80 B10 50.000h



Contact us for more options...

HOUSING COLOUR

schwarz | black | noir
RAL 9005



weiß | white | blanc
RAL 9016



REFLECTOR COLOUR

silber matt | silver matt | argenté mat



schwarz matt | black matt | noir mat



EINBAULEUCHE „techDOT“
RECESSED LUMINAIRE “techDOT”
LUMINAIRE ENCASTRABLE « techDOT »

Bestellbeispiel | Example order | Exemple de commande
 162 mm, 60°, CRI>90, 4000K, direct, low output on/off, black, silver matt

TD15E-609401-LOBLM

1 2 3 4 5 6

1	DURCHMESSER DIAMETER DIAMÈTRE	
	84 mm (NN, OO, DD only)	75
	162 mm	15
	216 mm	20
2	ABSTRAHLWINKEL BEAM ANGLE ANGLE DE DIFFUSION	
	50° (84 mm only)	50
	60° (162 & 216 mm only)	60
3	FARBTEMPERATUR COLOUR TEMPERATURE TEMPÉRATURE DE COULEUR	
	3000K	30
	4000K	40
	2700-6500K	DW

4	LEISTUNG & STEUERUNG OUTPUT & CONTROL SORTIE & CONTRÔLE	
	excl. driver	NN
	driver on/off (84 mm only)	OO
	driver DALI (84 mm only)	DD
	low output on/off	LO
	low output DALI (DM 216 mm only)	LD
	high output on/off	HO
	high output DALI	HD
	dynamic white DALI DT8	DW

5	GEHÄUSEFARBE HOUSING COLOUR COULEUR DU BOÎTIER	
	white RAL 9016	WH
	black RAL 9005	BL
6	REFLEKTOR FARBE REFLECTOR COLOUR COULEUR DU RÉFLECTEUR	
	silver matt	M
	black matt	B

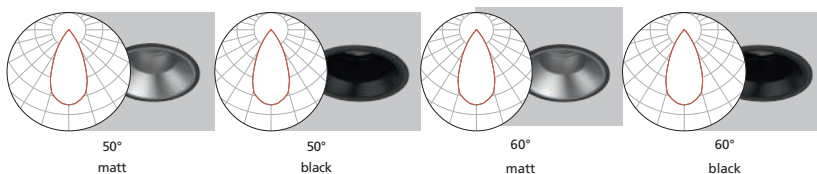
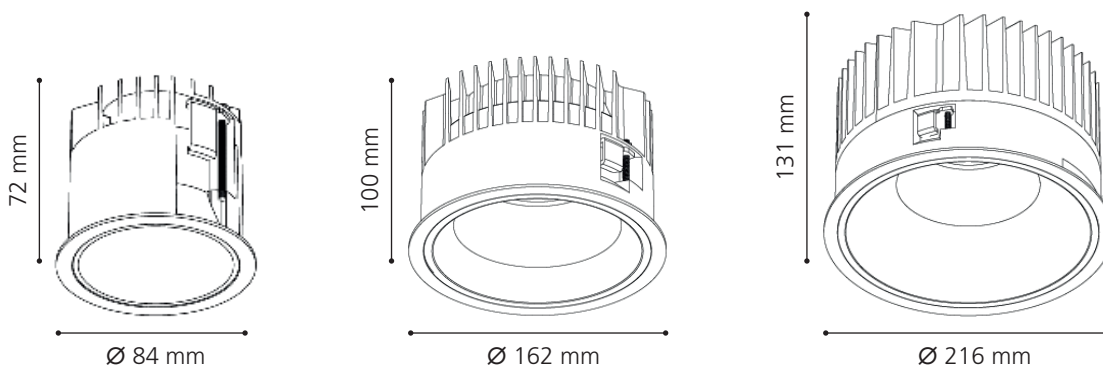

Size [mm]	output [lm] / [W]	output [lm] / [W]	low output [lm] / [W]	high output [lm] / [W]	low output [lm] / [W]	high output [lm] / [W]	KE
Ø 84	1.077 / 13,5	1.070 / 13,5	-	-	-	-	0,8
Ø 162	-	-	1.333 / 15,5	2.399 / 29,0	1.277 / 15,5	2.299 / 29,0	1,1
Ø 216	-	-	2.350 / 26	4.700 / 52,0	2.300 / 26,0	4.600 / 52,0	2,0



CUTOUT

Size [mm]	diameter [mm]	depth [mm]
Ø 84	Ø 75	122
Ø 162	Ø 150	150
Ø 216	Ø 200	180

Alle Lumenangaben für 4000K
 All lumen values for 4000K
 Toutes les données de lumens pour 4000K

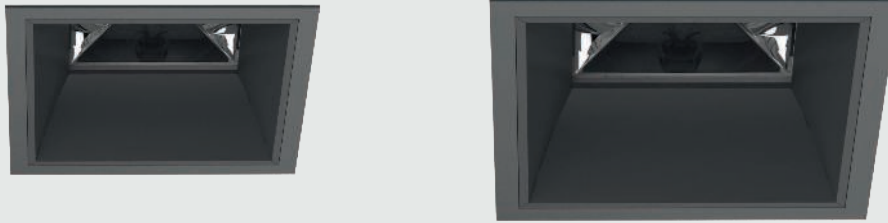

Quadratischer LED-Einbaudownlight direktstrahlend. Leuchte aus Aluminium-Druckguss mit einer Einbautiefe von 150 bzw. 180 mm. Durch den modularen Aufbau dieser Strahler-Familie gibt es die Leuchte wahlweise mit den Abmessungen 167x167 mm (Ausschnitt 150x150 mm) oder 216x216 mm (Ausschnitt 200x200 mm). Oberfläche der Leuchte feinstruktur matt pulverbeschichtet ähnlich RAL 9016 weiß oder ähnlich RAL 9005 schwarz. Das Baukastensystem ermöglicht das Auswählen von zwei unterschiedlichen Reflektor-Farben: silber-matt oder schwarz-matt für eine reduzierte Leuchtdichte (UGR<19). Die Leuchte kann wahlweise ohne Betriebsgerät oder inkl. LED-Treiber in verschiedenen Leistungsstufen – on/off oder DALI – bestellt werden. Farbtemperaturen 3000K, 4000K oder dynamisch Weiß (2700K–6500K) – Farbwiedergabe CRI>90 – Mac Adam ≤3. Weitere Optionen und Konfigurationen auf Anfrage möglich.

Square recessed LED downlight with direct beam. Luminaire made of die-cast aluminium with a mounting depth of 150 or 180 mm. Due to the modular design of this spotlight family, the luminaire is available either with the dimensions 167x167 mm (cut-out 150x150 mm) or 216x216 mm (cut-out 200x200 mm). Surface of the luminaire fine structure matt powder coated similar to RAL 9016 white or similar to RAL 9005 black. The modular system allows the selection of two different reflector colours: matt silver or matt black for reduced luminance (UGR<19). The luminaire can either be ordered without power supply unit or incl. LED driver in various power levels - on/off or DALI. Colour temperatures 3000K, 4000K or dynamic white (2700K-6500K) - colour rendering CRI>90 - Mac Adam ≤3. Further options and configurations available on request.

Spot encastré à LED carré à éclairage direct. Luminaire en aluminium moulé sous pression avec une profondeur d'encastrément de 150 ou 180 mm. Grâce à la structure modulaire de cette famille de projecteurs, le luminaire est disponible au choix avec les dimensions 167x167 mm (découpe 150x150 mm) ou 216x216 mm (découpe 200x200 mm). La surface du luminaire est revêtue d'une structure fine mate, similaire au RAL 9016 blanc ou au RAL 9005 noir. Le système modulaire permet de choisir entre deux couleurs de réflecteur différentes : argent mat ou noir mat pour un éblouissement réduit (UGR<19). Le luminaire peut être commandé au choix sans appareillage ou avec un pilote LED à différents niveaux de puissance - on/off ou DALI. Températures de couleur 3000K, 4000K ou blanc dynamique (2700K-6500K) - Rendu des couleurs CRI>90 - Mac Adam ≤3. Autres options et configurations possibles sur demande.

ÜBERSICHT | OVERVIEW | VUE D'ENSEMBLE

TECHNICAL DATA

3000K / 4000K / 2700-6500K

CRI>90

MacAdam ≤ 3

on-off / DALI

beam angle: 70°

L80 B10 50.000h



Contact us for more options...

HOUSING COLOUR

schwarz | black | noir
RAL 9005



weiß | white | blanc
RAL 9016



REFLECTOR COLOUR

silber matt | silver matt | argenté mat



schwarz matt | black matt | noir mat



EINBAULEUCHE „techSQOT“
RECESSED LUMINAIRE “techSQOT”
LUMINAIRE ENCASTRABLE « techSQOT »

Bestellbeispiel | Example order | Exemple de commande
 167 x 167 mm, 70°, CRI>90, 4000K, direct, low output on/off, black, silver matt

TS15E-709401-LOBLM

1 2 3 4 5

1 GRÖSSE SIZE TAILLE	
167 x 167 mm	15
220 x 220 mm	20

2 FARBTEMPERATUR COLOUR TEMPERATURE TEMPÉRATURE DE COULEUR	
3000K	30
4000K	40
2700-6500K	DW

3 LEISTUNG & STEUERUNG OUTPUT & CONTROL SORTIE & CONTRÔLE	
excl. driver	NN
low output on/off	LO
low output DALI (220 mm only)	LD
high output on/off	HO
high output DALI	HD
dynamic white DALI DT8	DW

4 GEHÄUSEFARBE HOUSING COLOUR COULEUR DU BOÎTIER	
white RAL 9016	WH
black RAL 9005	BL

5 REFLEKTOR FARBE REFLECTOR COLOUR COULEUR DU RÉFLECTEUR	
silver matt	M
black matt	B

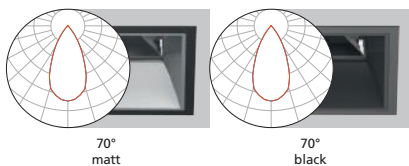
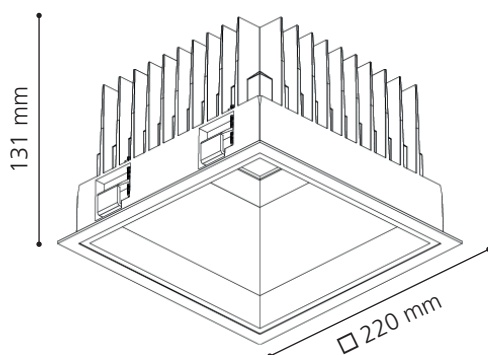
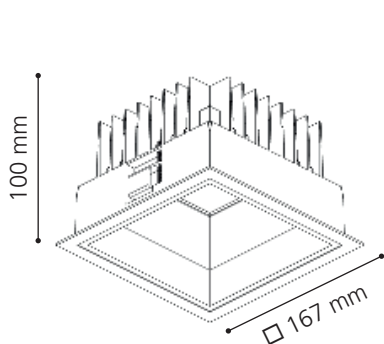

Size [mm]	70° matt		70° black		
	low output [lm] / [W]	high output [lm] / [W]	low output [lm] / [W]	high output [lm] / [W]	
□ 167	1.333 / 15,5	2.399 / 29,0	1.277 / 15,5	2.299 / 29,0	1,1
□ 220	2.350 / 26,0	4.700 / 52,0	2.300 / 26,0	4.600 / 52,0	1,8



CUTOUT

Size [mm]	cutout [mm]	depth [mm]
□ 167	150	150
□ 220	200	180

Alle Lumenangaben für 4000K
 All lumen values for 4000K
 Toutes les données de lumens pour 4000K

OVERVIEW

STEH- UND TISCHKLEMMLEUCHTEN | FREE-STANDING AND DESK-MOUNTED LUMINAIRE | *LAMPADAIRE, MONTAGE SUR TABLE*



officeLINE50free

222



officeLINE50free

224

STEH- UND TISCHKLEMMLEUCHTEN

FREE-STANDING AND DESK-MOUNTED LUMINAIRES

LUMINAIRES SUR PIED ET SUR TABLE

officeLINE50free

STEHLEUCHE | FREE-STAND | LAMPADAIRE

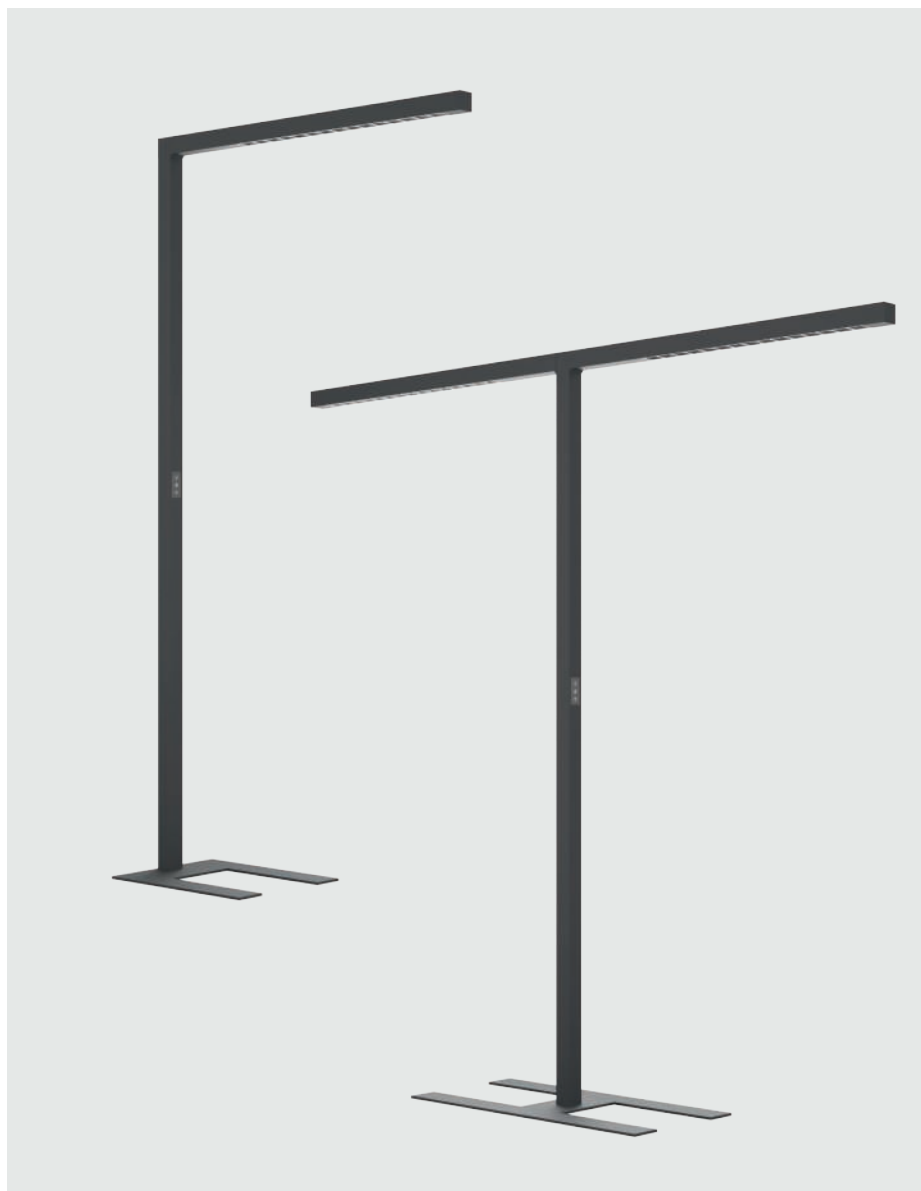

LED-Stehleuchte direkt/indirektstrahlend für Büroanwendungen. Lichtkanal aus Aluminium-Strangpressprofil mit einer Breite von 50mm. Oberfläche der Leuchte feinstrukturiert matt pulverbeschichtet ähnlich RAL 9016 weiß, RAL 9006 silber oder RAL 9005 schwarz – auf Anfrage in RAL nach Wahl. Die Stehleuchte ist ausgestattet mit einem hochwertigen, facettierten BAP-Raster mit einer Auswahl an sieben verschiedenen Farben – Oberfläche hochglänzend bzw. matt. Die Steuerung der Leuchte erfolgt über ein Touchpanel – wahlweise direkt/indirekt getrennt schalt- und dimmbar oder mit Multisensor (Bewegungs- und Tageslichtsensor). Farbtemperaturen 2700K, 3000K, 4000K oder dynamisch Weiß (2700K-6500K) – Farbwiedergabe CRI>80 oder CRI>90 – Mac Adam ≤3. Wählbar zwischen einer Single Head Variante für Doppelarbeitsplätze oder einer Double Head Variante für Vierfcharbeitsplätze. 3000mm Anschlusskabel wahlweise mit länderspezifischem Stecker Schuko CEE 7/7 (Type E+F), CH T12 (Type J) oder UK BS 1363 (Type G).

Free-standing LED luminaire with direct/indirect beam for office applications. Light channel made of extruded aluminium profile with a width of 50 mm. Surface of the luminaire fine structured matt powder coated finish similar to RAL 9016 white, RAL 9006 silver or RAL 9005 black – on request in RAL of choice. The luminaire is equipped with a high-quality, faceted BAP louvre with a choice of seven different colours – specular or matt finish. The luminaire is controlled via a touchpanel - optionally with direct/indirect separate switching and dimming or with multi-sensor (motion and daylight sensor). Colour temperatures 2700K, 3000K, 4000K or dynamic white (2700K-6500K) – colour rendering CRI>80 or CRI>90 - Mac Adam ≤3. Selectable between a single head version for double workstations or a double head version for quadruple workstations. 3000mm connection cable selectable with country-specific plug Schuko CEE 7/7 (type E+F), CH T12 (type J) or UK BS 1363 (type G).

Lampadaire LED à éclairage direct/indirect pour les applications bureautiques. Canal lumineux en profile d'aluminium extrudé d'une largeur de 50 mm. Surface du luminaire à structure fine, revêtement par poudre mat similaire à RAL 9016 blanc, RAL 9006 argent ou RAL 9005 noir – sur demande en RAL au choix. Le luminaire est équipé d'une grille BAP à facettes de haute qualité avec un choix de sept couleurs différentes – surface brillante ou mate. Le luminaire est commandé par un écran tactile - au choix avec commutation et gradation séparées directes/indirectes ou avec multi-capteur (détecteur de mouvement et de lumière du jour). Températures de couleur 2700K, 3000K, 4000K ou blanc dynamique (2700K-6500K) – Rendu des couleurs CRI>80 ou CRI>90 - Mac Adam ≤3. Choix entre une version à une tête pour les postes de travail doubles ou une version à deux têtes pour les postes de travail quadruples. Câble de raccordement de 3 000 mm pouvant être équipé d'une fiche Schuko CEE 7/7 (type E+F), CH T12 (type J) ou UK BS 1363 (type G) spécifique à chaque pays.

ÜBERSICHT | OVERVIEW | VUE D'ENSEMBLE

TECHNICAL DATA

2700K / 3000K / 4000K / 2700-6500K

CRI>80 / CRI>90

MacAdam ≤ 3

up to 141 lm/W

dimmable / dimmable + multisensor

direct/indirect

BAP Louvre (UGR <19)

L80 B10 50.000h



RAL colour of your choice



Contact us for more options...

HOUSING COLOUR

schwarz | black | noir
RAL 9005



silber | silver | argent
RAL 9006



weiß | white | blanc
RAL 9016



BAP LOUVRE COLOUR

silber hochglanz | silver specular | argenté brillant



gold hochglanz | gold specular | doré brillant



silber matt | silver matt | argenté mat



bronze hochglanz | bronze specular | bronze brillant



schwarz hochglanz | black specular | noir brillant



titan hochglanz | titan specular | titan brillant



schwarz matt | black matt | noir mat



STEHLEUCHTE „officeLINE50free“

FREE-STAND “officeLINE50free”

LAMPADAIRE « officeLINE50free »

Bestellbeispiel | Example order | Exemple de commande

Free-Stand Single head, 1055 mm, CRI90, 4000K, **direct + indirect**, high output dimmable with Multisensor, Schuko CEE 7/7 (Type E+F), black, gold specular

OL50S-1E9402-HSBLG

1 2 3 4 5 6 7

1 KONFIGURATION CONFIGURATION CONFIGURATION

Single head	1
Double head	2

2 STECKER PLUG PRISE

Schuko CEE 7/7 (Type E+F)	E
CH T12 (Type J)	C
UK BS 1363 (Type G)	U

3 FARBWIEDERGABE COLOUR RENDERING RENDU DES COULEURS

CRI>80	8
CRI>90	9

4 FARBTEMPERATUR COLOUR TEMPERATURE TEMPÉRATURE DE COULEUR

2700K (CRI>90 only)	27
3000K	30
4000K	40
2700-6500K (CRI>90 only)	DW

5 LEISTUNG & STEUERUNG OUTPUT & CONTROL SORTIE & CONTRÔLE

low output - dimmable	LD
low output - dimmable multisensor	LS
high output - dimmable	HD
high output - dimmable multisensor	HS
dynamic white - dimmable multisensor	DW

6 GEHÄUSEFARBE HOUSING COLOUR COULEUR DU BOÎTIER

silver RAL 9006	SI
white RAL 9016	WH
black RAL 9005	BL

7 BAP-RASTER FARBE BAP LOUVRE COLOUR GRILLE BAP COULEUR

silver specular	S
silver matt	M
black specular	N
black matt	B
gold specular	G
bronze specular	C
titan specular	T

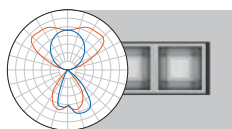
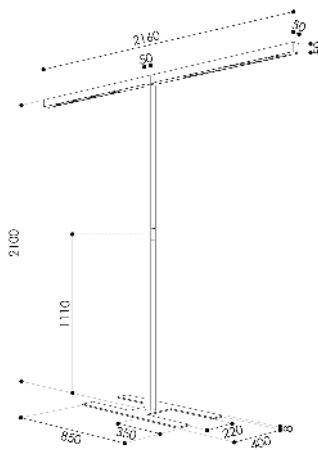
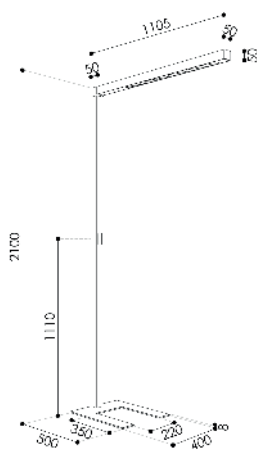

direct + indirect

Configuration	low output [lm] / [W]	high output [lm] / [W]	 [kg]
Single head	8.653 / 62,2	12.002 / 89,0	17,7
Double head	17.306 / 122,4	24.004 / 176,0	22,3

Alle Lumenangaben für 4000K, CRI>80, Reflektor silber hochglanz
All lumen values for 4000K, CRI>80, reflector silver specular
Toutes les données de lumens pour 4000K, CRI>80, réflecteur argenté brillant

officeLINE50free

TISCHKLEMMLEUCHE | DESK-MOUNTED LUMINAIRE | LUMINAIRE MONTAGE SUR TABLE



LED-Tischleuchte direkt/indirekt strahlend für Büroanwendungen. Lichtkanal aus Aluminium-Strangpressprofil mit einer Breite von 50mm. Oberfläche der Leuchte feinstruktur matt pulverbeschichtet ähnlich RAL 9016 weiß, RAL 9006 silber oder RAL 9005 schwarz – auf Anfrage in RAL nach Wahl. Die Tischleuchte ist ausgestattet mit einem hochwertigen, facettierten BAP-Raster mit einer Auswahl an sieben verschiedenen Farben – Oberfläche hochglänzend bzw. matt. Die Steuerung der Leuchte erfolgt über ein Touchpanel – wahlweise direkt/indirekt getrennt schalt- und dimmbar oder mit Multisensor (Bewegungs- und Tageslichtsensor). Farbtemperaturen 2700K, 3000K, 4000K oder dynamisch Weiß (2700K-6500K) – Farbwiedergabe CRI>80 oder CRI>90 – Mac Adam ≤3. 3000mm Anschlusskabel wahlweise mit länderspezifischem Stecker Schuko CEE 7/7 (Type E+F), CH T12 (Type J) oder UK BS 1363 (Type G).

Desk-mounted LED luminaire with direct/indirect beam for office applications. Light channel made of extruded aluminium profile with a width of 50 mm. Surface of the luminaire fine structured matt powder coated finish similar to RAL 9016 white, RAL 9006 silver or RAL 9005 black – on request in RAL of choice. The desk-mounted luminaire is equipped with a high-quality, faceted BAP louvre with a choice of seven different colours – specular or matt finish. The luminaire is controlled via a touchpanel - optionally with direct/indirect separate switching and dimming or with multi-sensor (motion and daylight sensor). Colour temperatures 2700K, 3000K, 4000K or dynamic white (2700K-6500K) – colour rendering CRI>80 or CRI>90 - Mac Adam ≤3. 3000mm connection cable selectable with country-specific plug Schuko CEE 7/7 (type E+F), CH T12 (type J) or UK BS 1363 (type G).

Luminaire LED monté sur table à éclairage direct/indirect pour les applications bureautiques. Canal lumineux en profile d'aluminium extrudé d'une largeur de 50 mm. Surface du luminaire à structure fine, revêtement par poudre mat similaire à RAL 9016 blanc, RAL 9006 argent ou RAL 9005 noir – sur demande en RAL au choix. Le luminaire est équipé d'une grille BAP à facettes de haute qualité avec un choix de sept couleurs différentes – surface brillante ou mate. Le luminaire est commandé par un écran tactile - au choix avec commutation et gradation séparées directes/indirectes ou avec multi-capteur (détecteur de mouvement et de lumière du jour). Températures de couleur 2700K, 3000K, 4000K ou blanc dynamique (2700K-6500K) – Rendu des couleurs CRI>80 ou CRI>90 - Mac Adam ≤3. Câble de raccordement de 3 000 mm pouvant être équipé d'une fiche Schuko CEE 7/7 (type E+F), CH T12 (type J) ou UK BS 1363 (type G) spécifique à chaque pays.

ÜBERSICHT | OVERVIEW | VUE D'ENSEMBLE

TECHNICAL DATA

2700K / 3000K / 4000K / 2700-6500K

CRI>80 / CRI>90

MacAdam ≤ 3

up to 139 lm/W

dimmable / dimmable + Touchpanel

direct/indirect

BAP Louvre (UGR <19)

L80 B10 50.000h



RAL colour of your choice



Contact us for more options...

HOUSING COLOUR

schwarz | black | *noir*
RAL 9005



silber | silver | *argent*
RAL 9006



weiß | white | *blanc*
RAL 9016



BAP LOUVRE COLOUR

silber hochglanz | silver specular | *argenté brillant*



gold hochglanz | gold specular | *doré brillant*



silber matt | silver matt | *argenté mat*



bronze hochglanz | bronze specular | *bronze brillant*



schwarz hochglanz | black specular | *noir brillant*



titan hochglanz | titan specular | *titan brillant*



schwarz matt | black matt | *noir mat*



TISCHKLEMMLEUCHE „officeLINE50free“
DESK-MOUNTED LUMINAIRE “officeLINE50free”
LUMINAIRE MONTAGE SUR TABLE « officeLINE50free »

Bestellbeispiel | Example order | Exemple de commande

Desk-mounted Single head, 1055 mm, CRI90, 4000K, direct + indirect,
 high output dimmable with Multisensor, Schuko CEE 7/7 (Type E+F), black, gold specular

OL50D-1 E 9 402-HSBLG

1 2 3 4 5 6

1 STECKER
 PLUG
 PRISE

Schuko CEE 7/7 (Type E+F)	E
CH T12 (Type J)	C
UK BS 1363 (Type G)	U

2 FARBWIEDERGABE
 COLOUR RENDERING
 RENDU DES COULEURS

CRI>80	8
CRI>90	9

3 FARBTEMPERATUR
 COLOUR TEMPERATURE
 TEMPÉRATURE DE COULEUR

2700K (CRI>90 only)	27
3000K	30
4000K	40
2700-6500K (CRI>90 only)	DW

4 LEISTUNG & STEUERUNG
 OUTPUT & CONTROL
 SORTIE & CONTRÔLE

low output - dimmable	LD
low output - dimmable multisensor	LS
high output - dimmable	HD
high output - dimmable multisensor	HS
dynamic white - dimmable multisensor	DW

5 GEHÄUSEFARBE
 HOUSING COLOUR
 COULEUR DU BOÎTIER

silver RAL 9006	SI
white RAL 9016	WH
black RAL 9005	BL

6 BAP-RASTER FARBE
 BAP LOUVRE COLOUR
 GRILLE BAP COULEUR

silver specular	S
silver matt	M
black specular	N
black matt	B
gold specular	G
bronze specular	C
titan specular	T

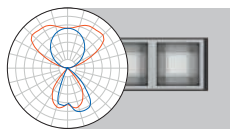
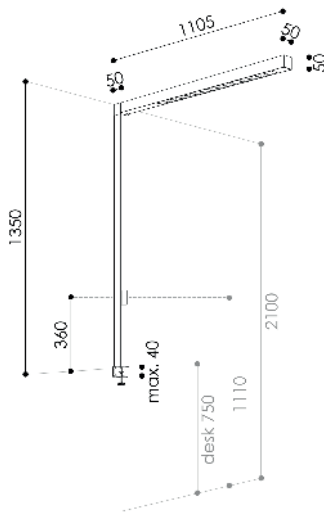

direct + indirect

Configuration	low output [lm] / [W]	high output [lm] / [W]	 kg
Single head	8.653 / 62,2	12.002 / 89,0	5,8

Alle Lumenangaben für 4000K, CRI>80, Reflektor silber hochglanz
 All lumen values for 4000K, CRI>80, reflector silver specular
 Toutes les données de lumens pour 4000K, CRI>80, réflecteur argenté brillant

OVERVIEW

SCHIENENSTRAHLER | TRACK SPOTLIGHTS | PROJECTEURS SUR RAIL



GLOWmini
228



GLOWsmall
230



GLOWmedium
232



GLOWlarge
234



GLOWultra
236



GLOWgu10
238



trackS
240



trackM
242



LINE50
244



officeLINE50
246

SCHIENENSTRAHLER

TRACK SPOTLIGHTS

PROJECTEURS SUR RAIL

GLOWmini

SCHIENENSTRAHLER | TRACK SPOTLIGHT | PROJECTEUR SUR RAIL



LED 3-Phasen-Schiene-Strahler direktstrahlend. Leuchte aus Aluminium-Druckguss mit einem Durchmesser von 54 mm und einer Höhe von 75 mm. Durch den modularen Aufbau dieser Strahler-Familie gibt es die Leuchte wahlweise mit einem Abstrahlwinkel von 30° oder 55°. Oberfläche der Leuchte feinstruktur matt pulverbeschichtet ähnlich RAL 9016 weiß oder ähnlich RAL 9005 schwarz. Die Leuchte ist ausgestattet mit einem hochwertigen Dekorring mit einer Auswahl an acht verschiedenen Farben – Oberfläche hochglänzend bzw. matt. Die Leuchte kann mit inTrack-Adapter on/off oder DALI bestellt werden. Farbtemperaturen 2700K, 3000K, 4000K Farbwiedergabe CRI>80 bzw. CRI>90 – MacAdam ≤ 2. Weitere Optionen und Konfigurationen auf Anfrage möglich.

LED 3-phase track spotlight direct beam. Luminaire made of die-cast aluminium with a diameter of 54 mm and a height of 75 mm. Due to the modular design of this spotlight family, the luminaire is either available with a beam angle of 30° or 55°. Surface of the luminaire fine structure matt powder coated similar to RAL 9016 white or similar to RAL 9005 black. The luminaire is equipped with a high-quality decoration ring with a choice of eight different colours – surface specular or matt. The luminaire can be ordered with inTrack adapter either on/off or DALI. Colour temperatures 2700K, 3000K, 4000K - colour rendering CRI>80 or CRI>90 - MacAdam ≤ 2. Other options and configurations available upon request.

Projecteur LED triphasé sur rail à éclairage direct. Luminaire en aluminium moulé sous pression d'un diamètre de 54 mm et d'une hauteur de 75 mm. Grâce à la structure modulaire de cette famille de projecteurs, le luminaire est disponible au choix avec un angle de rayonnement de 30° ou de 55°. Surface du luminaire à structure fine, revêtement par poudre mat similaire à RAL 9016 blanc ou similaire à RAL 9005 noir. Le luminaire est équipé d'un anneau décoratif de haute qualité avec un choix de huit couleurs différentes - surface brillante ou mate. Le luminaire peut être commandé au choix avec un adaptateur inTrack on/off ou DALI. Températures de couleur 2700K, 3000K, 4000K - Rendu des couleurs CRI>80 ou CRI>90 - MacAdam ≤ 2. Autres options et configurations possibles sur demande.

ÜBERSICHT | OVERVIEW | VUE D'ENSEMBLE

TECHNICAL DATA

2700K / 3000K / 4000K

CRI>80 / CRI>90

MacAdam ≤ 2

inTrack Adapter: on-off / DALI

beam angle: 30° / 55°

L80 B10 50.000h



RAL colour of your choice



Contact us for more options...

HOUSING COLOUR

schwarz | black | *noir*
RAL 9005



weiß | white | *blanc*
RAL 9016



DECORATION RING COLOUR

silber hochglanz | silver specular | *argenté brillant*



gold hochglanz | gold specular | *doré brillant*



silber matt | silver matt | *argenté mat*



bronze hochglanz | bronze specular | *bronze brillant*



schwarz hochglanz | black specular | *noir brillant*



titan hochglanz | titan specular | *titan brillant*



schwarz matt | black matt | *noir mat*



weiß matt | white matt | *blanc mat*



SCHIENENSTRAHLER „GLOWmini“
TRACK SPOTLIGHT “GLOWmini”
PROJECTEUR SUR RAIL « GLOWmini »

Bestellbeispiel | Example order | Exemple de commande
 30°, CRI90, 4000K, **direct**, inTrack Adapter on/off, black, black matt

GL05T-309401-OOBLB

1 2 3 4 5 6

1	ABSTRAHLWINKEL BEAM ANGLE ANGLE DE DIFFUSION	
	30°	30
	55°	55

2	FARBWIEDERGABE COLOUR RENDERING RENDU DES COULEURS	
	CRI>80	8
	CRI>90	9

3	FARBTEMPERATUR COLOUR TEMPERATURE TEMPÉRATURE DE COULEUR	
	2700K (CRI>90 only)	27
	3000K	30
	4000K	40

4	LEISTUNG & STEUERUNG OUTPUT & CONTROL SORTIE & CONTRÔLE	
	on/off	OO
	DALI	DD

5	GEHÄUSEFARBE HOUSING COLOUR COULEUR DU BOÎTIER	
	white RAL 9016	WH
	black RAL 9005	BL

6	DEKORRING FARBE DECORATION RING COLOUR BAGUE DÉCORATIVE COULEUR	
	silver specular	S
	silver matt	M
	black specular	N
	black matt	B
	gold specular	G
	bronze specular	C
	titan specular	T
	white matt	W

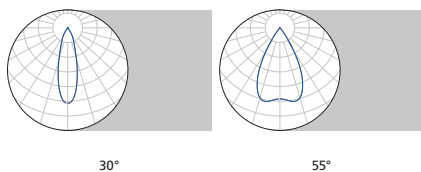
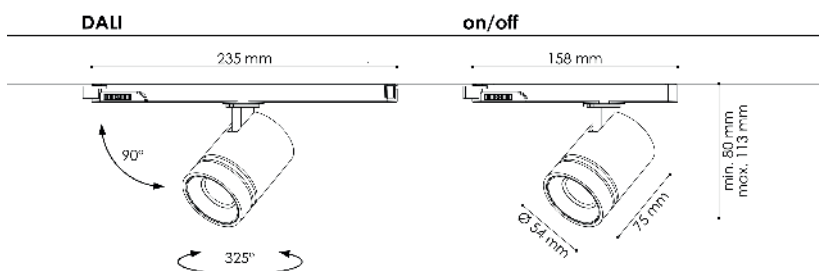

Size [mm]	output [lm] / [W]	output [lm] / [W]	[kg]
Ø 54 x 75	1.261 / 13,5	1.274 / 13,5	0,34

Alle Lumenangaben für 4000K, CRI>80
 All lumen values for 4000K, CRI>80
 Toutes les données de lumens pour 4000K, CRI>80

GLOWsmall

SCHIENENSTRAHLER | TRACK SPOTLIGHT | PROJECTEUR SUR RAIL



LED 3-Phasen-Schiene-Strahler direktstrahlend. Leuchte aus Aluminium-Druckguss mit einem Durchmesser von 66 mm und einer Höhe von 83 mm. Durch den modularen Aufbau dieser Strahler-Familie gibt es die Leuchte wahlweise mit einem Abstrahlwinkel von 30° oder 55°. Oberfläche der Leuchte feinstruktur matt pulverbeschichtet ähnlich RAL 9016 weiß oder ähnlich RAL 9005 schwarz. Die Leuchte ist ausgestattet mit einem hochwertigen Dekorring mit einer Auswahl an acht verschiedenen Farben – Oberfläche hochglänzend bzw. matt. Die Leuchte kann mit inTrack-Adapter on/off oder DALI bestellt werden. Farbtemperaturen 2700K, 3000K, 4000K Farbwiedergabe CRI>80 bzw. CRI>90 – MacAdam ≤ 2. Weitere Optionen und Konfigurationen auf Anfrage möglich.

LED 3-phase track spotlight direct beam. Luminaire made of die-cast aluminium with a diameter of 66 mm and a height of 83 mm. Due to the modular design of this spotlight family, the luminaire is either available with a beam angle of 30° or 55°. Surface of the luminaire fine structure matt powder coated similar to RAL 9016 white or similar to RAL 9005 black. The luminaire is equipped with a high-quality decoration ring with a choice of eight different colours – surface specular or matt. The luminaire can be ordered with inTrack adapter either on/off or DALI. Colour temperatures 2700K, 3000K, 4000K - colour rendering CRI>80 or CRI>90 - MacAdam ≤ 2. Other options and configurations available upon request.

Projecteur LED triphasé sur rail à éclairage direct. Luminaire en aluminium moulé sous pression d'un diamètre de 66 mm et d'une hauteur de 83 mm. Grâce à la structure modulaire de cette famille de projecteurs, le luminaire est disponible au choix avec un angle de rayonnement de 30° ou de 55°. Surface du luminaire à structure fine, revêtement par poudre mat similaire à RAL 9016 blanc ou similaire à RAL 9005 noir. Le luminaire est équipé d'un anneau décoratif de haute qualité avec un choix de huit couleurs différentes - surface brillante ou mate. Le luminaire peut être commandé au choix avec un adaptateur inTrack on/off ou DALI. Températures de couleur 2700K, 3000K, 4000K - Rendu des couleurs CRI>80 ou CRI>90 - MacAdam ≤ 2. Autres options et configurations possibles sur demande.

ÜBERSICHT | OVERVIEW | VUE D'ENSEMBLE

TECHNICAL DATA

2700K / 3000K / 4000K

CRI>80 / CRI>90

MacAdam ≤ 2

inTrack Adapter: on-off / DALI

beam angle: 30° / 55°

L80 B10 50.000h



325°

90°



RAL colour of your choice



Contact us for more options...

HOUSING COLOUR

schwarz | black | *noir*
RAL 9005



weiß | white | *blanc*
RAL 9016



DECORATION RING COLOUR

silber hochglanz | silver specular | *argenté brillant*



gold hochglanz | gold specular | *doré brillant*



silber matt | silver matt | *argenté mat*



bronze hochglanz | bronze specular | *bronze brillant*



schwarz hochglanz | black specular | *noir brillant*



titan hochglanz | titan specular | *titan brillant*



schwarz matt | black matt | *noir mat*



weiß matt | white matt | *blanc mat*



SCHIENENSTRAHLER „GLOWsmall“
TRACK SPOTLIGHT “GLOWsmall”
PROJECTEUR SUR RAIL « GLOWsmall »

Bestellbeispiel | Example order | Exemple de commande
 30°, CRI90, 4000K, **direct**, inTrack Adapter on/off, black, black matt

GL06T-309401-OOBLB

1 2 3 4 5 6

1	ABSTRAHLWINKEL BEAM ANGLE ANGLE DE DIFFUSION	
	30°	30
	55°	55

2	FARBWIEDERGABE COLOUR RENDERING RENDU DES COULEURS	
	CRI>80	8
	CRI>90	9

3	FARBTEMPERATUR COLOUR TEMPERATURE TEMPÉRATURE DE COULEUR	
	2700K (CRI>90 only)	27
	3000K	30
	4000K	40

4	LEISTUNG & STEUERUNG OUTPUT & CONTROL SORTIE & CONTRÔLE	
	on/off	OO
	DALI	DD

5	GEHÄUSEFARBE HOUSING COLOUR COULEUR DU BOÎTIER	
	white RAL 9016	WH
	black RAL 9005	BL

6	DEKORRING FARBE DECORATION RING COLOUR BAGUE DÉCORATIVE COULEUR	
	silver specular	S
	silver matt	M
	black specular	N
	black matt	B
	gold specular	G
	bronze specular	C
	titan specular	T
	white matt	W

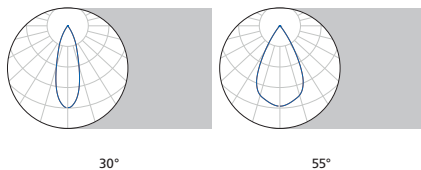
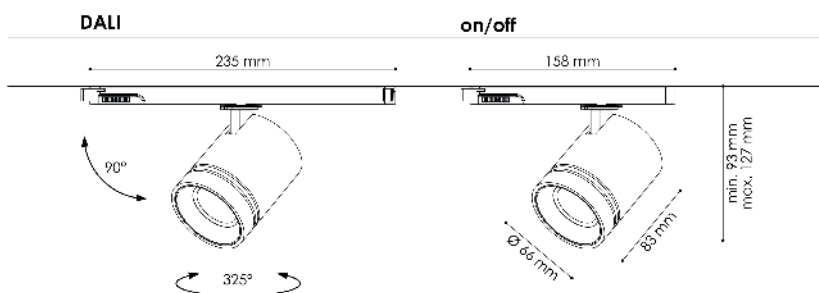

Size [mm]	output [lm] / [W]	output [lm] / [W]	[kg]
Ø 66 x 83	1.772 / 15,5	1.732 / 15,5	0,43

Alle Lumenangaben für 4000K, CRI>80
 All lumen values for 4000K, CRI>80
 Toutes les données de lumens pour 4000K, CRI>80

GLOWmedium

SCHIENENSTRAHLER | TRACK SPOTLIGHT | PROJECTEUR SUR RAIL



LED 3-Phasen-Schiene-Strahler direktstrahlend. Leuchte aus Aluminium-Druckguss mit einem Durchmesser von 90 mm und einer Höhe von 102 mm. Durch den modularen Aufbau dieser Strahler-Familie gibt es die Leuchte wahlweise mit einem Abstrahlwinkel von 15°, 24° oder 55°. Oberfläche der Leuchte feinstruktur matt pulverbeschichtet ähnlich RAL 9016 weiß oder ähnlich RAL 9005 schwarz. Die Leuchte ist ausgestattet mit einem hochwertigen Dekorring mit einer Auswahl an acht verschiedenen Farben – Oberfläche hochglänzend bzw. matt. Die Leuchte kann mit inTrack-Adapter on/off oder DALI bestellt werden. Farbtemperaturen 2700K, 3000K, 4000K sowie spezial-COB LEDs für Fashion (3500K), Backwaren, Fleisch & Wurst, Fisch oder Gemüse – Farbwiedergabe CRI>80 oder CRI>90 bzw. basierend auf der spezial COB LED – Mac Adam ≤ 2. Weitere Optionen und Konfigurationen auf Anfrage möglich.

LED 3-phase track spotlight direct beam. Luminaire made of die-cast aluminium with a diameter of 90 mm and a height of 102 mm. Due to the modular design of this spotlight family, the luminaire is either available with a beam angle of 15°, 24° or 55°. Surface of the luminaire fine structure matt powder coated similar to RAL 9016 white or similar to RAL 9005 black. The luminaire is equipped with a high-quality decoration ring with a choice of eight different colours – surface specular or matt. The luminaire can be ordered with inTrack adapter either on/off or DALI. Colour temperatures 2700K, 3000K, 4000K as well as special COB LEDs for fashion (3500K), bakery, meat & sausage, fish or vegetables – colour rendering CRI>80 or CRI>90 or based on the CRI of the special COB LED – Mac Adam ≤ 2. Other options and configurations available upon request.

Projecteur LED triphasé sur rail à éclairage direct. Luminaire en aluminium moulé sous pression d'un diamètre de 90 mm et d'une hauteur de 102 mm. Grâce à la structure modulaire de cette famille de projecteurs, le luminaire est disponible au choix avec un angle de rayonnement de 15°, 24° ou de 55°. Surface du luminaire à structure fine, revêtement par poudre mat similaire à RAL 9016 blanc ou similaire à RAL 9005 noir. Le luminaire est équipé d'un anneau décoratif de haute qualité avec un choix de huit couleurs différentes – surface brillante ou mate. Le luminaire peut être commandé au choix avec un adaptateur inTrack on/off ou DALI. Températures de couleur 2700K, 3000K, 4000K ainsi que des LED COB spéciales pour la mode (3500K), la boulangerie, la viande et la charcuterie, le poisson ou les légumes – rendu des couleurs IRC>80 ou IRC>90 ou en fonction de l'IRC de la LED COB spéciale – Mac Adam ≤ 2. Autres options et configurations possibles sur demande.

ÜBERSICHT | OVERVIEW | VUE D'ENSEMBLE

TECHNICAL DATA

2700K / 3000K / 4000K / many special COBs

CRI>80 / CRI>90 / many special COBs

MacAdam ≤ 2

inTrack Adapter: on-off / DALI

beam angle: 15° / 24° / 55°

L80 B10 50.000h



RAL colour of your choice



Contact us for more options...

HOUSING COLOUR

schwarz | black | *noir*
RAL 9005



weiß | white | *blanc*
RAL 9016



DECORATION RING COLOUR

silber hochglanz | silver specular | *argenté brillant*



gold hochglanz | gold specular | *doré brillant*



silber matt | silver matt | *argenté mat*



bronze hochglanz | bronze specular | *bronze brillant*



schwarz hochglanz | black specular | *noir brillant*



titan hochglanz | titan specular | *titan brillant*



schwarz matt | black matt | *noir mat*



weiß matt | white matt | *blanc mat*



SCHIENENSTRAHLER „GLOWmedium“
TRACK SPOTLIGHT “GLOWmedium”
PROJECTEUR SUR RAIL « GLOWmedium »

Bestellbeispiel | Example order | Exemple de commande
 15°, CRI90, 4000K, **direct**, inTrack Adapter low output on/off, black, black matt

GL09T-159401-LOBLB

1 2 3 4 5 6

1 ABSTRAHLWINKEL BEAM ANGLE ANGLE DE DIFFUSION		
15°		15
24°		24
55°		55

2 FARBWIEDERGABE COLOUR RENDERING RENDU DES COULEURS		
CRI>70 (meat only)		7
CRI>80		8
CRI>90 (fashion CRI>95)		9

3 FARBTEMPERATUR COLOUR TEMPERATURE TEMPÉRATURE DE COULEUR		
2700K (CRI>90 only)		27
3000K		30
fashion 3500K (CRI>95 only)		35
4000K		40
bakery (CRI>90 only)		BA
meat (CRI>70 only)		ME
fish (CRI>80 only)		FI
vegetables (CRI>90 only)		VE

4 LEISTUNG & STEUERUNG OUTPUT & CONTROL SORTIE & CONTRÔLE		
low output on/off		LO
low output DALI		LD
high output on/off		HO
high output DALI		HD

5 GEHÄUSEFARBE HOUSING COLOUR COULEUR DU BOÎTIER		
white RAL 9016		WH
black RAL 9005		BL

6 DEKORRING FARBE DECORATION RING COLOUR BAGUE DÉCORATIVE COULEUR		
silver specular		S
silver matt		M
black specular		N
black matt		B
gold specular		G
bronze specular		C
titan specular		T
white matt		W

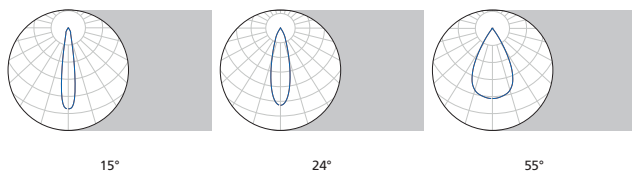
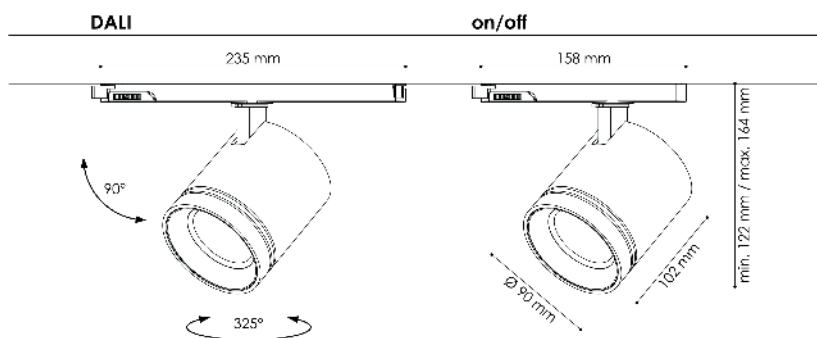

Size [mm]	low output [lm] / [W]		high output [lm] / [W]		low output [lm] / [W]	high output [lm] / [W]		KG
	low output	high output	low output	high output		low output	high output	
Ø 90 x 102	1.832 / 14,9	3.230 / 28,5	1.865 / 14,9	3.289 / 28,5	1.855 / 14,9	3.271 / 28,5	0,69	

Alle Lumenangaben für 4000K, CRI>80
 All lumen values for 4000K, CRI>80
 Toutes les données de lumens pour 4000K, CRI>80

GLOWlarge

SCHIENENSTRAHLER | TRACK SPOTLIGHT | PROJECTEUR SUR RAIL



LED 3-Phasen-Schiene-Strahler direktstrahlend. Leuchte aus Aluminium-Druckguss mit einem Durchmesser von 103 mm und einer Höhe von 109 mm. Durch den modularen Aufbau dieser Strahler-Familie gibt es die Leuchte wahlweise mit einem Abstrahlwinkel von 15°, 24° oder 55°. Oberfläche der Leuchte feinstruktur matt pulverbeschichtet ähnlich RAL 9016 weiß oder ähnlich RAL 9005 schwarz. Die Leuchte ist ausgestattet mit einem hochwertigen Dekorring mit einer Auswahl an acht verschiedenen Farben – Oberfläche hochglänzend bzw. matt. Die Leuchte kann mit inTrack-Adapter on/off oder DALI bestellt werden. Farbtemperaturen 2700K, 3000K, 4000K sowie spezial-COB LEDs für Fashion (3500K), Backwaren, Fleisch & Wurst, Fisch oder Gemüse – Farbwiedergabe CRI>80 oder CRI>90 bzw. basierend auf der spezial COB LED – Mac Adam ≤ 2. Weitere Optionen und Konfigurationen auf Anfrage möglich.

LED 3-phase track spotlight direct beam. Luminaire made of die-cast aluminium with a diameter of 103 mm and a height of 109 mm. Due to the modular design of this spotlight family, the luminaire is either available with a beam angle of 15°, 24° or 55°. Surface of the luminaire fine structure matt powder coated similar to RAL 9016 white or similar to RAL 9005 black. The luminaire is equipped with a high-quality decoration ring with a choice of eight different colours – surface specular or matt. The luminaire can be ordered with inTrack adapter either on/off or DALI. Colour temperatures 2700K, 3000K, 4000K as well as special COB LEDs for fashion (3500K), bakery, meat & sausage, fish or vegetables – colour rendering CRI>80 or CRI>90 or based on the CRI of the special COB LED – Mac Adam ≤ 2. Other options and configurations available upon request.

Projecteur LED triphasé sur rail à éclairage direct. Luminaire en aluminium moulé sous pression d'un diamètre de 103 mm et d'une hauteur de 109 mm. Grâce à la structure modulaire de cette famille de projecteurs, le luminaire est disponible au choix avec un angle de rayonnement de 15°, 24° ou de 55°. Surface du luminaire à structure fine, revêtement par poudre mat similaire à RAL 9016 blanc ou similaire à RAL 9005 noir. Le luminaire est équipé d'un anneau décoratif de haute qualité avec un choix de huit couleurs différentes – surface brillante ou mate. Le luminaire peut être commandé au choix avec un adaptateur inTrack on/off ou DALI. Températures de couleur 2700K, 3000K, 4000K ainsi que des LED COB spéciales pour la mode (3500K), la boulangerie, la viande et la charcuterie, le poisson ou les légumes – rendu des couleurs IRC>80 ou IRC>90 ou en fonction de l'IRC de la LED COB spéciale – Mac Adam ≤ 2. Autres options et configurations possibles sur demande.

ÜBERSICHT | OVERVIEW | VUE D'ENSEMBLE

TECHNICAL DATA

2700K / 3000K / 4000K / many special COBs

CRI>80 / CRI>90 / many special COBs

MacAdam ≤ 2

inTrack Adapter: on-off / DALI

beam angle: 15° / 24° / 55°

L80 B10 50.000h



RAL colour of your choice



Contact us for more options...

HOUSING COLOUR

schwarz | black | *noir*
RAL 9005



weiß | white | *blanc*
RAL 9016



DECORATION RING COLOUR

silber hochglanz | silver specular | *argenté brillant*



gold hochglanz | gold specular | *doré brillant*



silber matt | silver matt | *argenté mat*



bronze hochglanz | bronze specular | *bronze brillant*



schwarz hochglanz | black specular | *noir brillant*



titan hochglanz | titan specular | *titan brillant*



schwarz matt | black matt | *noir mat*



weiß matt | white matt | *blanc mat*



SCHIENENSTRAHLER „GLOWlarge“
TRACK SPOTLIGHT “GLOWlarge”
PROJECTEUR SUR RAIL « GLOWlarge »

Bestellbeispiel | Example order | Exemple de commande
 15°, CRI90, 4000K, **direct**, inTrack Adapter low output on/off, black, black matt

GL10T-159401-LOBLB

1 2 3 4 5 6

1	ABSTRAHLWINKEL BEAM ANGLE ANGLE DE DIFFUSION	
	15°	15
	24°	24
	55°	55

2	FARBWIEDERGABE COLOUR RENDERING RENDU DES COULEURS	
	CRI>70 (meat only)	7
	CRI>80	8
	CRI>90 (fashion CRI>95)	9

3	FARBTEMPERATUR COLOUR TEMPERATURE TEMPÉRATURE DE COULEUR	
	2700K (CRI>90 only)	27
	3000K	30
	fashion 3500K (CRI>95 only)	35
	4000K	40
	bakery (CRI>90 only)	BA
	meat (CRI>70 only)	ME
	fish (CRI>80 only)	FI
	vegetables (CRI>90 only)	VE

4	LEISTUNG & STEUERUNG OUTPUT & CONTROL SORTIE & CONTRÔLE	
	low output on/off	LO
	low output DALI	LD
	high output on/off	HO
	high output DALI	HD

5	GEHÄUSEFARBE HOUSING COLOUR COULEUR DU BOÎTIER	
	white RAL 9016	WH
	black RAL 9005	BL

6	DEKORRING FARBE DECORATION RING COLOUR BAGUE DÉCORATIVE COULEUR	
	silver specular	S
	silver matt	M
	black specular	N
	black matt	B
	gold specular	G
	bronze specular	C
	titan specular	T
	white matt	W

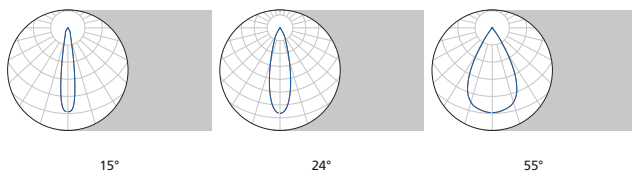
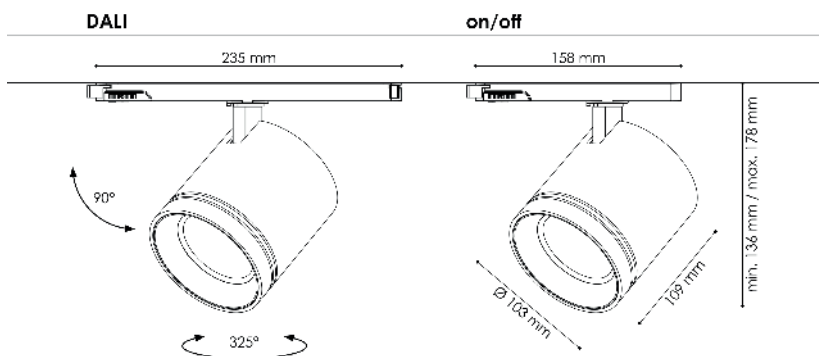

Size [mm]	low output [lm] / [W]	high output [lm] / [W]	low output [lm] / [W]	high output [lm] / [W]	low output [lm] / [W]	high output [lm] / [W]	[kg]
Ø 103 x 109	2.523 / 18,8	4.185 / 34,3	2.505 / 18,8	4.155 / 34,3	2.371 / 18,8	3.932 / 34,3	0,85

Alle Lumenangaben für 4000K, CRI>80
 All lumen values for 4000K, CRI>80
 Toutes les données de lumens pour 4000K, CRI>80

GLOWultra

SCHIENENSTRAHLER | TRACK SPOTLIGHT | PROJECTEUR SUR RAIL



LED 3-Phasen-Schiene-Strahler direktstrahlend. Leuchte aus Aluminium-Druckguss mit einem Durchmesser von 123 mm und einer Höhe von 124 mm. Durch den modularen Aufbau dieser Strahler-Familie gibt es die Leuchte wahlweise mit einem Abstrahlwinkel von 15°, 24° oder 55°. Oberfläche der Leuchte feinstruktur matt pulverbeschichtet ähnlich RAL 9016 weiß oder ähnlich RAL 9005 schwarz. Die Leuchte ist ausgestattet mit einem hochwertigen Dekorring mit einer Auswahl an acht verschiedenen Farben – Oberfläche hochglänzend bzw. matt. Die Leuchte kann mit inTrack-Adapter on/off oder DALI bestellt werden. Farbtemperaturen 2700K, 3000K, 4000K sowie spezial-COB LEDs für Fashion (3500K), Backwaren, Fleisch & Wurst, Fisch oder Gemüse – Farbwiedergabe CRI>80 oder CRI>90 bzw. basierend auf der spezial COB LED – Mac Adam ≤ 2. Weitere Optionen und Konfigurationen auf Anfrage möglich.

LED 3-phase track spotlight direct beam. Luminaire made of die-cast aluminium with a diameter of 123 mm and a height of 124 mm. Due to the modular design of this spotlight family, the luminaire is either available with a beam angle of 15°, 24° or 55°. Surface of the luminaire fine structure matt powder coated similar to RAL 9016 white or similar to RAL 9005 black. The luminaire is equipped with a high-quality decoration ring with a choice of eight different colours – surface specular or matt. The luminaire can be ordered with inTrack adapter either on/off or DALI. Colour temperatures 2700K, 3000K, 4000K as well as special COB LEDs for fashion (3500K), bakery, meat & sausage, fish or vegetables – colour rendering CRI>80 or CRI>90 or based on the CRI of the special COB LED – Mac Adam ≤ 2. Other options and configurations available upon request.

Projecteur LED triphasé sur rail à éclairage direct. Luminaire en aluminium moulé sous pression d'un diamètre de 123 mm et d'une hauteur de 124 mm. Grâce à la structure modulaire de cette famille de projecteurs, le luminaire est disponible au choix avec un angle de rayonnement de 15°, 24° ou de 55°. Surface du luminaire à structure fine, revêtement par poudre mat similaire à RAL 9016 blanc ou similaire à RAL 9005 noir. Le luminaire est équipé d'un anneau décoratif de haute qualité avec un choix de huit couleurs différentes – surface brillante ou mate. Le luminaire peut être commandé au choix avec un adaptateur inTrack on/off ou DALI. Températures de couleur 2700K, 3000K, 4000K ainsi que des LED COB spéciales pour la mode (3500K), la boulangerie, la viande et la charcuterie, le poisson ou les légumes – rendu des couleurs IRC>80 ou IRC>90 ou en fonction de l'IRC de la LED COB spéciale – Mac Adam ≤ 2. Autres options et configurations possibles sur demande.

ÜBERSICHT | OVERVIEW | VUE D'ENSEMBLE

TECHNICAL DATA

2700K / 3000K / 4000K / many special COBs

CRI>80 / CRI>90 / many special COBs

MacAdam ≤ 2

inTrack Adapter: on-off / DALI

beam angle: 15° / 24° / 55°

L80 B10 50.000h



RAL colour of your choice



Contact us for more options...

HOUSING COLOUR

schwarz | black | *noir*
RAL 9005

weiß | white | *blanc*
RAL 9016

DECORATION RING COLOUR

silber hochglanz | silver specular | *argenté brillant*

silber matt | silver matt | *argenté mat*

schwarz hochglanz | black specular | *noir brillant*

schwarz matt | black matt | *noir mat*

gold hochglanz | gold specular | *doré brillant*

bronze hochglanz | bronze specular | *bronze brillant*

titan hochglanz | titan specular | *titan brillant*

weiß matt | white matt | *blanc mat*

SCHIENENSTRAHLER „GLOWultra“
TRACK SPOTLIGHT “GLOWultra”
PROJECTEUR SUR RAIL « GLOWultra »

Bestellbeispiel | Example order | Exemple de commande
 15°, CRI90, 4000K, **direct**, inTrack Adapter low output on/off, black, black matt

GL12T-159401-LOBLB

1 2 3 4 5 6

1 ABSTRAHLWINKEL
BEAM ANGLE
ANGLE DE DIFFUSION

15°	15
24°	24
55°	55

2 FARBWIEDERGABE
COLOUR RENDERING
RENDU DES COULEURS

CRI>70 (meat only)	7
CRI>80	8
CRI>90 (fashion CRI>95)	9

3 FARBTEMPERATUR
COLOUR TEMPERATURE
TEMPÉRATURE DE COULEUR

2700K (CRI>90 only)	27
3000K	30
👗 fashion 3500K (CRI>95 only)	35
4000K	40
🍰 bakery (CRI>90 only)	BA
🥩 meat (CRI>70 only)	ME
🐟 fish (CRI>80 only)	FI
🥕 vegetables (CRI>90 only)	VE

4 LEISTUNG & STEUERUNG
OUTPUT & CONTROL
SORTIE & CONTRÔLE

low output on/off	LO
low output DALI	LD
high output on/off	HO
high output DALI	HD

5 GEHÄUSEFARBE
HOUSING COLOUR
COULEUR DU BOÎTIER

white RAL 9016	WH
black RAL 9005	BL

6 DEKORRING FARBE
DECORATION RING COLOUR
BAGUE DÉCORATIVE COULEUR

silver specular	S
silver matt	M
black specular	N
black matt	B
gold specular	G
bronze specular	C
titan specular	T
white matt	W

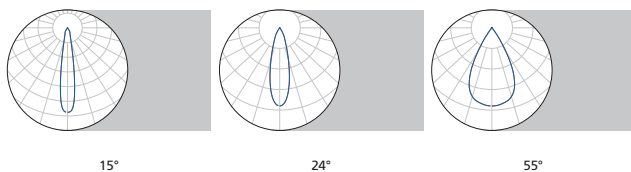
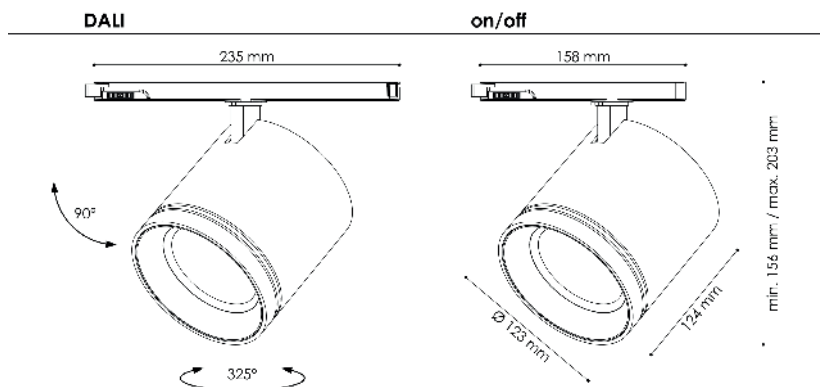

Size [mm]	low output [lm] / [W]	high output [lm] / [W]	low output [lm] / [W]	high output [lm] / [W]	low output [lm] / [W]	high output [lm] / [W]	📦 KG
Ø 123 x 124	2.814 / 20,9	4.834 / 40,4	2.761 / 20,9	4.742 / 40,4	2.806 / 20,9	4.820 / 40,4	1,19

Alle Lumenangaben für 4000K, CRI>80
 All lumen values for 4000K, CRI>80
 Toutes les données de lumens pour 4000K, CRI>80

GLOWgu10

SCHIENENSTRAHLER | TRACK SPOTLIGHT | PROJECTEUR SUR RAIL

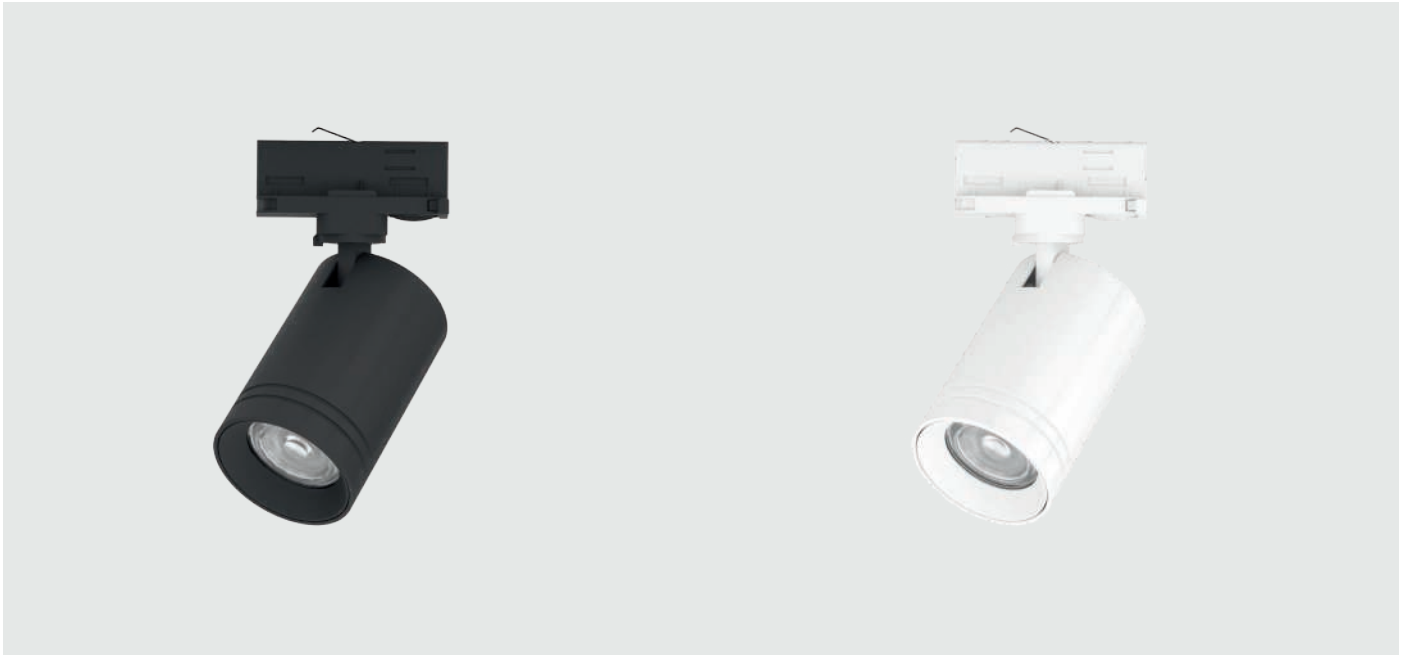

GU10 3-Phasen-Schiene-Strahler direktstrahlend inkl. GU10 Leuchtmittel. Leuchte aus Aluminium-Druckguss mit einem Durchmesser von 70 mm und einer Höhe von 110 mm. Die GU10 Variante dieser Strahler Familie ist erhältlich mit einem Abstrahlwinkel von 32°. Oberfläche der Leuchte feinstruktur matt pulverbeschichtet ähnlich RAL 9016 weiß oder ähnlich RAL 9005 schwarz. Die Leuchte ist ausgestattet mit einem hochwertigen Dekorring mit einer Auswahl an acht verschiedenen Farben – Oberfläche hochglänzend bzw. matt. Die Leuchte wird mit einem on/ off 3-Phasen-Schiene Adapter geliefert. Farbtemperaturen 2700K, 3000K, 4000K Farbwiedergabe CRI>80 Mac Adam ≤ 3. Weitere Optionen und Konfigurationen auf Anfrage möglich.

GU10 3-phase track spotlight direct beam incl. GU10 bulb. Luminaire made of die-cast aluminium with a diameter of 70 mm and a height of 110 mm. The GU10 version of this spotlight family is available with a beam angle of 32°. Surface of the luminaire fine structure matt powder coated similar to RAL 9016 white or similar to RAL 9005 black. The luminaire is equipped with a high-quality decoration ring with a choice of eight different colours – surface specular or matt. The luminaire is supplied with an on/off 3-phase track adapter. Colour temperatures 2700K, 3000K, 4000K - colour rendering CRI>80 - Mac Adam ≤ 3. Other options and configurations available upon request.

Projecteur GU10 triphasé sur rail à éclairage direct incl. Une lampe GU10. Luminaire en aluminium moulé sous pression d'un diamètre de 70 mm et d'une hauteur de 110 mm. La version GU10 de cette famille de projecteurs est disponible avec un angle de rayonnement de 32°. Surface du luminaire à structure fine, revêtement par poudre mat similaire à RAL 9016 blanc ou similaire à RAL 9005 noir. Le luminaire est équipé d'un anneau décoratif de haute qualité avec un choix de huit couleurs différentes - surface brillante ou mate. Le luminaire est fourni avec un adaptateur triphasé on/off. Températures de couleur 2700K, 3000K, 4000K - Rendu des couleurs CRI>80 - Mac Adam ≤ 3. Autres options et configurations possibles sur demande.

ÜBERSICHT | OVERVIEW | VUE D'ENSEMBLE

TECHNICAL DATA

2700K / 3000K / 4000K

CRI>80

MacAdam ≤ 3

inkl. Adapter: on-off

beam angle: 32°



RAL colour of your choice



Contact us for more options...

HOUSING COLOUR

schwarz | black | *noir*
RAL 9005



weiß | white | *blanc*
RAL 9016



DECORATION RING COLOUR

silber hochglanz | silver specular | *argenté brillant*



gold hochglanz | gold specular | *doré brillant*



silber matt | silver matt | *argenté mat*



bronze hochglanz | bronze specular | *bronze brillant*



schwarz hochglanz | black specular | *noir brillant*



titan hochglanz | titan specular | *titan brillant*



schwarz matt | black matt | *noir mat*



weiß matt | white matt | *blanc mat*



SCHIENENSTRAHLER „GLOWGU10“
 TRACK SPOTLIGHT "GLOWGU10"
 PROJECTEUR SUR RAIL « GLOWGU10 »

Bestellbeispiel | Example order | Exemple de commande
 32°, CRI>80, 3000K, direct, 3-PHS-adapter on/off, black, black matt

GL07T-108301-00BLB

1 2 3

1 FARBTEMPERATUR COLOUR TEMPERATURE TEMPÉRATURE DE COULEUR	
2700K	27
3000K	30
4000K	40

2 GEHÄUSEFARBE HOUSING COLOUR COULEUR DU BOÎTIER	
white RAL 9016	WH
black RAL 9005	BL

3 DEKORRING FARBE DECORATION RING COLOUR BAGUE DÉCORATIVE COULEUR	
silver specular	S
silver matt	M
black specular	N
black matt	B
gold specular	G
bronze specular	C
titan specular	T
white matt	W

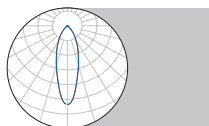
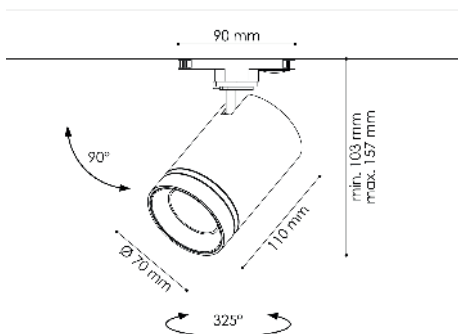

32°

Size [mm]	output [lm] / [W]	 [kg]
Ø 70 x 110	655 / 6,5	0,45

Alle Lumenangaben für 4000K, CRI>80
 All lumen values for 4000K, CRI>80
 Toutes les données de lumens pour 4000K, CRI>80



LED 3-Phasenschienen-Strahler direktstrahlend. Leuchte aus Aluminium-Druckguss mit einem Durchmesser von 55 mm und einer Höhe von 150 mm. Durch den modularen Aufbau dieser Strahler-Familie gibt es die Leuchte wahlweise mit einem Abstrahlwinkel von 18°, 36° oder 50°. Oberfläche der Leuchte feinstruktur matt pulverbeschichtet ähnlich RAL 9016 weiß oder ähnlich RAL 9005 schwarz. Dekorring des Strahlers schwarz matt. Die Leuchte kann wahlweise mit inTrack-Adapter on/off oder DALI bestellt werden. Farbtemperaturen 2700K, 3000K oder 4000K – Farbwiedergabe CRI>90 – Mac Adam ≤3. Weitere Optionen und Konfigurationen auf Anfrage möglich.

LED 3-phase track spotlight direct beam. Luminaire made of die-cast aluminium with a diameter of 55 mm and a height of 150 mm. Due to the modular design of this spotlight family, the luminaire is either available with a beam angle of 18°, 36° or 50°. Surface of the luminaire fine structure matt powder coated similar to RAL 9016 white or similar to RAL 9005 black. Decoration ring of the spotlight matt black. The luminaire can be ordered with inTrack adapter either on/off or DALI. Colour temperatures 2700K, 3000K or 4000K – colour rendering CRI>90 – Mac Adam ≤3. Further options and configurations available on request.

Projecteur LED triphasé sur rail à éclairage direct. Luminaire en aluminium moulé sous pression d'un diamètre de 55 mm et d'une hauteur de 150 mm. Grâce à la structure modulaire de cette famille de projecteurs, le luminaire est disponible au choix avec un angle de rayonnement de 18°, 36° ou 50°. Surface du luminaire à structure fine, revêtement par poudre mat similaire à RAL 9016 blanc ou similaire à RAL 9005 noir. Anneau décoratif du projecteur noir mat. Le luminaire peut être commandé au choix avec un adaptateur inTrack on/off ou DALI. Températures de couleur 2700K, 3000K ou 4000K - Rendu des couleurs CRI>90 - Mac Adam ≤3. Autres options et configurations possibles sur demande.

ÜBERSICHT | OVERVIEW | VUE D'ENSEMBLE

TECHNICAL DATA

2700K / 3000K / 4000K

CRI>90

MacAdam ≤ 3

inTrack adapter: on-off / DALI

beam angle: 18° / 36° / 50°

L80 B10 50.000h



Contact us for more options...

HOUSING COLOUR

schwarz | black | noir
RAL 9005



weiß | white | blanc
RAL 9016



DECORATION RING

schwarz matt | black matt | noir mat



SCHIENENSTRAHLER „trackS“
 TRACK SPOTLIGHT “trackS”
 PROJECTEUR SUR RAIL « trackS »

Bestellbeispiel | Example order | Exemple de commande
 36°, CRI>90, 4000K, direct, inTrack adapter on/off, black, black

TS55T-369401-OOBLB

1 2 3 4

1 ABSTRAHLWINKEL BEAM ANGLE ANGLE DE DIFFUSION	
18°	18
36°	36
50°	50

2 FARBTEMPERATUR COLOUR TEMPERATURE TEMPÉRATURE DE COULEUR	
2700K	27
3000K	30
4000K	40

3 LEISTUNG & STEUERUNG OUTPUT & CONTROL SORTIE & CONTRÔLE	
on/off	OO
DALI (Stucchi, ONEtrack/Global)	DD

4 GEHÄUSEFARBE HOUSING COLOUR COULEUR DU BOÎTIER	
white RAL 9016	WH
black RAL 9005	BL

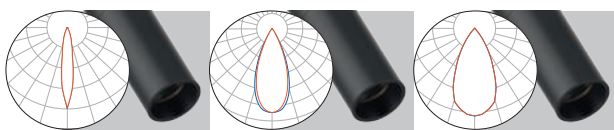
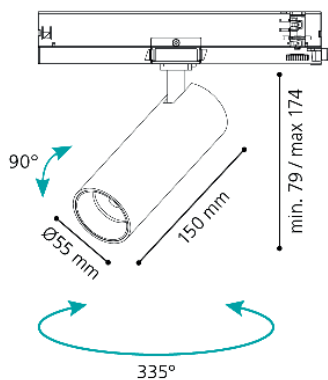

Size [mm]	output [lm] / [W]	output [lm] / [W]	output [lm] / [W]	KG
trackS	1.202 / 15,4	1.293 / 15,4	1.309 / 15,4	1,1

Alle Lumenangaben für 4000K
 All lumen values for 4000K
 Toutes les données de lumens pour 4000K



LED 3-Phasen-Schiene-Strahler direktstrahlend. Leuchte aus Aluminium-Druckguss mit einem Durchmesser von 72 mm und einer Höhe von 150 mm. Durch den modularen Aufbau dieser Strahler-Familie gibt es die Leuchte wahlweise mit einem Abstrahlwinkel von 20° oder 55°. Oberfläche der Leuchte feinstruktur matt pulverbeschichtet ähnlich RAL 9016 weiß oder ähnlich RAL 9005 schwarz. Dekorring des Strahlers schwarz matt. Die Leuchte kann wahlweise mit inTrack-Adapter on/off oder DALI bestellt werden. Farbtemperaturen 2700K, 3000K, 4000K sowie spezial-COB LEDs für Fashion (3250K), Backwaren, Fleisch, Wurst, Fisch oder Gemüse – Farbwiedergabe CRI>90 bzw. CRI>95 für Fashion – Mac Adam ≤3. Weitere Optionen und Konfigurationen auf Anfrage möglich.

LED 3-phase track spotlight direct beam. Luminaire made of die-cast aluminium with a diameter of 72 mm and a height of 150 mm. Due to the modular design of this spotlight family, the luminaire is either available with a beam angle of 20° or 55°. Surface of the luminaire fine structure matt powder coated similar to RAL 9016 white or similar to RAL 9005 black. Decoration ring of the spotlight black matt. The luminaire can be ordered with inTrack adapter either on/off or DALI. Colour temperatures 2700K, 3000K, 4000K as well as special COB LEDs for fashion (3250K), bakery, meat, sausage, fish or vegetables - colour rendering CRI>90 or CRI>95 for fashion - Mac Adam ≤3. Other options and configurations available upon request.

Projecteur LED triphasé sur rail à éclairage direct. Luminaire en aluminium moulé sous pression d'un diamètre de 72 mm et d'une hauteur de 150 mm. Grâce à la structure modulaire de cette famille de projecteurs, le luminaire est disponible au choix avec un angle de rayonnement de 20° ou de 55°. Surface du luminaire à structure fine, revêtement par poudre mat similaire à RAL 9016 blanc ou similaire à RAL 9005 noir. Anneau décoratif du projecteur noir mat. Le luminaire peut être commandé au choix avec un adaptateur inTrack on/off ou DALI. Températures de couleur 2700K, 3000K, 4000K ainsi que LED COB spéciales pour la mode (3250K) et l'alimentaire - Rendu des couleurs CRI>90 ou CRI>95 pour la mode - Mac Adam ≤3. Autres options et configurations possibles sur demande

ÜBERSICHT | OVERVIEW | VUE D'ENSEMBLE

TECHNICAL DATA

2700K / 3000K / 4000K / many special COBs

CRI>90 / CRI>95 (fashion)

MacAdam ≤ 3

inTrack adapter: on-off / DALI

beam angle: 20° / 55°

L80 B10 50.000h



Contact us for more options...

HOUSING COLOUR

schwarz | black | noir
RAL 9005



weiß | white | blanc
RAL 9016



DECORATION RING

schwarz matt | black matt | noir mat



SCHIENENSTRAHLER „trackM“
TRACK SPOTLIGHT “trackM”
PROJECTEUR SUR RAIL « trackM »

Bestellbeispiel | Example order | Exemple de commande
 20°, CRI>90, 4000K, direct, inTrack adapter on/off, black, black

TM72T-209401-OOBLB

1 2 3 4

1 ABSTRAHLWINKEL BEAM ANGLE ANGLE DE DIFFUSION	
20°	20
55°	55

2 FARBTemperatur COLOUR TEMPERATURE TEMPÉRATURE DE COULEUR	
2700K	27
3000K	30
fashion 3500K (CRI>95)	35
4000K	40
bakery	BA
meat	ME
sausage	SA
fish	FI
vegetables	VE

3 LEISTUNG & STEUERUNG OUTPUT & CONTROL SORTIE & CONTRÔLE	
on/off	OO
DALI (Stucchi, ONEtrack/Global)	DD

4 GEHÄUSEFARBE HOUSING COLOUR COULEUR DU BOÎTIER	
white RAL 9016	WH
black RAL 9005	BL

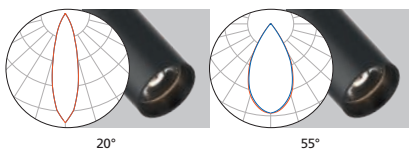
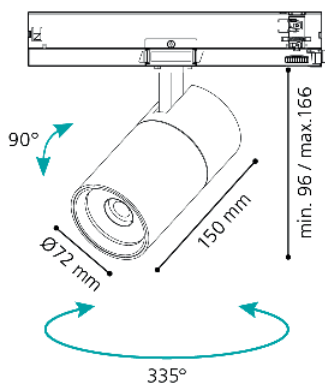

Size [mm]	output [lm] / [W]	output [lm] / [W]	[kg]
trackM	2.100 / 26,6	2.050 / 26,6	1,5

Alle Lumenangaben für 4000K
 All lumen values for 4000K
 Toutes les données de lumens pour 4000K

LINE50

SCHIENENSTRAHLER | TRACK SPOTLIGHT | PROJECTEUR SUR RAIL

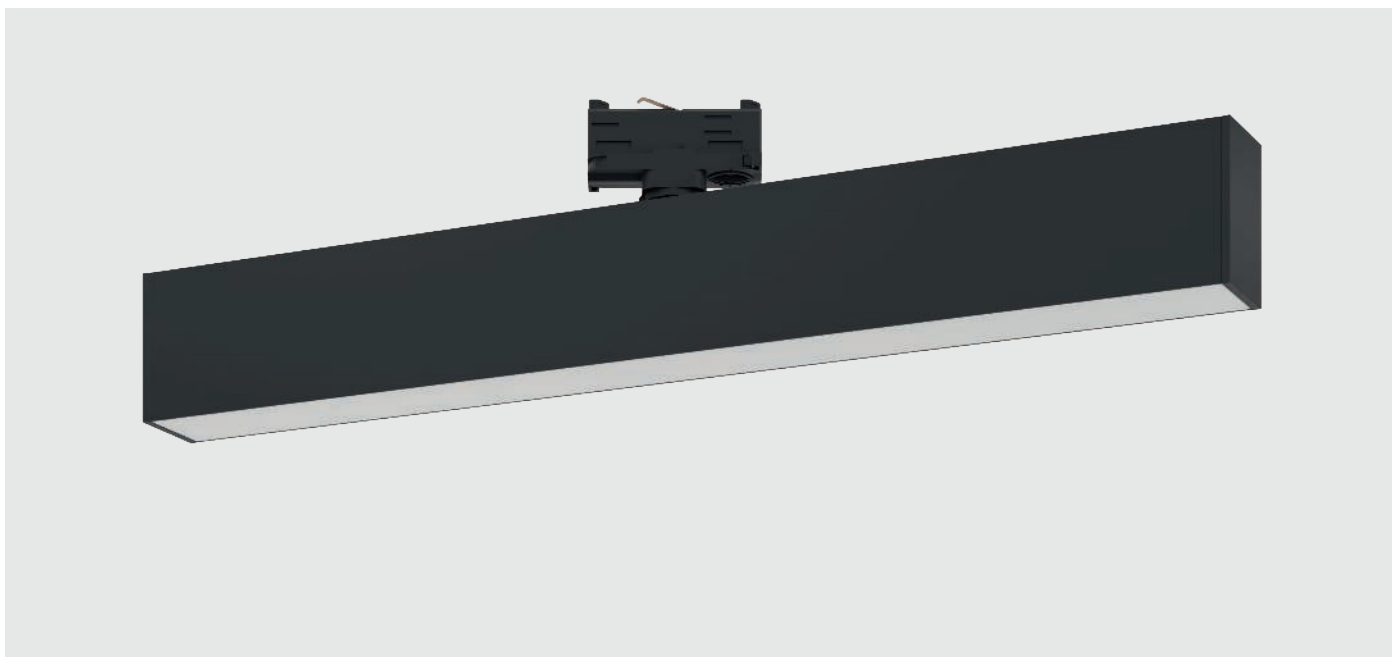

LED 3-Phasen Schienenleuchte direktstrahlend. Lichtkanal aus Aluminium-Strangpressprofil mit einer Breite von 50 mm. Fertigung der Leuchtenlänge millimetergenau auf Kundenwunsch möglich. Oberfläche der Leuchte feinstruktur matt pulverbeschichtet ähnlich RAL 9016 weiß, RAL 9006 silber oder RAL 9005 schwarz – auf Anfrage in RAL nach Wahl. Diffusor wahlweise in PMMA opal oder PMMA klar mit eingeschobener mikroprismatischer Platte für eine reduzierte Leuchtdichte (UGR<19). Der LED-Treiber ist im Leuchtgehäuse integriert – wahlweise als on/off oder DALI-Variante. Farbtemperaturen 2700K, 3000K oder 4000K – Farbwiedergabe CRI>80 oder CRI>90 – Mac Adam ≤3. Weitere Steuerungsoptionen oder Lichtfarben auf Anfrage erhältlich. Außerdem ist die Integration vieler Komponenten, wie beispielsweise Notlicht oder Sensortechnologie, sowie eine Vielzahl weiterer Optionen möglich.

LED 3-phase track luminaire with direct beam. Light channel made of extruded aluminium profile with a width of 50 mm. Luminaire length can be manufactured to the exact millimetre on customer request. Surface of the luminaire fine structure matt powder coated similar to RAL 9016 white, RAL 9006 silver or RAL 9005 black - on request in RAL of choice. Diffuser either in PMMA opal or PMMA clear with inserted microprismatic plate for reduced luminance (UGR<19). The LED driver is integrated in the luminaire housing - either as on/off or DALI version. Colour temperatures 2700K, 3000K or 4000K - colour rendering CRI>80 or CRI>90 - Mac Adam ≤3. Further control options or light colours available on request. In addition, the integration of many components, such as emergency lighting or sensor technology, as well as a variety of other options is possible.

Luminaire LED triphasé sur rail à éclairage direct. Canal lumineux en profilé d'aluminium extrudé d'une largeur de 50 mm. Fabrication de la longueur du luminaire au millimètre près possible sur demande du client. Surface du luminaire à structure fine, revêtement par poudre mat similaire à RAL 9016 blanc, RAL 9006 argent ou RAL 9005 noir - sur demande en RAL au choix. Diffuseur au choix en PMMA opale ou PMMA transparent avec plaque microprismatique insérée pour un éblouissement réduit (UGR<19). Le pilote LED est intégré dans le boîtier du luminaire - au choix sous forme de variante on/off ou DALI. Températures de couleur 2700K, 3000K ou 4000K - Rendu des couleurs CRI>80 ou CRI>90 - Mac Adam ≤3. Autres options de commande ou couleurs de lumière disponibles sur demande. En outre, l'intégration de nombreux composants, tels que l'éclairage de secours ou la technologie de détection, une multitude d'autres options sont possibles.

ÜBERSICHT | OVERVIEW | VUE D'ENSEMBLE

TECHNICAL DATA

2700K / 3000K / 4000K

CRI>80 / CRI>90

MacAdam ≤ 3

up to 122 lm/W, up to 2.766lm/m

on-off / DALI

direct

opal / microprism (UGR <19)

L80 B10 50.000h

HOUSING COLOUR

schwarz | black | noir
RAL 9005

silber | silver | argent
RAL 9006

weiß | white | blanc
RAL 9016



LED



3
SDCM

IP
20

CE

UK
CA



RAL colour of
your choice



Integration of
Multisensor



Integration of
emergency light



Contact us for
more options...

SCHIENENSTRAHLER „LINE50“
TRACK SPOTLIGHT „LINE50“
PROJECTEUR SUR RAIL « LINE50 »

Bestellbeispiel | Example order | Exemple de commande
 974 mm, CRI90, 4000K, **direct**, low output on/off, black, microprism

LI50T-099401-LOBLM

1 2 3 4 5 6

1 LÄNGE
 LENGTH
 LONGEUR

614 mm	06
974 mm	09
1.214 mm	12
1.454 mm	14

2 FARBWIEDERGABE
 COLOUR RENDERING
 RENDU DES COULEURS

CRI>80	8
CRI>90	9

3 FARBTEMPERATUR
 COLOUR TEMPERATURE
 TEMPÉRATURE DE COULEUR

2700K (CRI90 only)	27
3000K	30
4000K	40

4 LEISTUNG & STEUERUNG
 OUTPUT & CONTROL
 SORTIE & CONTRÔLE

low output on/off	LO
low output DALI	LD
high output on/off	HO
high output DALI	HD

5 GEHÄUSEFARBE
 HOUSING COLOUR
 COULEUR DU BOÎTIER

silver RAL 9006	SI
white RAL 9016	WH
black RAL 9005	BL

6 ABDECKUNG
 COVER
 COUVERTURE

opal	O
microprism	M

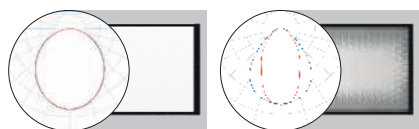
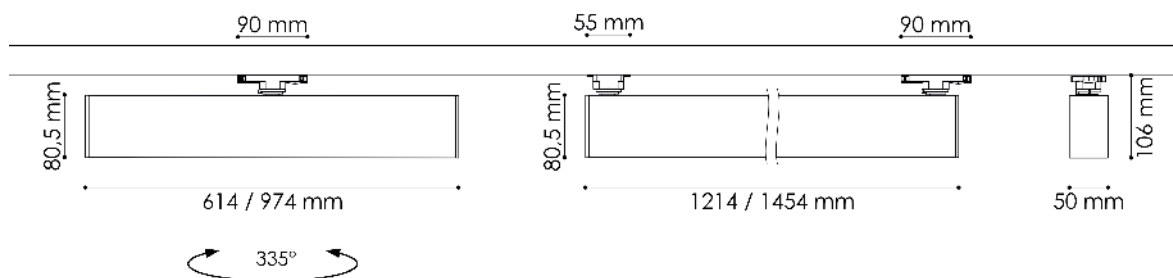

opal direct microprism direct direct

Size [mm]	low output [lm] / [W]	high output [lm] / [W]	low output [lm] / [W]	high output [lm] / [W]	
614	909 / 8,8	1.731 / 16,3	826 / 8,8	1.581 / 16,3	1,5
974	1.455 / 13,0	2.770 / 25,0	1.321 / 13,0	2.530 / 25,0	2,3
1.214	1.817 / 16,3	3.463 / 30,0	1.652 / 16,3	3.162 / 30,0	2,9
1.454	2.182 / 18,5	4.156 / 35,8	1.982 / 18,5	3.794 / 35,8	3,5

Alle Lumenangaben für 4000K, CRI>80, Microprisma ohne Opalfolie
 All lumen values for 4000K, CRI>80, microprism without opal foil
 Toutes les données de lumens pour 4000K, CRI>80, microprisme sans feuille opal

officeLINE50

SCHIENENSTRAHLER | TRACK SPOTLIGHT | PROJECTEUR SUR RAIL

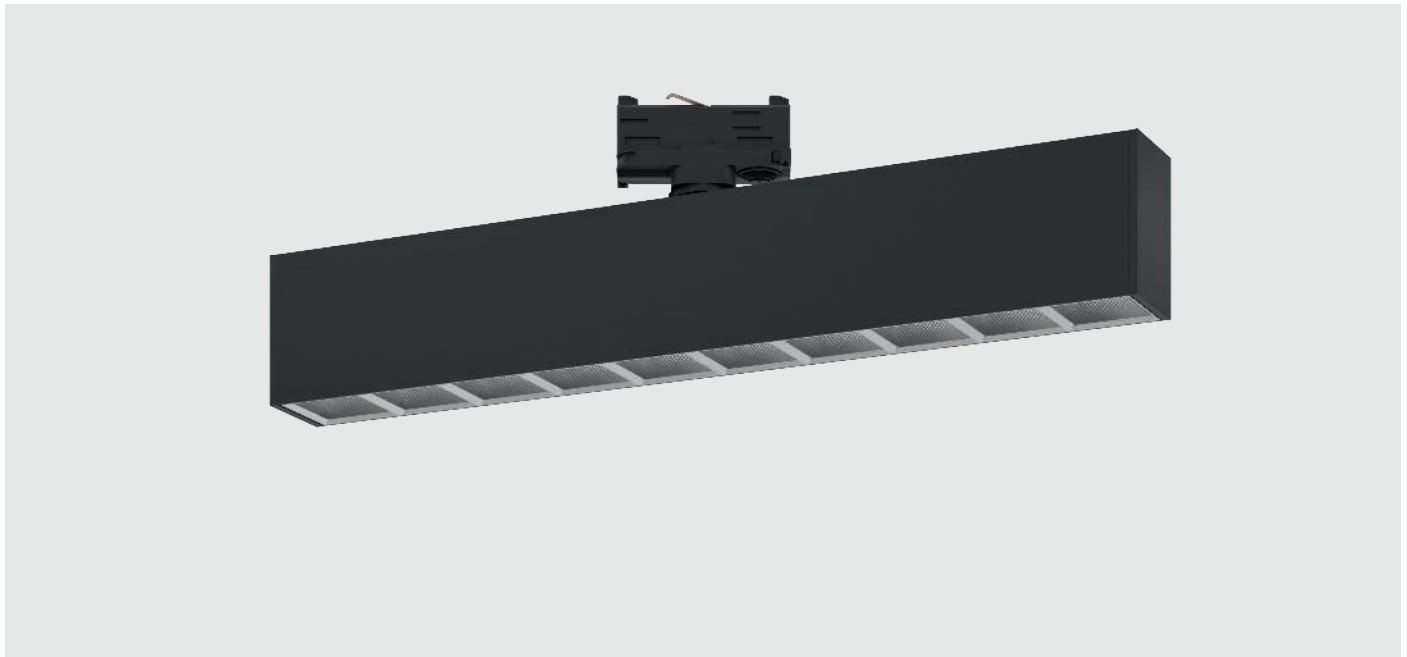

LED 3-Phasen Schienenleuchte direktstrahlend. Lichtkanal aus Aluminium-Strangpressprofil mit einer Breite von 50 mm. Fertigung der Leuchtenlänge millimetergenau auf Kundenwunsch möglich. Oberfläche der Leuchte feinstruktur matt pulverbeschichtet ähnlich RAL 9016 weiß, RAL 9006 silber oder RAL 9005 schwarz – auf Anfrage in RAL nach Wahl. Die Leuchte ist ausgestattet mit einem hochwertigen, facettierten BAP-Raster mit einer Auswahl an sieben verschiedenen Farben – Oberfläche hochglänzend bzw. matt. Der LED-Treiber ist im Leuchtgehäuse integriert – wahlweise als on/off oder DALI-Variante. Farbtemperaturen 2700K, 3000K oder 4000K – Farbwiedergabe CRI>80 oder CRI>90 – Mac Adam ≤3. Weitere Steuerungsoptionen oder Lichtfarben auf Anfrage erhältlich. Außerdem ist die Integration vieler Komponenten, wie beispielsweise Notlicht oder Sensortechnologie, sowie eine Vielzahl weiterer Optionen möglich.

LED 3-phase track luminaire with direct beam. Light channel made of extruded aluminium profile with a width of 50 mm. Luminaire length can be manufactured to the exact millimetre on customer request. Surface of the luminaire fine structure matt powder coated similar to RAL 9016 white, RAL 9006 silver or RAL 9005 black - on request in RAL of choice. The luminaire is equipped with a high-quality, faceted BAP louvre with a choice of seven different colours - specular or matt finish. The LED driver is integrated in the luminaire housing - either as on/off or DALI version. Colour temperatures 2700K, 3000K or 4000K - colour rendering CRI>80 or CRI>90 - Mac Adam ≤3. Further control options or light colours available on request. In addition, the integration of many components, such as emergency lighting or sensor technology, as well as a variety of other options is possible.

Luminaire LED triphasé sur rail à éclairage direct. Canal lumineux en profilé d'aluminium extrudé d'une largeur de 50 mm. Possibilité de fabriquer la longueur du luminaire au millimètre près sur demande du client. Surface du luminaire à structure fine, revêtement par poudre mat similaire à RAL 9016 blanc, RAL 9006 argent ou RAL 9005 noir - sur demande en RAL au choix. Le luminaire est équipé d'une grille BAP à facettes de haute qualité avec un choix de sept couleurs différentes - surface brillante ou mate. Le pilote LED est intégré dans le boîtier du luminaire - au choix sous forme de variante on/off ou DALI. Températures de couleur 2700K, 3000K ou 4000K - Rendu des couleurs CRI>80 ou CRI>90 - Mac Adam ≤3. Autres options de commande ou couleurs de lumière disponibles sur demande. En outre, l'intégration de nombreux composants, tels que l'éclairage de secours ou la technologie de détection, une multitude d'autres options sont possibles.

ÜBERSICHT | OVERVIEW | VUE D'ENSEMBLE

TECHNICAL DATA	
2700K / 3000K / 4000K	
CRI>80 / CRI>90	
MacAdam ≤ 3	
up to 147 lm/W, up to 4.422 lm/m	
on-off / DALI	
direct	
BAP-Louvre (UGR <19)	
L80 B10 50.000h	

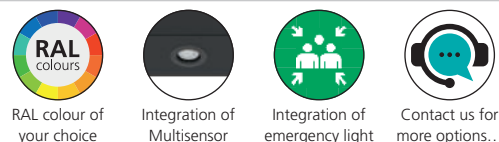
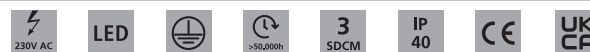

HOUSING COLOUR	
schwarz black noir RAL 9005	
silber silver argent RAL 9006	
weiß white blanc RAL 9016	

BAP LOUVRE COLOUR		
silber hochglanz silver specular argenté brillant		gold hochglanz gold specular doré brillant
silber matt silver matt argenté mat		bronze hochglanz bronze specular bronze brillant
schwarz hochglanz black specular noir brillant		titan hochglanz titan specular titan brillant
schwarz matt black matt noir mat		

SCHIENENSTRAHLER „officeLINE50“
TRACK SPOTLIGHT “officeLINE50”
PROJECTEUR SUR RAIL « officeLINE50 »

Bestellbeispiel | Example order | Exemple de commande
 971 mm, CRI90, 4000K, **direct**, low output on/off, black, gold specular

OL50T-099401-LOBLG

1 2 3 4 5 6

1 LÄNGE
 LENGTH
 LONGEUR

491 mm	06
971 mm	09
1.211 mm	12
1.451 mm	14

2 FARBWIEDERGABE
 COLOUR RENDERING
 RENDU DES COULEURS

CRI>80	8
CRI>90	9

3 FARBTEMPERATUR
 COLOUR TEMPERATURE
 TEMPÉRATURE DE COULEUR

2700K (CRI90 only)	27
3000K	30
4000K	40

4 LEISTUNG & STEUERUNG
 OUTPUT & CONTROL
 SORTIE & CONTRÔLE

low output on/off	LO
low output DALI	LD
high output on/off	HO
high output DALI	HD

5 GEHÄUSEFARBE
 HOUSING COLOUR
 COULEUR DU BOÎTIER

silver RAL 9006	SI
white RAL 9016	WH
black RAL 9005	BL

6 BAP-RASTER FARBE
 BAP LOUVRE COLOUR
 GRILLE BAP COULEUR

silver specular	S
silver matt	M
black specular	N
black matt	B
gold specular	G
bronze matt	C
titan specular	T

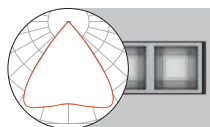
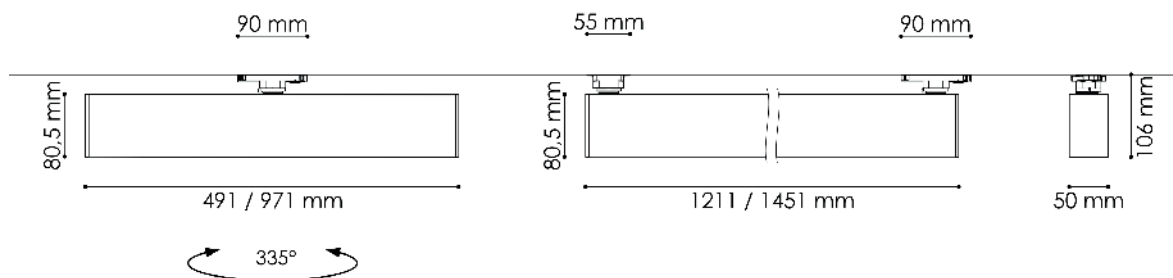

direct direct

Size [mm]	low output [lm] / [W]	high output [lm] / [W]	KE
491	1.106 / 8,6	2.064 / 16,5	1,4
971	2.212 / 16,7	4.128 / 31,9	2,3
1.211	2.765 / 20,0	5.160 / 39,0	2,8
1.451	3.318 / 23,5	6.192 / 46,0	3,3

Alle Lumenangaben für 4000K, CRI>80, Reflektor silber hochglanz
 All lumen values for 4000K, CRI>80, reflector silver specular
 Toutes les données de lumens pour 4000K, CRI>80, réflecteur argenté brillant

OVERVIEW

SCHIENEN | TRACKS | RAILS

ANBAU | SURFACE MOUNTED | *EN SAILLIE*



SLIM TRACK
252

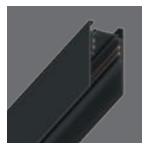

BASIC TRACK
256



ACCESSORIES
272

PENDEL | SUSPENDED | *SUSPENSION*



SLIM TRACK
252



BASIC TRACK
256



H-TRACK
260



ACCESSORIES
272

EINBAU | RECESSED | *ENCASTRÉ*

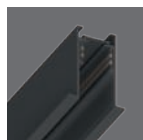

FRAME TRACK
264



FRAMELESS TRACK
268



ACCESSORIES
272

SCHIENEN & ZUBEHÖR

TRACKS & ACCESSORIES

RAILS & ACCESSOIRES

SCHIENEN

TRACKS

RAILS

1. H-TRACK PENDEL | SUSPENDED | *SUSPENSION*
2. BASIC TRACK PENDEL | SUSPENDED | *SUSPENSION*
3. SLIM TRACK PENDEL | SUSPENDED | *SUSPENSION*
4. SLIM TRACK ANBAU | SURFACE MOUNTED | *EN SAILLIE*
5. BASIC TRACK ANBAU | SURFACE MOUNTED | *EN SAILLIE*
6. FRAME TRACK EINBAU | RECESSED | *ENCASTRÉ*
7. FRAMELESS TRACK EINBAU | RECESSED | *ENCASTRÉ*

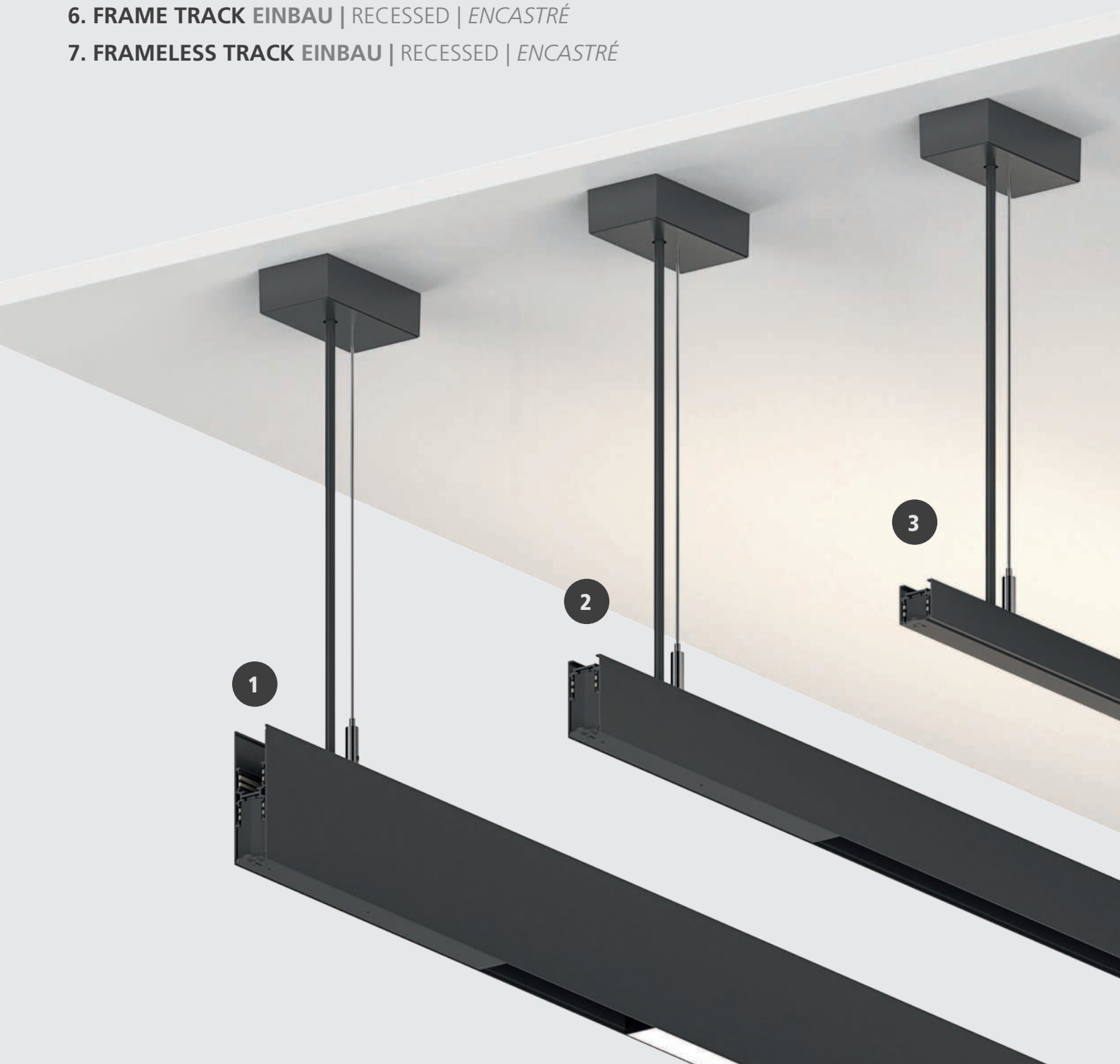



4

5

6

7

LINE48V

SLIM TRACK | SLIM TRACK | SLIM TRACK

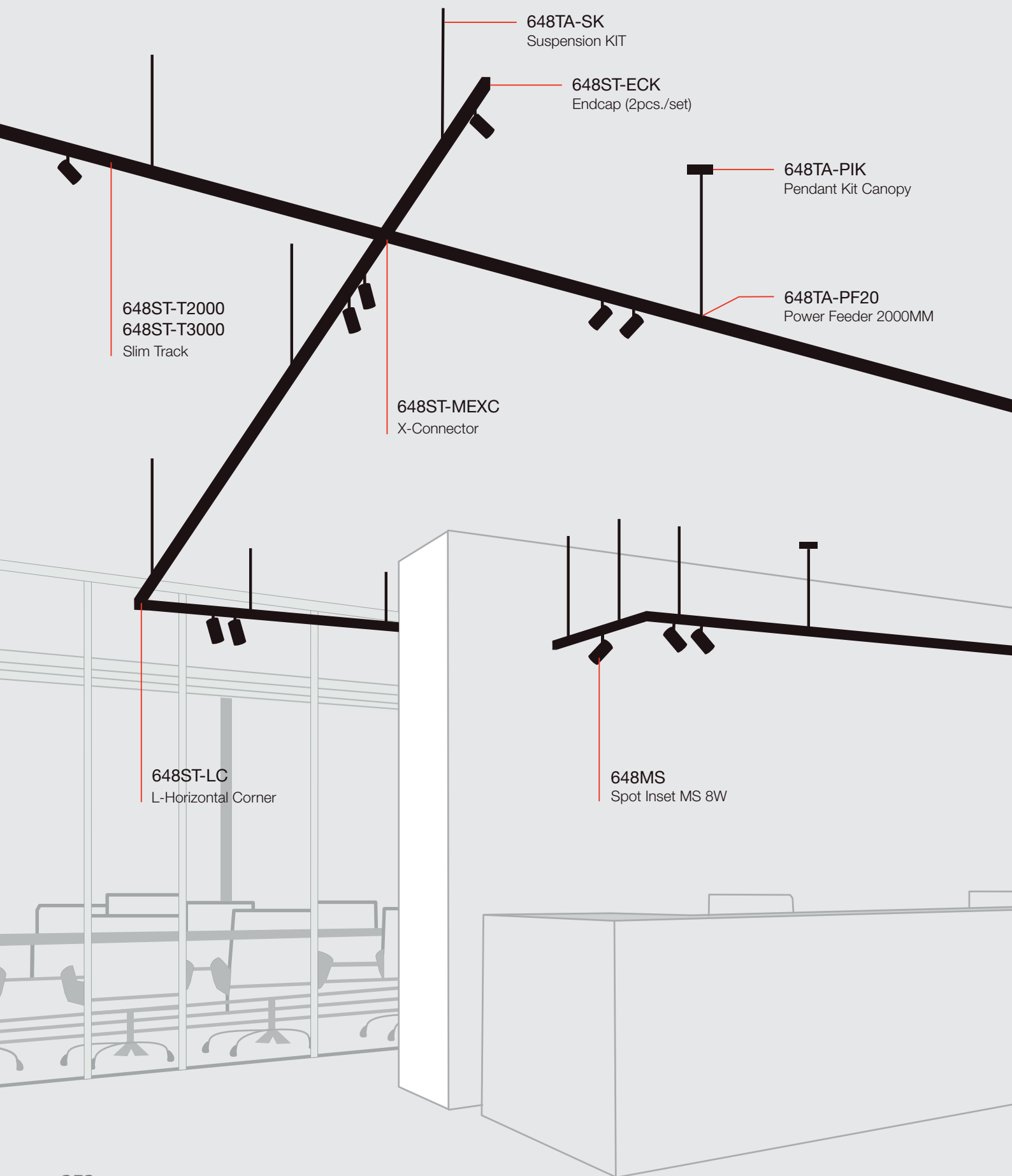

648TA-SK
Suspension KIT

648ST-ECK
Endcap (2pcs./set)

648TA-PIK
Pendant Kit Canopy

648TA-PF20
Power Feeder 2000MM

648ST-T2000
648ST-T3000
Slim Track

648ST-MEXC
X-Connector

648ST-LC
L-Horizontal Corner

648MS
Spot Inset MS 8W

648TA-SECK
Straight Electrical Connector

The diagram illustrates a lighting system with two main tracks. The upper track is a thick black line sloping downwards from left to right. It features several vertical black lines representing electrical connections. Two spotlights are mounted on this track. The lower track is a thick black line sloping upwards from left to right, meeting the upper track at a T-junction. This junction is labeled as a T-Connector. To the left, a rectangular area is highlighted, containing a track with two spotlights. This area is labeled as a Spot Inset MD 16W. A red line connects the label '648MD' to the inset track, and another red line connects the label '648ST-METC' to the T-junction. The background is a light gray with faint lines suggesting a ceiling or wall structure.

648MD
Spot Inset MD 16W

648ST-METC
T-Connector

LINE48V

SLIM TRACK | SLIM TRACK | SLIM TRACK



LINE48V ist die modulare 48V-Niedervolt-Systemlösung mit einem schlanken Designansatz, der auf ein 26 mm breites Aluminium-Strangpressprofil reduziert ist. Dank der minimalen Höhe von 27 mm bietet die SLIM TRACK ein minimalistisches, elegantes Design, das sich perfekt in die gegebene Architektur einfügt. Alle LINE48V-Schienen sind in den Farben schwarz (RAL 9005) und weiß (RAL 9016) pulverbeschichtet erhältlich. Die Leuchteinsätze werden durch einen einfachen Einrastmechanismus mit dem Profil verbunden, der ein hohes Maß an Flexibilität ohne den Einsatz von Werkzeug bietet. Um das LINE48V-System optimal zu erweitern, bieten verschiedene Verbinder in I-, L-, T- oder X-Form eine Vielzahl von Gestaltungsmöglichkeiten.

LINE48V is the modular 48V Low Voltage System solution with a sleek design approach, which is reduced to a 26 mm wide extruded aluminium profile. Thanks to the minimal height of 27 mm, the SLIM TRACK offers a sleek, elegant design, that fits perfectly into the given architecture. All LINE48V tracks are available in a powder-coated black (RAL 9005) and white (RAL 9016) finish. The light inserts will be connected to the profile by a simple click-in mechanism, which offers a high degree of flexibility without using any tools. To extend the LINE48V system to its maximum, different connectors in I, L, T or X-shape are providing a numerous design options.

LINE48V est la solution modulaire de système basse tension 48V au design épuré, qui se réduit à un profilé d'aluminium extrudé de 26 mm de large. Grâce à sa hauteur réduite de 27 mm, le SLIM TRACK offre un design minimaliste et élégant qui s'intègre parfaitement à l'architecture. Tous les rails LINE48V sont disponibles en noir (RAL 9005) et blanc (RAL 9016) avec revêtement par poudre. Les inserts lumineux seront connectés au profilé par un simple mécanisme d'encliquetage, qui offre un haut degré de flexibilité sans l'utilisation d'outils. Pour étendre le système LINE48V au maximum, différents connecteurs en forme de I, L, T ou X offrent de nombreuses options de conception.

ÜBERSICHT | OVERVIEW | VUE D'ENSEMBLE



SURFACE MOUNTED

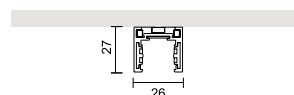

SUSPENDED

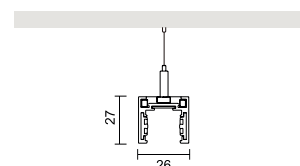

colour	housing material	dimensions [mm]	weight [kg]	material number
■ black [RAL 9005]	aluminium	L 2000 / W 26 / H 27	1,44	648ST-T2000-B
□ white [RAL 9016]	aluminium	L 2000 / W 26 / H 27	1,44	648ST-T2000-W
■ black [RAL 9005]	aluminium	L 3000 / W 26 / H 27	2,16	648ST-T3000-B
□ white [RAL 9016]	aluminium	L 3000 / W 26 / H 27	2,16	648ST-T3000-W

ACCESSORIES BLACK

648ST-ECK-B	
648ST-LC-B	
648ST-LVC-B	
648ST-METC-B	
648ST-MEXC-B	

ACCESSORIES WHITE

648ST-ECK-W	
648ST-LC-W	
648ST-LVC-W	
648ST-METC-W	
648ST-MEXC-W	

- All article numbers of the accessories can be found on p. 272 and 273.
- Corners incl. flexible continuous electrical kit.

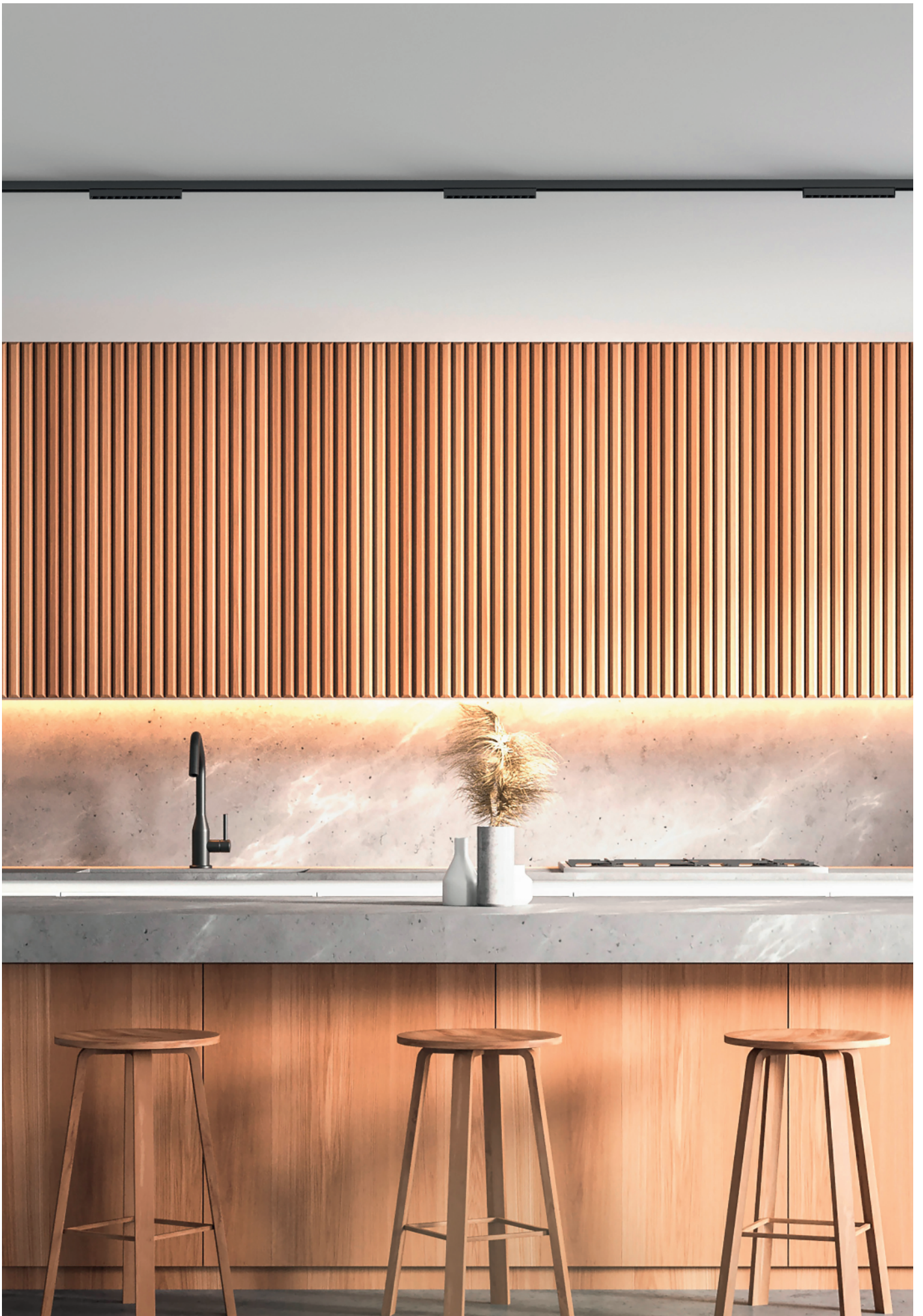

LINE48V

BASIC TRACK | BASIC TRACK | BASIC TRACK

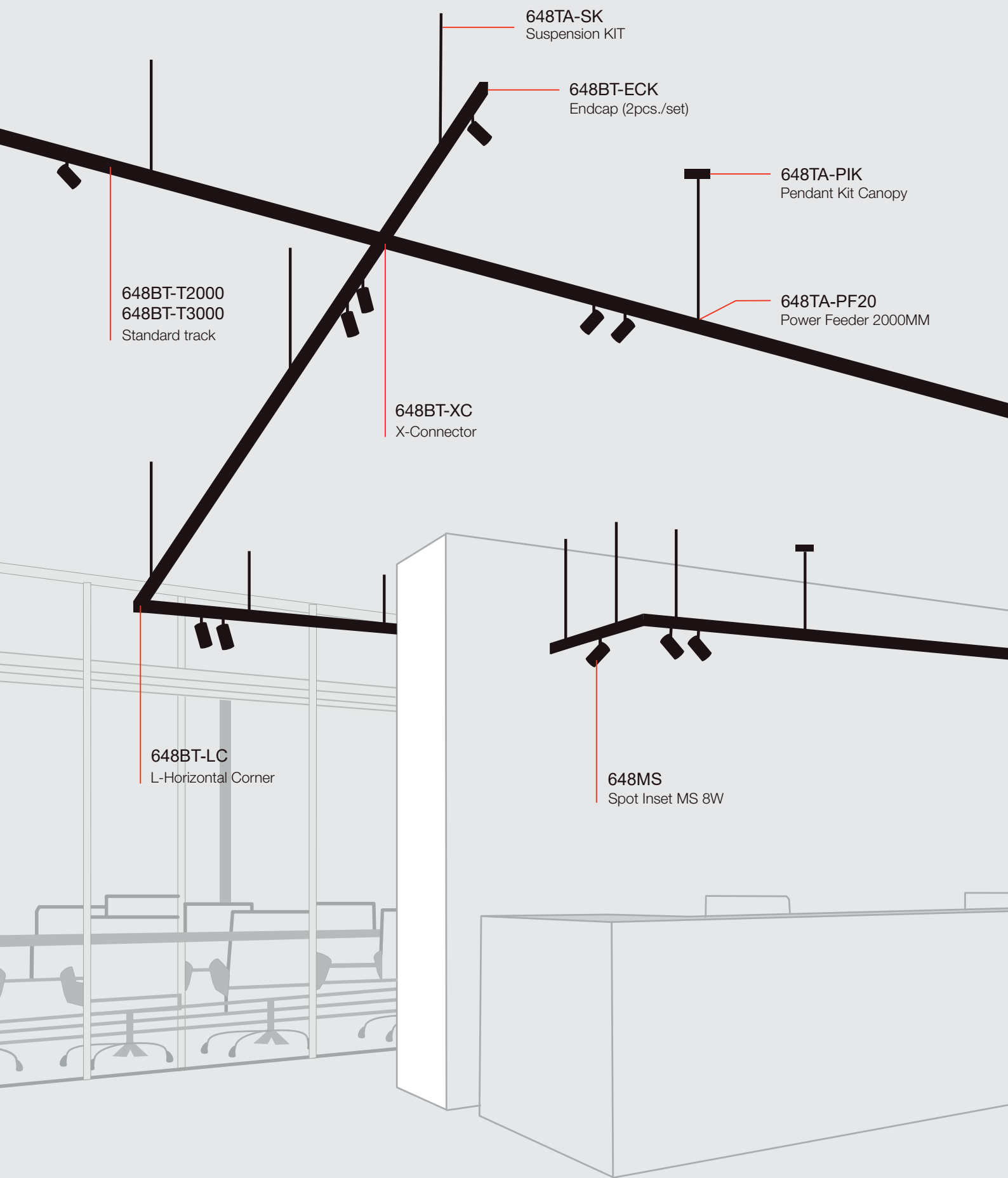

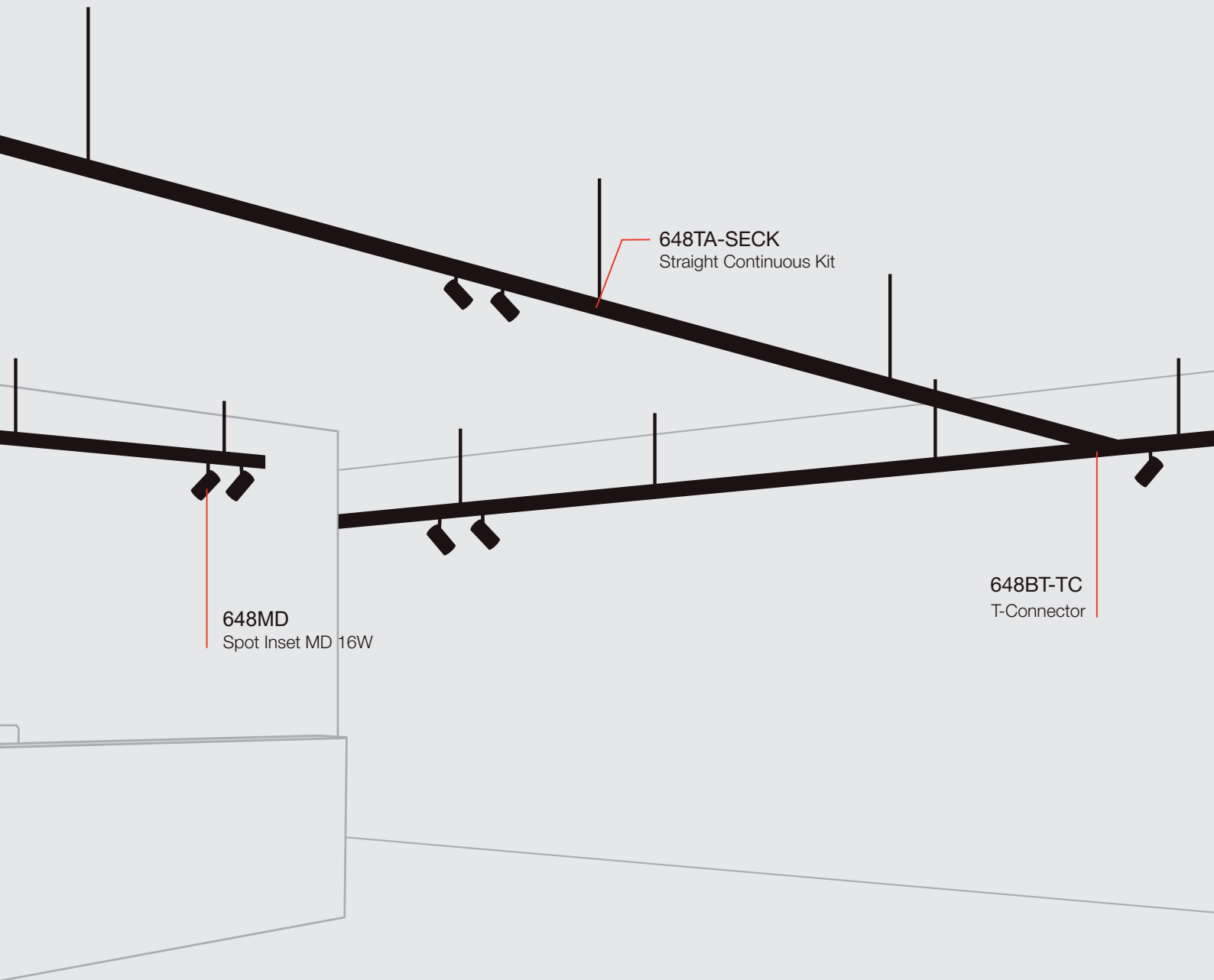

648TA-SECK
Straight Continuous Kit

648MD
Spot Inset MD 16W

648BT-TC
T-Connector

LINE48V

BASIC TRACK | BASIC TRACK | BASIC TRACK



LINE48V ist die modulare 48V-Niedervolt-Systemlösung mit einem schlanken Designansatz, der auf ein 26 mm breites Aluminium-Strangpressprofil reduziert ist. Die BASIC TRACK mit einer Höhe von 52 mm ermöglicht ideale Lösungen für die Hänge und Anbaumontage. Alle LINE48V-Stromschienen sind in den Farben schwarz (RAL 9005) und weiß (RAL 9016) pulverbeschichtet erhältlich. Die Lichteinsätze werden durch einen einfachen Einrastmechanismus mit dem Profil verbunden, der ein hohes Maß an Flexibilität ohne den Einsatz von Werkzeug bietet. Um das LINE48V-System optimal zu erweitern, bieten verschiedene Verbinder in I-, L-, T- oder X-Form eine Vielzahl von Gestaltungsmöglichkeiten.

LINE48V is the modular 48V Low Voltage System solution with a sleek design approach, which is reduced to a 26 mm wide extruded aluminium profile. The BASIC TRACK with the height of 52 mm allows ideal solutions for pendant and surface mounted installation. All LINE48V tracks are available in a powder-coated black (RAL 9005) and white (RAL 9016) finish. The light inserts will be connected to the profile by a simple click-in mechanism, which offers a high degree of flexibility without using any tools. To extend the LINE48V system to its maximum, different connectors in I, L, T or X-shape are providing a numerous design options.

LINE48V est la solution modulaire de système basse tension de 48V avec une approche de conception élégante, réduite à un profilé d'aluminium extrudé de 26 mm de large. Le rail BASIC, d'une hauteur de 52 mm, offre des solutions idéales pour les installations suspendues ou en saillie. Tous les rails LINE48V sont disponibles en noir (RAL 9005) et blanc (RAL 9016) avec revêtement par poudre. Les modules d'éclairage seront connectés au profilé par un simple mécanisme d'encliquetage, ce qui offre un haut degré de flexibilité sans utiliser d'outils. Pour étendre au maximum le système LINE48V, différents connecteurs en I, L, T ou X offrent de nombreuses possibilités de conception.

ÜBERSICHT | OVERVIEW | VUE D'ENSEMBLE



SURFACE MOUNTED

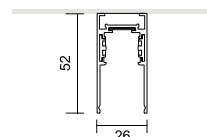

SUSPENDED

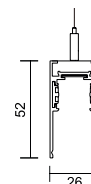

colour	housing material	dimensions [mm]	weight [kg]	material number
■ black [RAL 9005]	aluminium	L 2000 / W 26 / H 52	2,10	648BT-T2000-B
□ white [RAL 9016]	aluminium	L 2000 / W 26 / H 52	2,10	648BT-T2000-W
■ black [RAL 9005]	aluminium	L 3000 / W 26 / H 52	3,15	648BT-T3000-B
□ white [RAL 9016]	aluminium	L 3000 / W 26 / H 52	3,15	648BT-T3000-W

ACCESSORIES BLACK

648BT-ECK-B



648BT-LC-B



648BT-LVC-B



648BT-TC-B



648BT-XC-B



648TA-SK-B



ACCESSORIES WHITE

648BT-ECK-W



648BT-LC-W



648BT-LVC-W



648BT-TC-W



648BT-XC-W



- All article numbers of the accessories can be found on p. 272 and 273.
- Corners incl. flexible continuous electrical kit.



LINE48V

H-TRACK | H-TRACK | H-TRACK

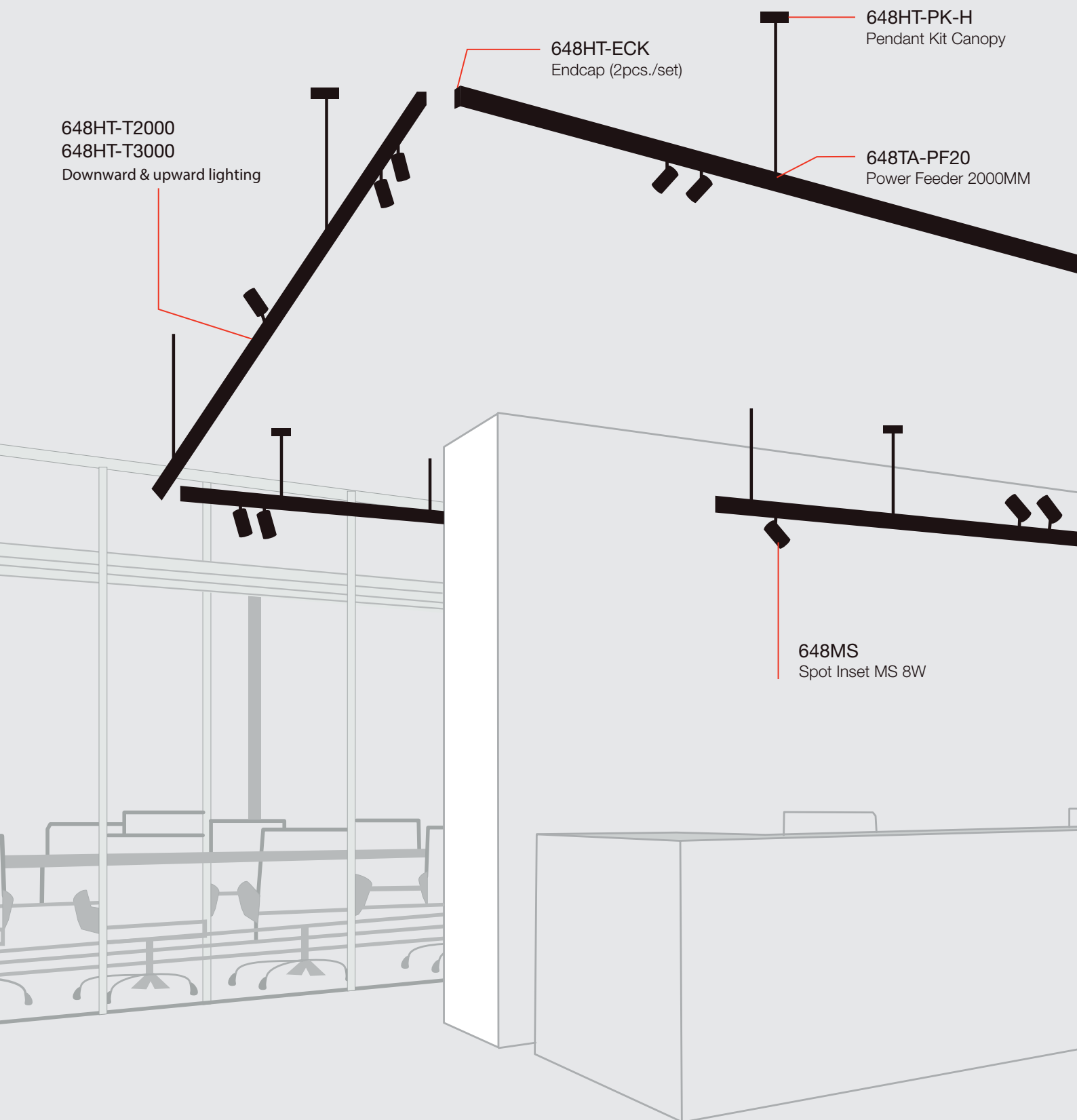

648HT-LCPK
Linear Connector Inkl Pendant Kit

648HT-LMC
Linear Mechanical Connector

648HT-SK
Suspension Kit

648HT-FECK
Flex Electrical Connector

648MD
Spot Inset MD 16W

LINE48V

H-TRACK | H-TRACK | H-TRACK



LINE48V ist die modulare 48V-Niedervolt-Systemlösung mit einem schlanken Designansatz, der auf ein 26 mm breites Aluminium-Strangpressprofil reduziert ist. Die doppelseitige H-TRACK mit einer Höhe von 90 mm bietet eine revolutionäre Pendellösung, bei der alle Einsätze von unten und oben installiert werden können. Alle LINE48V-Schienen sind in den Farben schwarz (RAL 9005) und weiß (RAL 9016) pulverbeschichtet erhältlich. Die Leuchteinsätze werden durch einen einfachen Einrastmechanismus mit dem Profil verbunden, der ein hohes Maß an Flexibilität ohne den Einsatz von Werkzeug bietet. Um das LINE48V-System optimal zu erweitern, bieten die geraden Verbinder eine Vielzahl von Gestaltungsmöglichkeiten für die H-Schiene.

LINE48V is the modular 48V Low Voltage System solution with a sleek design approach, which is reduced to a 26 mm wide extruded aluminium profile. The double-sided H-TRACK with the height of 90 mm provides a revolutionised pendant solution, where all the inserts can be installed from below and above. All LINE48V tracks are available in a powder-coated black (RAL 9005) and white (RAL 9016) finish. The light inserts will be connected to the profile by a simple click-in mechanism, which offers a high degree of flexibility without using any tools. To extend the LINE48V system to its maximum, straight line connectors are providing a numerous design options for the H-Track.

LINE48V est la solution modulaire de système basse tension 48V au design épuré, réduite à un profilé d'aluminium extrudé de 26 mm de large. Le rail H double face d'une hauteur de 90 mm offre une solution suspendue révolutionnaire, où tous les inserts peuvent être installés par le bas et par le haut. Tous les rails LINE48V sont disponibles en noir (RAL 9005) et blanc (RAL 9016) avec revêtement par poudre. Les modules d'éclairage sont reliés au profilé par un simple mécanisme d'encliquetage, qui offre un haut degré de flexibilité sans aucun outil. Pour étendre au maximum le système LINE48V, les connecteurs de ligne droite offrent de nombreuses options de conception pour le rail en H.

ÜBERSICHT | OVERVIEW | VUE D'ENSEMBLE

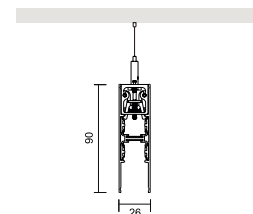

colour	housing material	dimensions [mm]	weight [kg]	material number
■ black [RAL 9005]	aluminium	L 2000 / W 26 / H 90	2,80	648HT-T2000-B
□ white [RAL 9016]	aluminium	L 2000 / W 26 / H 90	2,80	648HT-T2000-W
■ black [RAL 9005]	aluminium	L 3000 / W 26 / H 90	4,20	648HT-T3000-B
□ white [RAL 9016]	aluminium	L 3000 / W 26 / H 90	4,20	648HT-T3000-W

ACCESSORIES BLACK	
648HT-ECK-B	
648HT-LMC-B	
648HT-LCPK	
648HT-SK	
648HT-PK-H-B	

ACCESSORIES WHITE	
648BT-ECK-W	
648BT-LC-W	

- All article numbers of the accessories can be found on p. 272 and 273.
- Corners incl. flexible continuous electrical kit.



LINE48V

FRAME TRACK | FRAME TRACK | FRAME TRACK

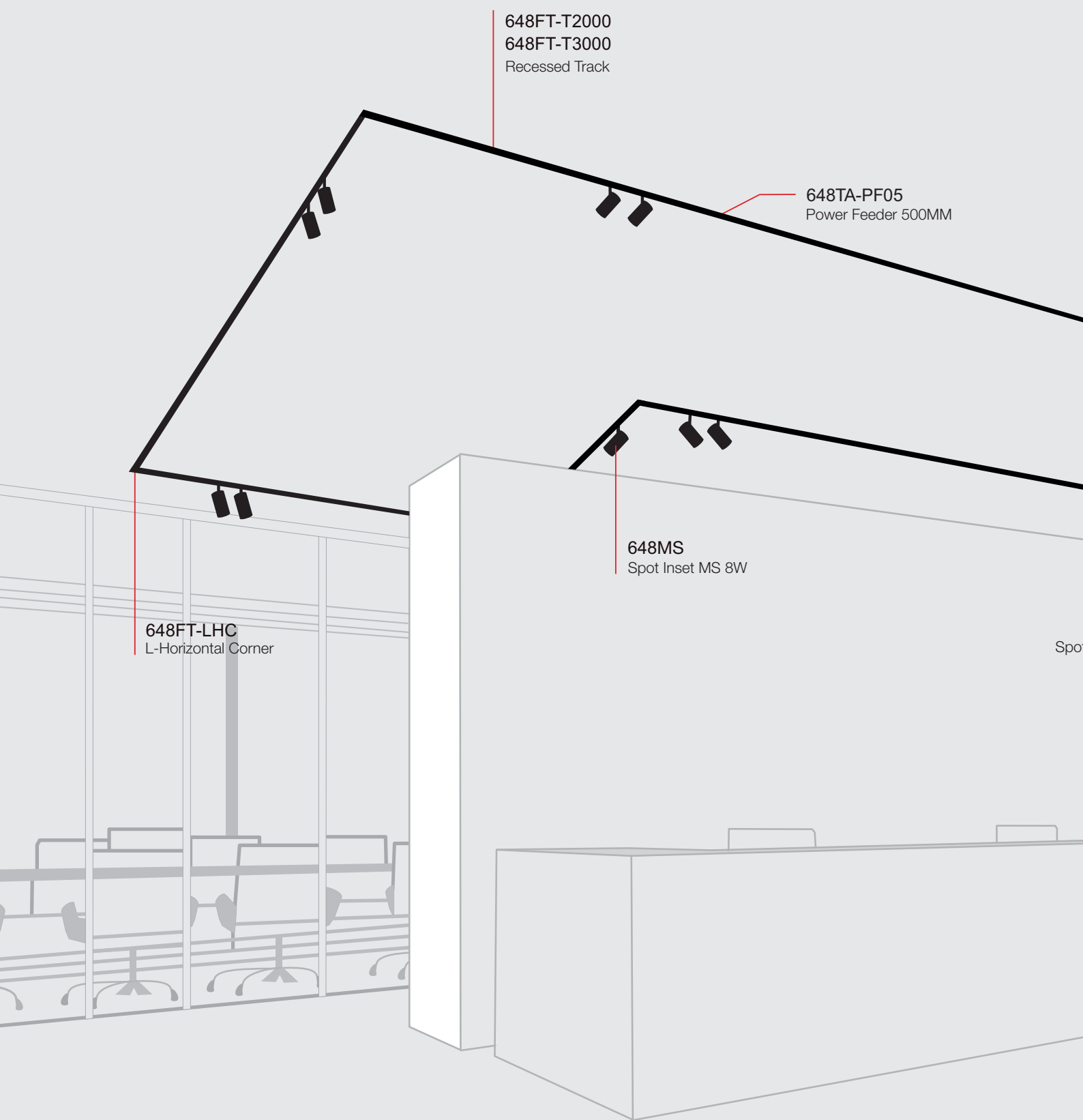

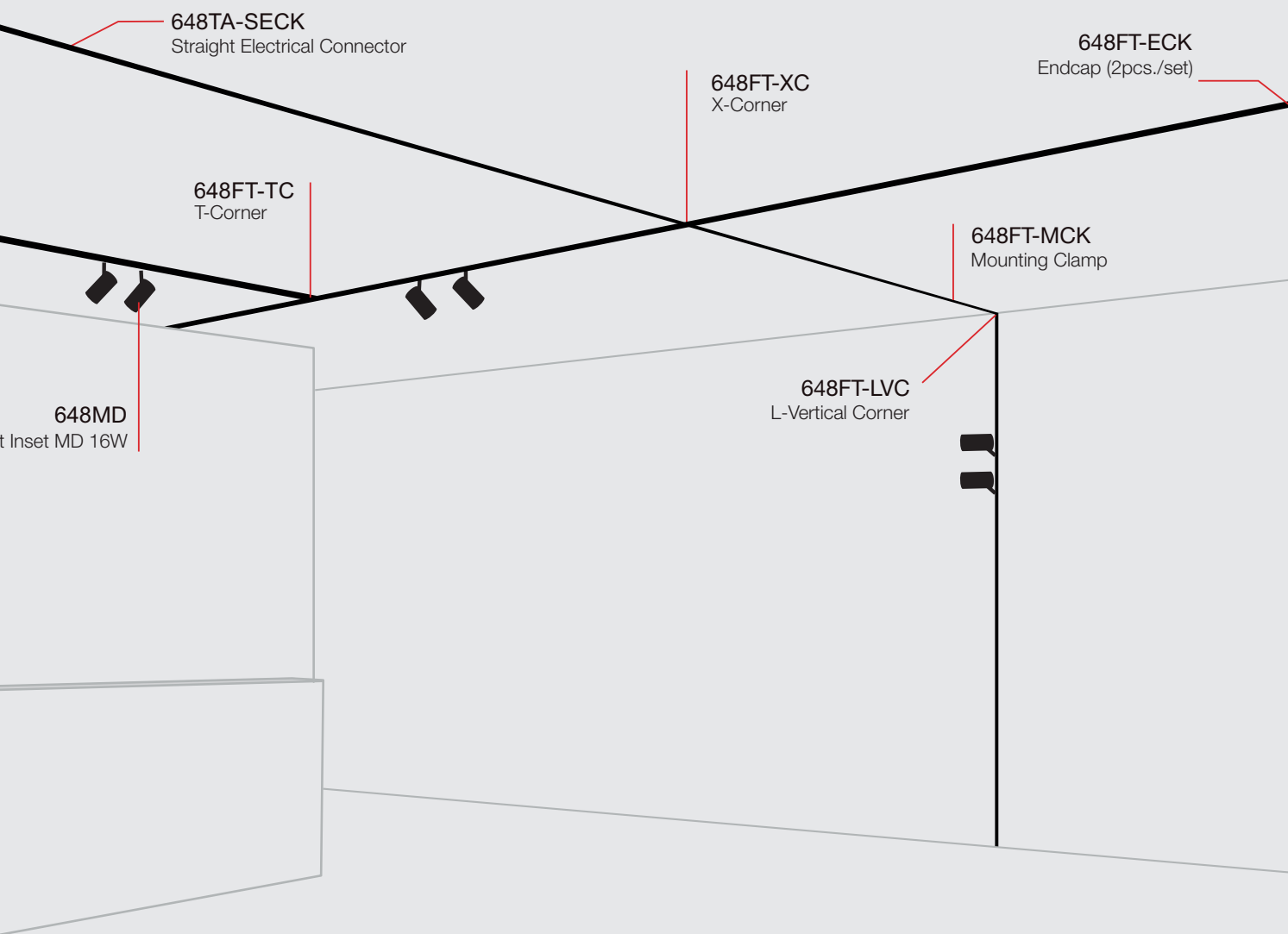

LINE48V

FRAME TRACK | FRAME TRACK | FRAME TRACK



LINE48V ist die modulare 48V-Niedervolt-Systemlösung mit einem schlanken Designansatz, der auf ein 26 mm breites inneres Aluminium-Strangpressprofil reduziert ist. Die FRAME TRACK mit einer äußeren Profilbreite von 36 mm ermöglicht ideale Lösungen für den Deckeneinbau. Alle LINE48V Schienen sind in den Farben schwarz (RAL 9005) und weiß (RAL 9016) pulverbeschichtet erhältlich. Die Lichteinsätze werden durch einen einfachen Einrastmechanismus mit dem Profil verbunden, der ein hohes Maß an Flexibilität ohne den Einsatz von Werkzeug bietet. Um das LINE48V-System optimal zu erweitern, bieten verschiedene Verbinder in I-, L-, T- oder X-Form eine Vielzahl von Gestaltungsmöglichkeiten.

LINE48V is the modular 48V Low Voltage System solution with a sleek design approach, which is reduced to a 26 mm inner profile wide extruded aluminium profile. The FRAME TRACK with the outer profile width of 36 mm allows ideal solutions for recessed installation. All LINE48V tracks are available in a powder-coated black (RAL 9005) and white (RAL 9016) finish. The light inserts will be connected to the profile by a simple click-in mechanism, which offers a high degree of flexibility without using any tools. To extend the LINE48V system to its maximum, different connectors in I, L, T or X-shape are providing a numerous design options.

LINE48V est la solution modulaire de système basse tension 48V avec une approche de conception élégante, qui est réduite à un profil intérieur de 26 mm de large en aluminium extrudé. Le rail FRAME, avec un profil extérieur de 36 mm de large, offre des solutions idéales pour les installations encastrées. Tous les rails LINE48V sont disponibles en noir (RAL 9005) et blanc (RAL 9016) avec revêtement par poudre. Les modules d'éclairage seront connectés au profilé par un simple mécanisme d'encliquetage, ce qui offre un haut degré de flexibilité sans utiliser d'outils. Pour étendre au maximum le système LINE48V, différents connecteurs en I, L, T ou X offrent de nombreuses possibilités de conception.

ÜBERSICHT | OVERVIEW | VUE D'ENSEMBLE

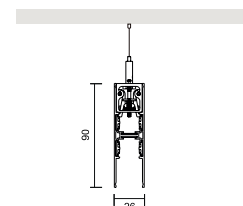

colour	housing material	dimensions [mm]	weight [kg]	material number
■ black [RAL 9005]	aluminium	L 2000 / W 38 / H 52	2,40	648FT-T2000-B
□ white [RAL 9016]	aluminium	L 2000 / W 38 / H 52	2,40	648FT-T2000-W
■ black [RAL 9005]	aluminium	L 3000 / W 38 / H 52	3,60	648FT-T3000-B
□ white [RAL 9016]	aluminium	L 3000 / W 38 / H 52	3,60	648FT-T3000-W

ACCESSORIES BLACK

648FT-ECK-B	
648FT-LHC-B	
648FT-LVC-B	
648FT-TC-B	
648FT-XC-B	
648FT-MCK	

ACCESSORIES WHITE

648FT-ECK-W	
648FT-LHC-W	
648FT-LVC-W	
648FT-TC-W	
648FT-XC-W	

- All article numbers of the accessories can be found on **p. 272** and **273**.
- Corners incl. flexible continuous electrical kit.

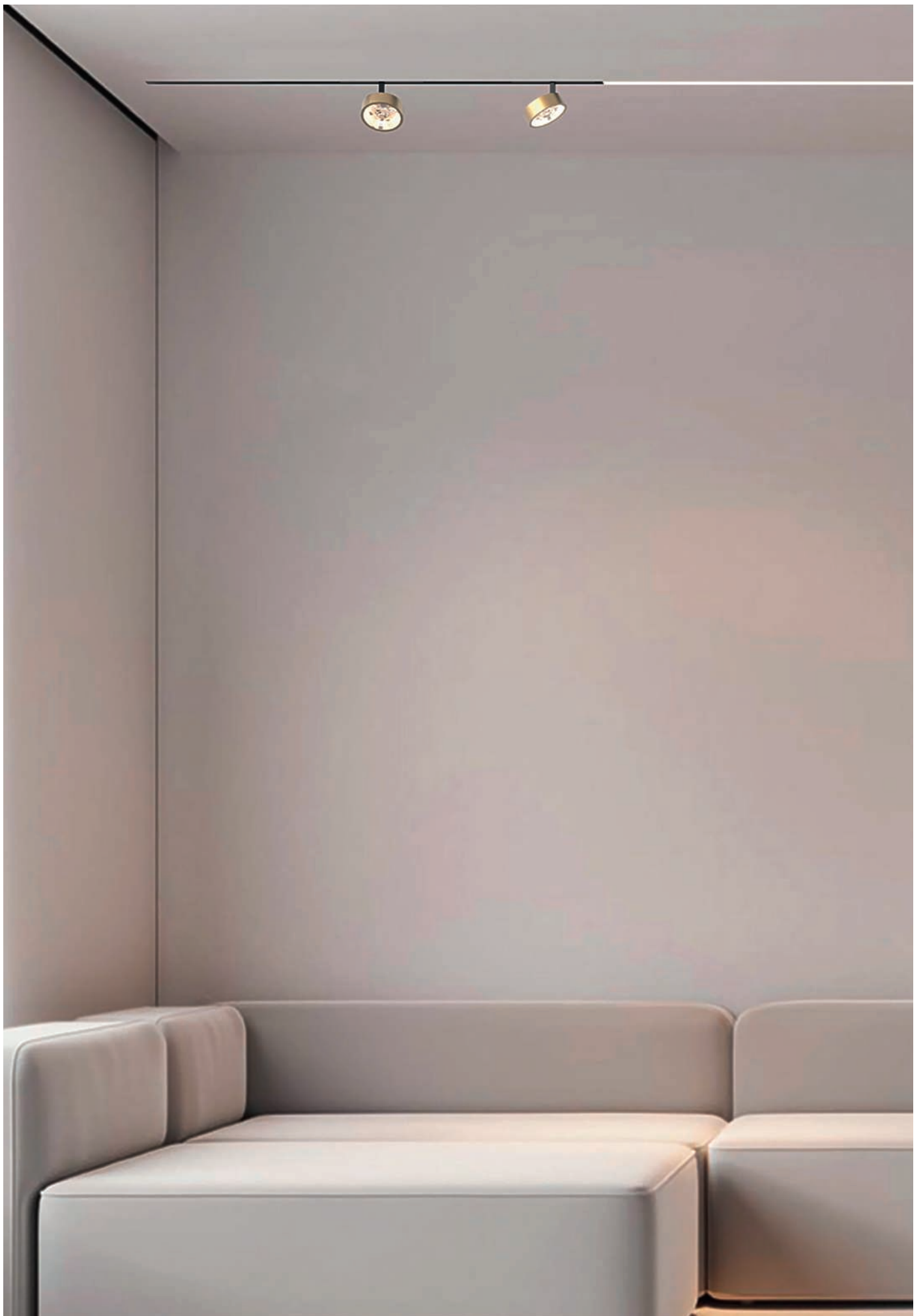

LINE48V

FRAMELESS TRACK | FRAMELESS TRACK | *FRAMELESS TRACK*

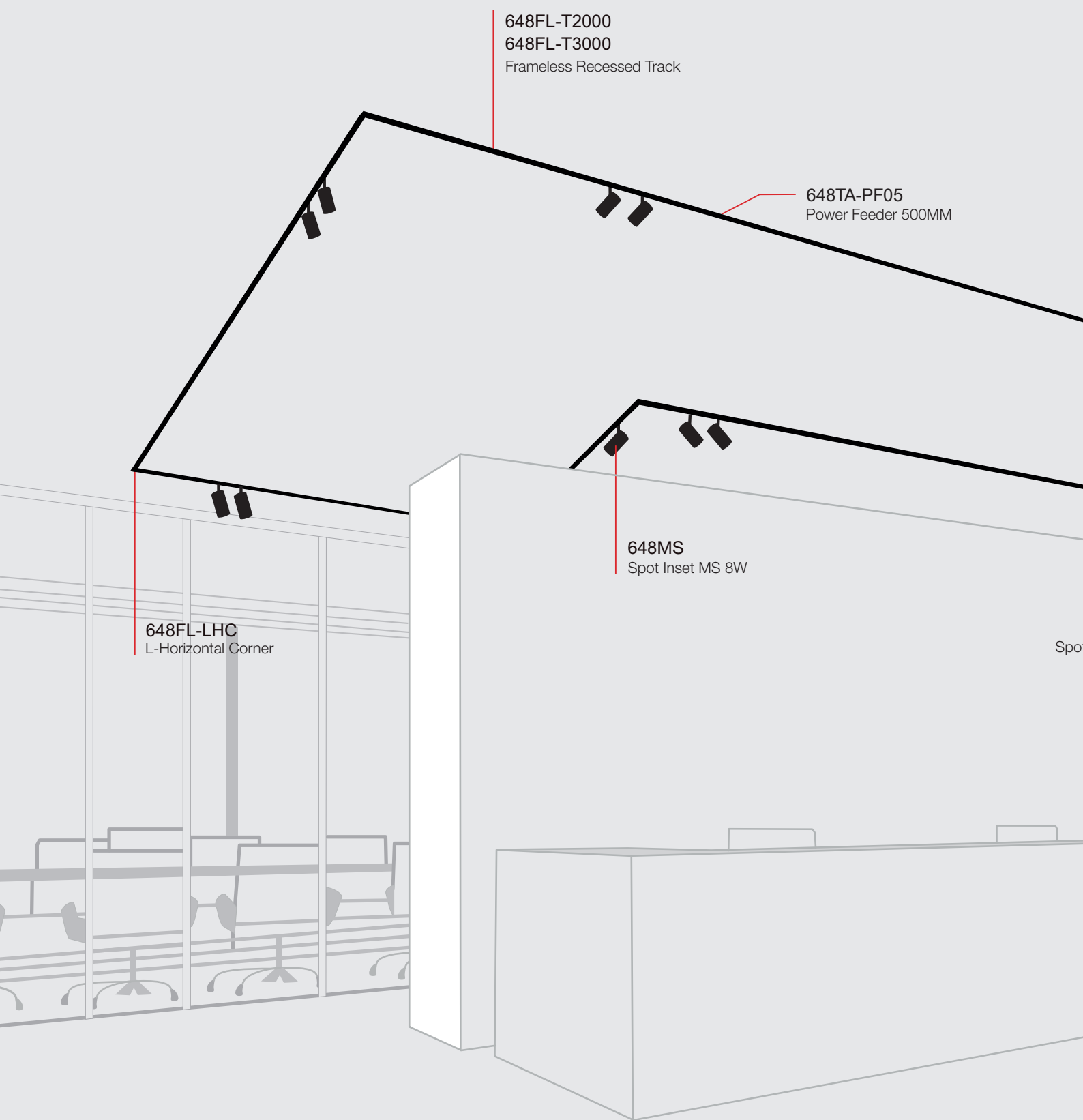

648FL-T2000
648FL-T3000
Frameless Recessed Track

648TA-PF05
Power Feeder 500MM

648MS
Spot Inset MS 8W

648FL-LHC
L-Horizontal Corner

Spot

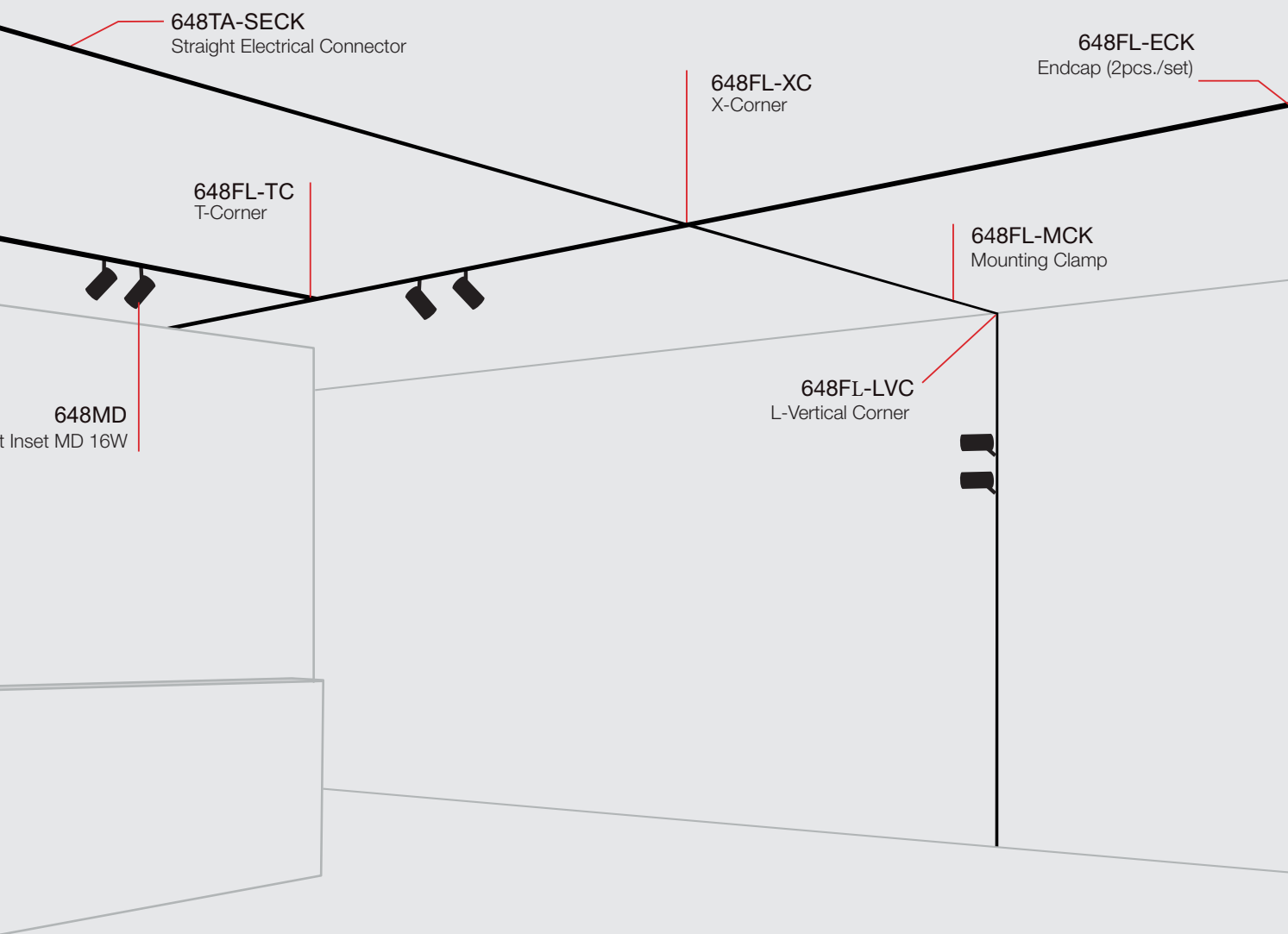

648TA-SECK
Straight Electrical Connector

648FL-XC
X-Corner

648FL-ECK
Endcap (2pcs./set)

648FL-TC
T-Corner

648FL-MCK
Mounting Clamp

648MD
Inset MD 16W

648FL-LVC
L-Vertical Corner

LINE48V

FRAMELESS TRACK | FRAMELESS TRACK | FRAMELESS TRACK

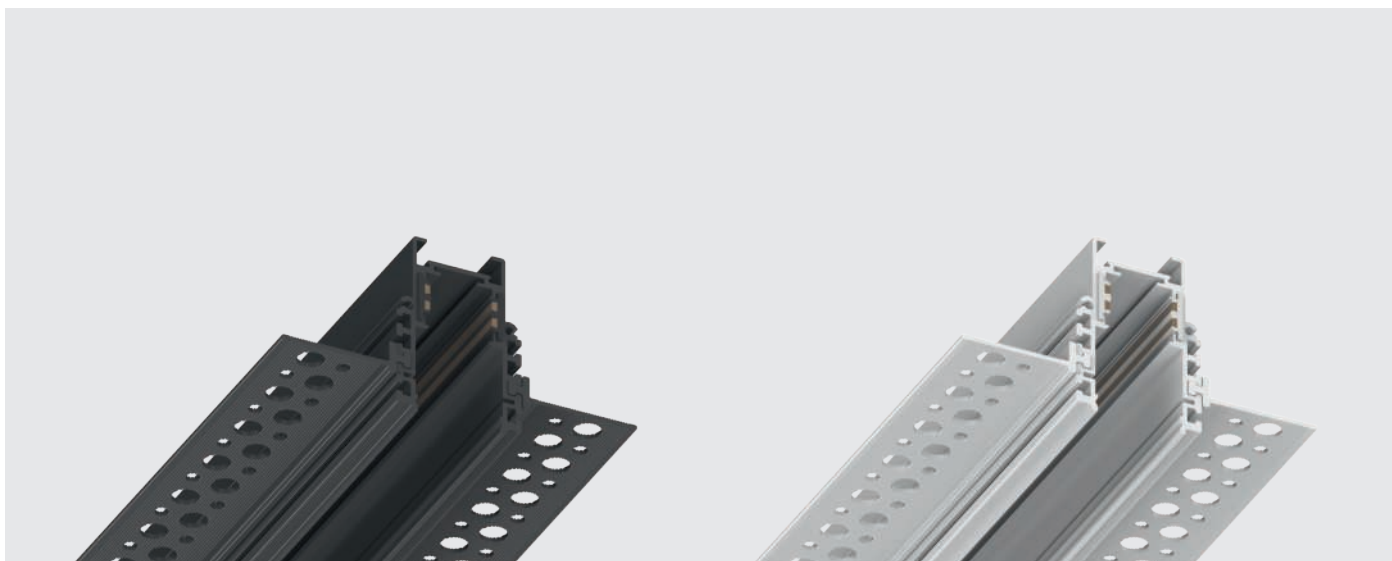

LINE48V ist die modulare 48V-Niedervolt-Systemlösung mit einem schlanken Designansatz, der auf ein 26 mm breites Aluminium-Strangpressprofil reduziert ist. Die FRAMELESS TRACK ermöglicht ideale Lösungen für den rahmenlosen Einbau mit einem nahtlosen Übergang zwischen dem Profil und der Decke. Alle LINE48V-Schienen sind in den Farben schwarz (RAL 9005) und weiß (RAL 9016) pulverbeschichtet erhältlich. Die Leuchteinsätze werden durch einen einfachen Einrastmechanismus mit dem Profil verbunden, der ein hohes Maß an Flexibilität ohne den Einsatz von Werkzeug bietet. Um das LINE48V-System optimal zu erweitern, bieten verschiedene Verbinder in I-, L-, T- oder X-Form eine Vielzahl von Gestaltungsmöglichkeiten.

LINE48V is the modular 48V Low Voltage System solution with a sleek design approach, which is reduced to a 26 mm inner profile wide extruded aluminium profile. The FRAMELESS TRACK allows ideal solutions for trimless recessed installation with a seamless transition between the profile and the ceiling. All LINE48V tracks are available in a powder-coated black (RAL 9005) and white (RAL 9016) finish. The light inserts will be connected to the profile by a simple click-in mechanism, which offers a high degree of flexibility without using any tools. To extend the LINE48V system to its maximum, different connectors in I, L, T or X-shape are providing a numerous design options.

LINE48V est la solution modulaire de système basse tension de 48V avec une approche de conception élégante, qui est réduite à un profil intérieur de 26 mm de large en aluminium extrudé. Le rail FRAMELESS TRACK offre des solutions idéales pour les installations encastrées sans garniture, avec une transition transparente entre le profil et le plafond. Tous les rails LINE48V sont disponibles en noir (RAL 9005) et blanc (RAL 9016) avec revêtement par poudre. Les modules d'éclairage sont reliés au profilé par un simple mécanisme d'encliquetage, ce qui offre un haut degré de flexibilité sans aucun outil. Pour étendre au maximum le système LINE48V, différents connecteurs en forme de I, L, T ou X offrent de nombreuses possibilités de conception.

ÜBERSICHT | OVERVIEW | VUE D'ENSEMBLE

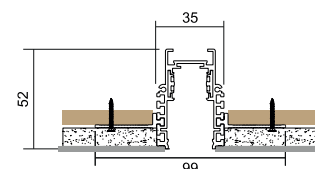

colour	housing material	dimensions [mm]	weight [kg]	material number
■ black [RAL 9005]	aluminium	L 2000 / W 35 / H 52	2,60	648FL-T2000-B
□ white [RAL 9016]	aluminium	L 2000 / W 35 / H 52	2,60	648FL-T2000-W
■ black [RAL 9005]	aluminium	L 3000 / W 35 / H 52	3,80	648FL-T3000-B
□ white [RAL 9016]	aluminium	L 3000 / W 35 / H 52	3,80	648FL-T3000-W

ACCESSORIES BLACK

648FT-ECK-B	
648FT-LHC-B	
648FT-LVC-B	
648FT-TC-B	
648FT-XC-B	
648FT-MCK	

ACCESSORIES WHITE

648FT-ECK-W	
648FT-LHC-W	
648FT-LVC-W	
648FT-TC-W	
648FT-XC-W	

- All article numbers of the accessories can be found on **p. 272 and 273**.
- Corners incl. flexible continuous electrical kit.



LINE48V

ZUBEHÖR | ACCESSORIES | ACCESSORIES



Track type	description	Colour	Housing material	dimensions [mm]	cable length [mm]	weight [kg]	Material Number
SLIM TRACK 648ST	L-CONNECTOR HORIZONTAL	■ black [RAL 9005]	aluminium	L 73 / W 73 / H 27	-	0,16	648ST-LC-B
	L-CONNECTOR HORIZONTAL	□ white [RAL 9016]	aluminium	L 73 / W 73 / H 27	-	0,16	648ST-LC-W
	T-CONNECTOR	■ black [RAL 9005]	aluminium	L 96 / W 61 / H 26	-	0,18	648ST-METC-B
	T-CONNECTOR	□ white [RAL 9016]	aluminium	L 96 / W 61 / H 26	-	0,18	648ST-METC-W
	X-CONNECTOR	■ black [RAL 9005]	aluminium	L 96 / W 96 / H 26	-	0,18	648ST-MEXC-B
	X-CONNECTOR	□ white [RAL 9016]	aluminium	L 96 / W 96 / H 26	-	0,18	648ST-MEXC-W
	L-CORNER VERTICAL	■ black [RAL 9005]	aluminium	L 100 / W 100 / H 26	-	0,16	648ST-LVC-B
	L-CORNER VERTICAL	□ white [RAL 9016]	aluminium	L 100 / W 100 / H 26	-	0,16	648ST-LVC-W
	ENDCAP SET [2 PCS/SET]	■ black [RAL 9005]	plastic	L 27 / W 26 / H 11	-	0,03	648ST-ECK-B
	ENDCAP SET [2 PCS/SET]	□ white [RAL 9016]	plastic	L 27 / W 26 / H 11	-	0,03	648ST-ECK-W
	COVER	■ black [RAL 9005]	plastic	L 2000 / W 18 / H 17	-	0,18	648ST-PC2000-B
	COVER	□ white [RAL 9016]	plastic	L 2000 / W 18 / H 17	-	0,18	648ST-PC2000-W
BASIC TRACK 648BT	L-CONNECTOR HORIZONTAL	■ black [RAL 9005]	aluminium	L 73 / W 73 / H 52	-	0,17	648BT-LC-B
	L-CONNECTOR HORIZONTAL	□ white [RAL 9016]	aluminium	L 73 / W 73 / H 52	-	0,17	648BT-LC-W
	T-CONNECTOR	■ black [RAL 9005]	aluminium	L 96 / W 61 / H 52	-	0,19	648BT-TC-B
	T-CONNECTOR	□ white [RAL 9016]	aluminium	L 96 / W 61 / H 52	-	0,19	648BT-TC-W
	X-CONNECTOR	■ black [RAL 9005]	aluminium	L 96 / W 96 / H 52	-	0,19	648BT-XC-B
	X-CONNECTOR	□ white [RAL 9016]	aluminium	L 96 / W 96 / H 52	-	0,19	648BT-XC-W
	L-CORNER VERTICAL	■ black [RAL 9005]	aluminium	L 80 / W 80 / H 26	-	0,17	648BT-LVC-B
	L-CORNER VERTICAL	□ white [RAL 9016]	aluminium	L 80 / W 80 / H 26	-	0,17	648BT-LVC-W
	ENDCAP SET [2 PCS/SET]	■ black [RAL 9005]	plastic	L 52 / W 26 / H 11	-	0,04	648BT-ECK-B
	ENDCAP SET [2 PCS/SET]	□ white [RAL 9016]	plastic	L 52 / W 26 / H 11	-	0,04	648BT-ECK-W
SLIM / BASIC TRACK	PENDANT SET [2 PCS/SET]	■ black [RAL 9005]	aluminium	L 33 / W 24 / H 8	-	0,07	648TA-SK-B
	SET [2 PCS/SET] INCL. CANOPY	■ black [RAL 9005]	metal	L 100 / W 55 / H 30	2000	0,31	648TA-PIK-B
	PENDANT SET [2 PCS/SET] INCL. CANOPY	□ white [RAL 9016]	metal	L 100 / W 55 / H 30	2000	0,31	648TA-PIK-W
	MECH. CONNECTION SET	■ black [RAL 9005]	aluminium	L 60 / W 24 / H 2	-	0,08	648TA-MLC-B

CORNERS / CONNECTORS INCL. FLEXIBLE CONTINUOUS KIT ELECTRICAL

Track type	description	Colour	Housing material	dimensions [mm]	cable length [mm]	weight [kg]	Material Number
H-TRACK 648HT	MECH. CONNECTION SET	■ black [RAL 9005]	aluminium	L 115 / W 23 / H 25	-	0,08	648HT-LMC-B
	CONNECTOR WITH PENDANT SET	■ black [RAL 9005]	aluminium	L 115 / W 23 / H 25	2000	0,09	648HT-LCPK
	PENDANT SET [2 PCS/SET]	■ black [RAL 9005]	aluminium	L 45 / W 23 / H 25	2000	0,09	648HT-SK
	PENDANT SET [1PCS/SET] INCL. CANOPY	■ black [RAL 9005]	aluminium	L 45 / W 23 / H 25	2000	0,34	648HT-PK-H-B
	PENDANT SET [1PCS/SET] INCL. CANOPY	□ white [RAL 9016]	aluminium	L 45 / W 23 / H 25	2000	0,34	648HT-PK-H-W
	FLEX. ELECTRICAL CONNECTION SET	■ black [RAL 9005]	plastic	L 95 / W 17 / H 16	-	0,06	648HT-FECK-B
	FLEX. ELECTRICAL CONNECTION SET	□ white [RAL 9016]	plastic	L 95 / W 17 / H 16	-	0,06	648HT-FECK-W
	ENDCAP SET [2 PCS/SET]	■ black [RAL 9005]	aluminium	L 90 / W 26 / H 15	-	0,05	648HT-ECK-B
	ENDCAP SET [2 PCS/SET]	□ white [RAL 9016]	aluminium	L 90 / W 26 / H 15	-	0,05	648HT-ECK-W
RECESSED FRAME TRACK 648FT	L-CORNER HORIZONTAL	■ black [RAL 9005]	aluminium	L 80 / W 80 / H 52	-	0,33	648FT-LHC-B
	L-CORNER HORIZONTAL	□ white [RAL 9016]	aluminium	L 80 / W 80 / H 52	-	0,33	648FT-LHC-W
	L-CORNER VERTICAL	■ black [RAL 9005]	aluminium	L 80 / W 80 / H 38	-	0,33	648FT-LVC-B
	L-CORNER VERTICAL	□ white [RAL 9016]	aluminium	L 80 / W 80 / H 38	-	0,33	648FT-LVC-W
	T-CONNECTOR	■ black [RAL 9005]	aluminium	L 120 / W 80 / H 38	-	0,35	648FT-TC-B
	T-CONNECTOR	□ white [RAL 9016]	aluminium	L 120 / W 80 / H 38	-	0,35	648FT-TC-W
	X-CONNECTOR	■ black [RAL 9005]	aluminium	L 120 / W 120 / H 38	-	0,35	648FT-XC-B
	X-CONNECTOR	□ white [RAL 9016]	aluminium	L 120 / W 120 / H 38	-	0,35	648FT-XC-W
	ENDCAP SET [2 PCS/SET]	■ black [RAL 9005]	plastic	L 38 / W 13 / H 52	-	0,04	648FT-ECK-B
	ENDCAP SET [2 PCS/SET]	□ white [RAL 9016]	plastic	L 38 / W 13 / H 52	-	0,04	648FT-ECK-W
	MOUNTING CLAMP [2 PCS]]	■ silver	aluminium	L 72 / W 20 / H 55	-	0,1	648FT-MCK
RECESSED FRAMELESS TRACK 648FL	L-CORNER HORIZONTAL	■ black [RAL 9005]	aluminium	L 100 / W 100 / H 52	-	0,33	648FL-LHC-B
	L-CORNER HORIZONTAL	□ white [RAL 9016]	aluminium	L 100 / W 100 / H 52	-	0,33	648FL-LHC-W
	L-CORNER VERTICAL	■ black [RAL 9005]	aluminium	L 100 / W 100 / H 52	-	0,33	648FL-LVC-B
	L-CORNER VERTICAL	□ white [RAL 9016]	aluminium	L 100 / W 100 / H 52	-	0,33	648FL-LVC-W
	T-CONNECTOR	■ black [RAL 9005]	aluminium	L 120 / W 100 / H 52	-	0,35	648FL-TC-B
	T-CONNECTOR	□ white [RAL 9016]	aluminium	L 120 / W 100 / H 52	-	0,35	648FL-TC-W
	X-CONNECTOR	■ black [RAL 9005]	aluminium	L 120 / W 120 / H 52	-	0,35	648FL-XC-B
	X-CONNECTOR	□ white [RAL 9016]	aluminium	L 120 / W 120 / H 52	-	0,35	648FL-XC-W
	ENDCAP SET [2 PCS/SET]	■ black [RAL 9005]	plastic	L 56 / W 26 / H 2	-	0,04	648FL-ECK-B
	ENDCAP SET [2 PCS/SET]	□ white [RAL 9016]	plastic	L 56 / W 26 / H 2	-	0,04	648FL-ECK-W
	MOUNTING CLAMP [2 PCS]]	■ black [RAL 9005]	aluminium	L 120 / W 36 / H 9	-	0,1	648FL-MCK
FOR ALL TRACKS	POWERFEEDER UNIT WITH CABLE	■ black [RAL 9005]	plastic	L 97 / W 17 / H 16	500	0,05	648TA-PF05-B
	POWERFEEDER UNIT WITH CABLE	□ white [RAL 9016]	plastic	L 97 / W 17 / H 16	500	0,05	648TA-PF05-W
	POWERFEEDER UNIT WITH CABLE	■ black [RAL 9005]	plastic	L 97 / W 17 / H 16	2000	0,05	648TA-PF20-B
	POWERFEEDER UNIT WITH CABLE	□ white [RAL 9005]	plastic	L 97 / W 17 / H 16	2000	0,05	648TA-PF20-W
	FLEXIBLE ELECTRICAL CONNECTION	■ black [RAL 9005]	plastic	L 229 / W 16 / H 17	-	0,05	648TA-FECK-B
	FLEXIBLE ELECTRICAL CONNECTION SET	□ white [RAL 9016]	plastic	L 229 / W 16 / H 17	-	0,05	648TA-FECK-W
	STRAIGHT ELECTRICAL CONNECTION SET	■ black [RAL 9005]	plastic	L 144 / W 16 / H 17	-	0,05	648TA-SECK-B
	RIGID ELECTRICAL CONNECTION SET	□ white [RAL 9016]	plastic	L 144 / W 16 / H 17	-	0,05	648TA-SECK-W
	COVER FOR 648BT/648HT/648FT/648FL TRACK	■ black [RAL 9005]	aluminium	L 2000 / W 24 / H 5	-	0,17	648TA-AC2000-B
	COVER FOR 648BT/648HT/648FT/648FL TRACK	□ white [RAL 9016]	aluminium	L 2000 / W 24 / H 6	-	0,17	648TA-AC2000-W

CORNERS / CONNECTORS INCL. FLEXIBLE CONTINUOUS KIT ELECTRICAL

OVERVIEW

LEUCHTEN & TREIBER | LUMINAIRES & DRIVERS | *LUMINAIRES & DRIVER*

LEUCHTEN | LUMINAIRES | *LUMINAIRES*



MEDIUM SPOT
276



MEDIUM SPOT
277



ZOOM SPOT
278



FLAT SPOT
279



FIXED SPOT
280



FIXED SPOT
284



LENS MODULE
288



OPAL MODULE
289



PRISM MODULE
290

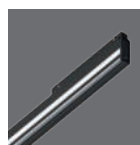

WALL WASHER
291



PIEDALE
292



CANALELLO
294



TORTORETO
296

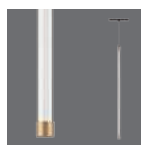

ROBE
297

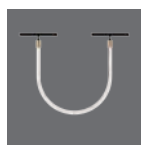

ROBE
298

TREIBER | DRIVERS | *DRIVER*



IN-TRACK 100 W
300



IN-TRACK 250 W
300

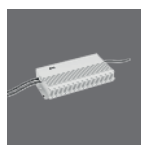

320 / 480 W
301



SIGNAL CONTROLLER
301

LEUCHTEN & TREIBER

LUMINAIRES & DRIVERS

LUMINAIRES & DRIVER

LINE48V

MEDIUM SPOT | MEDIUM SPOT | MEDIUM SPOT

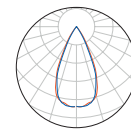

Die leistungsstarken und blendfreien Einzel Medium Spots für das modulare LINE48V Niedervolt-System mit Ø 40 mm Durchmesser versprechen eine Vielzahl von unterschiedlichen Konfigurationsmöglichkeiten. Die Farbtemperatur ist in 2700K, 3000K und 4000K wählbar und passt sich mit einem Farbwiedergabeindex >90 perfekt an höchste Anforderungen an. Die Lichteinsätze werden durch einen einfachen Klickmechanismus mit dem Profil verbunden, was ein hohes Maß an Flexibilität ohne den Einsatz von Werkzeug bietet. Um den Anforderungen professioneller Beleuchtungsaufgaben gerecht zu werden, können die Medium Spots sowohl mit on/off, als auch mit DALI-Treibern gewählt werden.

The powerful and glare-free Single cylindrical Medium Spot with Ø 40 mm diameter for the modular LINE48V Low Voltage promises a variety of different configurations options. The color temperature is available in 2700K, 3000K and 4000K and can be adapted to your requirements with a color rendering index >90. The light inserts will be connected to the profile by a simple click-in mechanism, which offers a high degree of flexibility without using any tools. To meet the requirements of professional lighting task, the Medium Spotlights can be selected with on/off as well as with DALI dimmable drivers.

Puissants et anti-éblouissants, les spots Medium simples pour le système modulaire LINE48V basse tension de Ø 40 mm de diamètre promettent une multitude de configurations différentes. La température de couleur est sélectionnable en 2700K, 3000K et 4000K et s'adapte parfaitement aux exigences les plus élevées avec un indice de rendu des couleurs >90. Les inserts d'éclairage sont reliés au profilé par un simple mécanisme d'encliquetage, ce qui offre une grande flexibilité sans avoir recours à des outils. Pour répondre aux exigences des tâches d'éclairage professionnelles, les Medium Spots peuvent être choisis avec des pilotes on/off ou DALI.

ÜBERSICHT | OVERVIEW | VUE D'ENSEMBLE

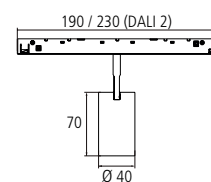

dimmable	colour	dimensions [mm]	colour temp. [K]	luminous flux [lm]	weight [kg]	material number
✗	■ black [RAL 9005]	Ø 40 / L 190 / H 130	2700	395	0,17	648MS-459271-OOBLB
	□ white [RAL 9016]	Ø 40 / L 190 / H 130	2700	395	0,17	648MS-459271-OOWHB
	■ black [RAL 9005]	Ø 40 / L 190 / H 130	3000	586	0,17	648MS-459301-OOBLB
	□ white [RAL 9016]	Ø 40 / L 190 / H 130	3000	586	0,17	648MS-459301-OOWHB
	■ black [RAL 9005]	Ø 40 / L 190 / H 130	4000	655	0,17	648MS-459401-OOBLB
	□ white [RAL 9016]	Ø 40 / L 190 / H 130	4000	655	0,17	648MS-459401-OOWHB
DALI2	■ black [RAL 9005]	Ø 40 / L 230 / H 130	2700	395	0,17	648MS-459271-DDBLB
	□ white [RAL 9016]	Ø 40 / L 230 / H 130	2700	395	0,17	648MS-459271-DDWHB
	■ black [RAL 9005]	Ø 40 / L 230 / H 130	3000	586	0,17	648MS-459301-DDBLB
	□ white [RAL 9016]	Ø 40 / L 230 / H 130	3000	586	0,17	648MS-459301-DDWHB
	■ black [RAL 9005]	Ø 40 / L 230 / H 130	4000	655	0,17	648MS-459401-DDBLB
	□ white [RAL 9016]	Ø 40 / L 230 / H 130	4000	655	0,17	648MS-459401-DDWHB

LINE48V

MEDIUM SPOT | MEDIUM SPOT | MEDIUM SPOT

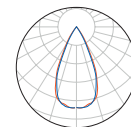

Die leistungsstarken und blendfreien Doppel Medium Spots für das modulare LINE48V Niedervolt-System mit Ø 40 mm Durchmesser versprechen eine Vielzahl von unterschiedlichen Konfigurationsmöglichkeiten. Die Farbtemperatur ist in 2700K, 3000K und 4000K wählbar und passt sich mit einem Farbwiedergabeindex >90 perfekt an höchste Anforderungen an. Die Lichteinsätze werden durch einen einfachen Klickmechanismus mit dem Profil verbunden, was ein hohes Maß an Flexibilität ohne den Einsatz von Werkzeug bietet. Um den Anforderungen professioneller Beleuchtungsaufgaben gerecht zu werden, können die Medium Spots sowohl mit on/off, als auch mit DALI-Treibern gewählt werden.

The powerful and glare-free Double cylindrical Medium Spot with Ø 40 mm diameter for the modular LINE48V Low Voltage promises a variety of different configurations options. The color temperature is available in 2700K, 3000K and 4000K and can be adapted to your requirements with a color rendering index >90. The light inserts will be connected to the profile by a simple click-in mechanism, which offers a high degree of flexibility without using any tools. To meet the requirements of professional lighting task, the Medium Spotlights can be selected with on/off as well as with DALI dimmable drivers.

Puissants et anti-éblouissants, les spots Medium doubles pour le système modulaire LINE48V basse tension de Ø 40 mm de diamètre promettent une multitude de configurations différentes. La température de couleur est sélectionnable en 2700K, 3000K et 4000K et s'adapte parfaitement aux exigences les plus élevées avec un indice de rendu des couleurs >90. Les inserts d'éclairage sont reliés au profilé par un simple mécanisme d'encliquetage, ce qui offre une grande flexibilité sans avoir recours à des outils. Pour répondre aux exigences des tâches d'éclairage professionnelles, les Medium Spots peuvent être choisis avec des pilotes on/off ou DALI.

ÜBERSICHT | OVERVIEW | VUE D'ENSEMBLE



2 x 8 W

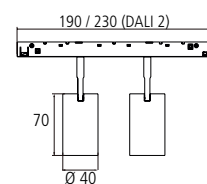

dimmable	colour	dimensions [mm]	colour temp. [K]	luminous flux [lm]	weight [kg]	material number
	■ black [RAL 9005]	Ø 40 / L 190 / H 130	2700	2 x 395	0,43	648MD-459271-OOBLB
	□ white [RAL 9016]	Ø 40 / L 190 / H 130	2700	2 x 395	0,43	648MD-459271-OOWHB
	■ black [RAL 9005]	Ø 40 / L 190 / H 130	3000	2 x 586	0,43	648MD-459301-OOBLB
	□ white [RAL 9016]	Ø 40 / L 190 / H 130	3000	2 x 586	0,43	648MD-459301-OOWHB
	■ black [RAL 9005]	Ø 40 / L 190 / H 130	4000	2 x 655	0,43	648MD-459401-OOBLB
	□ white [RAL 9016]	Ø 40 / L 190 / H 130	4000	2 x 655	0,43	648MD-459401-OOWHB
DALI 2	■ black [RAL 9005]	Ø 40 / L 230 / H 130	2700	2 x 395	0,43	648MD-459271-DDBLB
	□ white [RAL 9016]	Ø 40 / L 230 / H 130	2700	2 x 395	0,43	648MD-459271-DDWHB
	■ black [RAL 9005]	Ø 40 / L 230 / H 130	3000	2 x 586	0,43	648MD-459301-DDBLB
	□ white [RAL 9016]	Ø 40 / L 230 / H 130	3000	2 x 586	0,43	648MD-459301-DDWHB
	■ black [RAL 9005]	Ø 40 / L 230 / H 130	4000	2 x 655	0,43	648MD-459401-DDBLB
	□ white [RAL 9016]	Ø 40 / L 230 / H 130	4000	2 x 655	0,43	648MD-459401-DDWHB

LINE48V

ZOOM SPOT | ZOOM SPOT | ZOOM SPOT

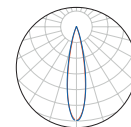

Der leistungsstarke und blendfreie Single-Zoom-Strahler mit Ø 55 mm Durchmesser für die modulare LINE48V Niedervolt-System verspricht eine Vielzahl von unterschiedlichen Konfigurationsmöglichkeiten. Die Farbtemperatur ist in 2700K, 3000K und 4000K erhältlich und kann mit einem Farbwiedergabeindex >90 an Ihre Anforderungen angepasst werden. Der LINE 48V Zoom Spot wird durch eine Variante mit optischem Zoom ergänzt, die es ermöglicht, jederzeit eine manuelle Anpassung der Abstrahlcharakteristik vorzunehmen. Die Lichteinsätze werden durch einen einfachen Einrastmechanismus mit dem Profil verbunden, was ein hohes Maß an Flexibilität ohne den Einsatz von Werkzeug bietet. Um den Anforderungen professioneller Beleuchtungsaufgaben gerecht zu werden, kann der Single Spotlight sowohl mit on/off- als auch mit DALI-Treibern gewählt werden.

The powerful and glare-free Single Zoom Spotlight with Ø 55 mm diameter for the modular LINE48V Low Voltage promises a variety of different configurations options. The color temperature is available in 2700K, 3000K and 4000K and can be adapted to your requirements with a color rendering index >90. LINE 48V Spot Inset MZ is complemented by a variant with an optical zoom, which makes it possible to make a manual adjustment of the beam characteristic at any time. The light inserts will be connected to the profile by a simple click-in mechanism, which offers a high degree of flexibility without using any tools. To meet the requirements of professional lighting task, the Single Spotlight can be selected with on/off as well as with DALI drivers.

Le projecteur puissant et non éblouissant à zoom unique d'un diamètre de 55 mm pour la LINE48V Low Voltage modulaire offre de nombreuses possibilités de configuration. La température de couleur est disponible en 2700K, 3000K et 4000K et peut être adaptée à vos besoins avec un indice de rendu des couleurs >90. LINE 48V Spot Inset MZ est complété par une variante avec zoom optique, qui permet d'effectuer un réglage manuel des caractéristiques du faisceau à tout moment. Les inserts lumineux seront connectés au profilé par un simple mécanisme d'encliquetage, ce qui offre un haut degré de flexibilité sans l'utilisation d'outils. Pour répondre aux exigences d'un éclairage professionnel, le Single Spotlight peut être sélectionné avec des pilotes on/off ou DALI.

ÜBERSICHT | OVERVIEW | VUE D'ENSEMBLE

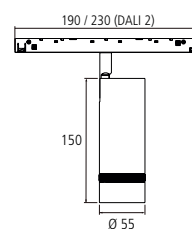

dimmable	colour	dimensions [mm]	colour temp. [K]	luminous flux [lm]	weight [kg]	material number
✗	■ black [RAL 9005]	Ø 55 / L 190 / H 200	2700	871	0,4	648MZ-ZO9271-OOBLB
	□ white [RAL 9016]	Ø 55 / L 190 / H 200	2700	871	0,4	648MZ-ZO9271-OOWHB
	■ black [RAL 9005]	Ø 55 / L 190 / H 200	3000	926	0,4	648MZ-ZO9301-OOBLB
	□ white [RAL 9016]	Ø 55 / L 190 / H 200	3000	926	0,4	648MZ-ZO9301-OOWHB
	■ black [RAL 9005]	Ø 55 / L 190 / H 200	4000	966	0,4	648MZ-ZO9401-OOBLB
	□ white [RAL 9016]	Ø 55 / L 190 / H 200	4000	966	0,4	648MZ-ZO9401-OOWHB
DALI 2	■ black [RAL 9005]	Ø 55 / L 230 / H 200	2700	871	0,4	648MZ-ZO9271-DDBLB
	□ white [RAL 9016]	Ø 55 / L 230 / H 200	2700	871	0,4	648MZ-ZO9271-DDWHB
	■ black [RAL 9005]	Ø 55 / L 230 / H 200	3000	926	0,4	648MZ-ZO9301-DDBLB
	□ white [RAL 9016]	Ø 55 / L 230 / H 200	3000	926	0,4	648MZ-ZO9301-DDWHB
	■ black [RAL 9005]	Ø 55 / L 230 / H 200	4000	966	0,4	648MZ-ZO9401-DDBLB
	□ white [RAL 9016]	Ø 55 / L 230 / H 200	4000	966	0,4	648MZ-ZO9401-DDWHB

LINE48V

FLAT SPOT | FLAT SPOT | FLAT SPOT

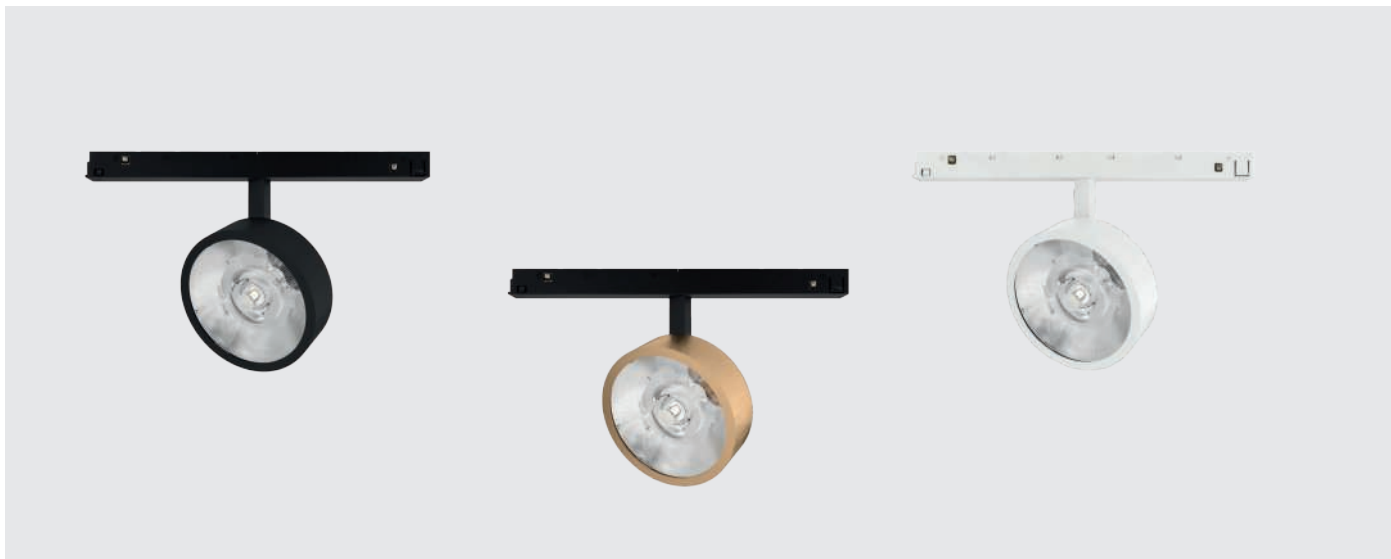
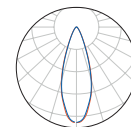

Der leistungsstarke Single Flat Spot mit Ø 96 mm Durchmesser für das modulare LINE48V Niedervolt-System verspricht eine Vielzahl von unterschiedlichen Konfigurationsmöglichkeiten. Die Farbtemperatur ist in 2700K, 3000K und 4000K erhältlich und kann mit einem Farbwiedergabeindex >90 an Ihre Anforderungen angepasst werden. Mit bis zu 858 Lumen bei einer minimalen Bauhöhe von nur 30mm, bietet der Flat Spot eine leistungsstarke Beleuchtungslösung. LINE48V Spotlight Inset SF ist in den Farben schwarz und weiß pulverbeschichtet, sowie in einer eleganten goldenen gebürsteten Oberfläche erhältlich. Die Lichteinsätze werden durch einen einfachen Einrastmechanismus mit dem Profil verbunden, der ein hohes Maß an Flexibilität ohne den Einsatz von Werkzeugen bietet. Um den Anforderungen professioneller Beleuchtungsaufgaben gerecht zu werden, kann der Single Spotlight sowohl mit on/off-, als auch mit DALI-Treibern gewählt werden.

The powerful Single Flat Spot with Ø 96 mm diameter for the modular 48V Low Voltage promises a variety of different configurations options. The color temperature is available in 2700K, 3000K and 4000K and can be adapted to your requirements with a color rendering index >90. With up to 858 lumens with a minimum height of just 30mm, the Flat Spot offers are powerful lighting solutions. LINE48V Spotlight Inset SF is available in a powder-coated black and white, as well as in an elegant golden brushed finish. The light inserts will be connected to the profile by a simple click-in mechanism, which offers a high degree of flexibility without using any tools. To meet the requirements of professional lighting task, the Single Spotlight can be selected with on/off as well as with DALI drivers.

Le puissant Single Flat Spot d'un diamètre de 96 mm pour le système modulaire 48V Low Voltage promet une variété de configurations différentes. La température de couleur est disponible en 2700K, 3000K et 4000K et peut être adaptée à vos besoins avec un indice de rendu des couleurs >90. Avec jusqu'à 858 lumens pour une hauteur minimale de seulement 30 mm, le Flat Spot offre des solutions d'éclairage puissantes. LINE48V Spot Inset SF est disponible en noir et blanc avec revêtement par poudre, ainsi que dans une élégante finition dorée brossée. Les inserts lumineux seront connectés au profilé par un simple mécanisme d'encliquetage, ce qui offre un haut degré de flexibilité sans l'utilisation d'outils. Pour répondre aux exigences d'un éclairage professionnel, le Single Spotlight peut être choisi avec des pilotes on/off ou DALI.

ÜBERSICHT | OVERVIEW | VUE D'ENSEMBLE

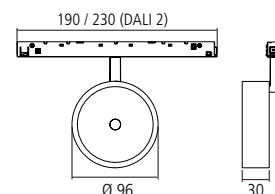

dimmable	colour	dimensions [mm]	colour temp. [K]	luminous flux [lm]	weight [kg]	material number
	■ black [RAL 9005]	Ø 96 / L 190 / H 141	2700	724	0,45	648SF-359271-OOBLB
	□ white [RAL 9016]	Ø 96 / L 190 / H 141	2700	724	0,45	648SF-359271-OOWHW
	■ gold	Ø 96 / L 190 / H 141	2700	724	0,45	648SF-359271-OOBLG
	■ black [RAL 9005]	Ø 96 / L 190 / H 141	3000	770	0,45	648SF-359301-OOBLB
	□ white [RAL 9016]	Ø 96 / L 190 / H 141	3000	770	0,45	648SF-359301-OOWHW
	■ gold	Ø 96 / L 190 / H 141	3000	770	0,45	648SF-359301-OOBLG
DALI 2	■ black [RAL 9005]	Ø 96 / L 190 / H 141	4000	858	0,45	648SF-359401-OOBLB
	□ white [RAL 9016]	Ø 96 / L 190 / H 141	4000	858	0,45	648SF-359401-OOWHW
	■ black [RAL 9005]	Ø 96 / L 230 / H 141	2700	724	0,45	648SF-359271-DDBLB
	□ white [RAL 9016]	Ø 96 / L 230 / H 141	2700	724	0,45	648SF-359271-DDWHW
	■ gold	Ø 96 / L 230 / H 141	2700	724	0,45	648SF-359271-DDBLG
	■ black [RAL 9005]	Ø 96 / L 230 / H 141	3000	770	0,45	648SF-359301-DDBLB
DALI 2	□ white [RAL 9016]	Ø 96 / L 230 / H 141	3000	770	0,45	648SF-359301-DDWHW
	■ gold	Ø 96 / L 230 / H 141	3000	770	0,45	648SF-359301-DDBLG
	■ black [RAL 9005]	Ø 96 / L 230 / H 141	4000	858	0,45	648SF-359401-DDBLB
	□ white [RAL 9016]	Ø 96 / L 230 / H 141	4000	858	0,45	648SF-359401-DDWHW

LINE48V

FIXED SPOT | FIXED SPOT | FIXED SPOT

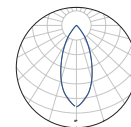

Die leistungsstarken und blendfreien Einzel Fixed Spots mit Ø 72 mm Durchmesser für das modulare LINE48V Niedervolt-System versprechen eine Vielzahl von unterschiedlichen Konfigurationsmöglichkeiten. Die Farbtemperatur ist in 2700K, 3000K und 4000K erhältlich und kann mit einem Farbwiedergabeindex >90 an Ihre Anforderungen angepasst werden. Durch den tiefen Einbau der LED in das Gehäuse bieten die LINE48V Fixed Spot Einsätze einen hohen Sehkomfort und eine blendfreie Ausleuchtung mit einem UGR-Wert <19. Darüber hinaus können pro Modell fünf verschiedenfarbige Reflektoren frei gewählt werden, um das perfekte Gestaltungselement für ein stimmungsvolles Ambiente zu schaffen. Die Lichteinsätze werden durch einen einfachen Einrastmechanismus mit dem Profil verbunden, der ein hohes Maß an Flexibilität ohne den Einsatz von Werkzeug bietet. Um den Anforderungen professioneller Beleuchtungsaufgaben gerecht zu werden, können die festen Spots sowohl mit on/off- als auch mit DALI-Treibern gewählt werden.

The powerful and glare-free Single Fixed Spots with Ø 72 mm diameter for the modular LINE48V Low Voltage System promises a variety of different configurations options. The color temperature is available in 2700K, 3000K and 4000K and can be adapted to your requirements with a color rendering index >90. Due to the fact that the LED is installed deep in the housing, the LINE48V Fixed Spot Inserts offer a high visual comfort and a glare-free illumination with a UGR value <19. Furthermore, five different colored reflectors can be freely selected per model to create the perfect design element for an atmospheric ambience. The light inserts will be connected to the profile by a simple click-in mechanism, which offers a high degree of flexibility without using any tools. To meet the requirements of professional lighting task, the fixed Spots can be selected with on/off as well as with DALI drivers.

Les spots fixes simples puissants et non éblouissants d'un diamètre de 72 mm pour la basse tension modulaire LINE48V offrent de nombreuses possibilités de configuration. La température de couleur est disponible en 2700K, 3000K et 4000K et peut être adaptée à vos besoins avec un indice de rendu des couleurs >90. Du fait que la LED est installée profondément dans le boîtier, les LINE48V Fixed Spot Inserts offrent un confort visuel élevé et un éclairage sans éblouissement avec une valeur UGR <19. De plus, cinq réflecteurs de couleurs différentes peuvent être choisis librement par modèle afin de créer l'élément de design parfait pour une ambiance atmosphérique. Les modules d'éclairage seront connectés au profilé par un simple mécanisme d'encliquetage, ce qui offre un haut degré de flexibilité sans l'utilisation d'outils. Pour répondre aux exigences d'un éclairage professionnel, les Spots fixes peuvent être sélectionnés avec des pilotes on/off ou DALI.

ÜBERSICHT | OVERVIEW | VUE D'ENSEMBLE

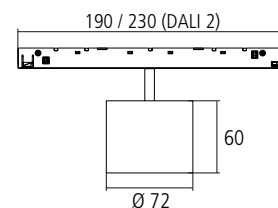

HOUSING COLOUR	
schwarz black noir RAL 9005	
weiß white blanc RAL 9016	

REFLECTOR COLOUR	
specular 648DR-S	white 648DR-W
black 648DR-B	gold 648DR-G
chrome black 648DR-C	

DESIGN
HIGHLIGHT
DETAIL



dimmable	spot type	Colour	dimensions [mm]	colour temp. [K]	luminous flux [lm]	weight [kg]	material number
not dimmable							
	■ black [RAL 9005]	■ specular	Ø 72 / L 190 / H 105	2700	735	0,45	648DS-509271-OOBLS
		■ black	Ø 72 / L 190 / H 105	2700	697	0,45	648DS-509271-OOBLB
		■ chrome black	Ø 72 / L 190 / H 105	2700	707	0,45	648DS-509271-OOBLC
		□ white	Ø 72 / L 190 / H 105	2700	728	0,45	648DS-509271-OOBLW
		■ gold	Ø 72 / L 190 / H 105	2700	730	0,45	648DS-509271-OOBLG
	□ white [RAL 9016]	■ specular	Ø 72 / L 190 / H 105	2700	735	0,45	648DS-509271-OOWHS
		■ black	Ø 72 / L 190 / H 105	2700	697	0,45	648DS-509271-OOWHB
		■ chrome black	Ø 72 / L 190 / H 105	2700	707	0,45	648DS-509271-OOWHC
		□ white	Ø 72 / L 190 / H 105	2700	728	0,45	648DS-509271-OOWHW
		■ gold	Ø 72 / L 190 / H 105	2700	730	0,45	648DS-509271-OOWHG
	■ black [RAL 9005]	■ specular	Ø 72 / L 190 / H 105	3000	782	0,45	648DS-509301-OOBLS
		■ black	Ø 72 / L 190 / H 105	3000	741	0,45	648DS-509301-OOBLB
		■ chrome black	Ø 72 / L 190 / H 105	3000	752	0,45	648DS-509301-OOBLC
		□ white	Ø 72 / L 190 / H 105	3000	774	0,45	648DS-509301-OOBLW
		■ gold	Ø 72 / L 190 / H 105	3000	777	0,45	648DS-509301-OOBLG
	□ white [RAL 9016]	■ specular	Ø 72 / L 190 / H 105	3000	782	0,45	648DS-509301-OOWHS
		■ black	Ø 72 / L 190 / H 105	3000	741	0,45	648DS-509301-OOWHB
		■ chrome black	Ø 72 / L 190 / H 105	3000	752	0,45	648DS-509301-OOWHC
		□ white	Ø 72 / L 190 / H 105	3000	774	0,45	648DS-509301-OOWHW
		■ gold	Ø 72 / L 190 / H 105	3000	777	0,45	648DS-509301-OOWHG
■ black [RAL 9005]	■ specular	Ø 72 / L 190 / H 105	4000	845	0,45	648DS-509401-OOBLS	
	■ black	Ø 72 / L 190 / H 105	4000	801	0,45	648DS-509401-OOBLB	
	■ chrome black	Ø 72 / L 190 / H 105	4000	813	0,45	648DS-509401-OOBLC	
	□ white	Ø 72 / L 190 / H 105	4000	837	0,45	648DS-509401-OOBLW	
	■ gold	Ø 72 / L 190 / H 105	4000	840	0,45	648DS-509401-OOBLG	
□ white [RAL 9016]	■ specular	Ø 72 / L 190 / H 105	4000	845	0,45	648DS-509401-OOWHS	
	■ black	Ø 72 / L 190 / H 105	4000	801	0,45	648DS-509401-OOWHB	
	■ chrome black	Ø 72 / L 190 / H 105	4000	813	0,45	648DS-509401-OOWHC	
	□ white	Ø 72 / L 190 / H 105	4000	837	0,45	648DS-509401-OOWHW	
	■ gold	Ø 72 / L 190 / H 105	4000	840	0,45	648DS-509401-OOWHG	

LINE48V

FIXED SPOT | FIXED SPOT | *FIXED SPOT*



dimnable	spot type	colour	dimensions [mm]	colour temp. [K]	luminous flux [lm]	weight [kg]	material number
dimnable dali 2							
	■ black [RAL 9005]	■ specular	Ø 72 / L 230 / H 105	2700	735	0,46	648DS-509271-DDBLS
		■ black	Ø 72 / L 230 / H 105	2700	697	0,46	648DS-509271-DDBLB
		■ chrome black	Ø 72 / L 230 / H 105	2700	707	0,46	648DS-509271-DDBLC
		□ white	Ø 72 / L 230 / H 105	2700	728	0,46	648DS-509271-DDBLW
		■ gold	Ø 72 / L 230 / H 105	2700	730	0,46	648DS-509271-DDBLG
	□ white [RAL 9016]	■ specular	Ø 72 / L 230 / H 105	2700	735	0,46	648DS-509271-DDWHS
		■ black	Ø 72 / L 230 / H 105	2700	697	0,46	648DS-509271-DDWHB
		■ chrome black	Ø 72 / L 230 / H 105	2700	707	0,46	648DS-509271-DDWHC
		□ white	Ø 72 / L 230 / H 105	2700	728	0,46	648DS-509271-DDWHW
		■ gold	Ø 72 / L 230 / H 105	2700	730	0,46	648DS-509271-DDWHG
	■ black [RAL 9005]	■ specular	Ø 72 / L 230 / H 105	3000	782	0,46	648DS-509301-DDBLS
		■ black	Ø 72 / L 230 / H 105	3000	741	0,46	648DS-509301-DDBLB
		■ chrome black	Ø 72 / L 230 / H 105	3000	752	0,46	648DS-509301-DDBLC
		□ white	Ø 72 / L 230 / H 105	3000	774	0,46	648DS-509301-DDBLW
		■ gold	Ø 72 / L 230 / H 105	3000	777	0,46	648DS-509301-DDBLG
	□ white [RAL 9016]	■ specular	Ø 72 / L 230 / H 105	3000	782	0,46	648DS-509301-DDWHS
		■ black	Ø 72 / L 230 / H 105	3000	741	0,46	648DS-509301-DDWHB
		■ chrome black	Ø 72 / L 230 / H 105	3000	752	0,46	648DS-509301-DDWHC
		□ white	Ø 72 / L 230 / H 105	3000	774	0,46	648DS-509301-DDWHW
		■ gold	Ø 72 / L 230 / H 105	3000	777	0,46	648DS-509301-DDWHG
	■ black [RAL 9005]	■ specular	Ø 72 / L 230 / H 105	4000	845	0,46	648DS-509401-DDBLS
		■ black	Ø 72 / L 230 / H 105	4000	801	0,46	648DS-509401-DDBLB
		■ chrome black	Ø 72 / L 230 / H 105	4000	813	0,46	648DS-509401-DDBLC
		□ white	Ø 72 / L 230 / H 105	4000	837	0,46	648DS-509401-DDBLW
		■ gold	Ø 72 / L 230 / H 105	4000	840	0,46	648DS-509401-DDBLG
	□ white [RAL 9016]	■ specular	Ø 72 / L 230 / H 105	4000	845	0,46	648DS-509401-DDWHS
		■ black	Ø 72 / L 230 / H 105	4000	801	0,46	648DS-509401-DDWHB
		■ chrome black	Ø 72 / L 230 / H 105	4000	813	0,46	648DS-509401-DDWHC
		□ white	Ø 72 / L 230 / H 105	4000	837	0,46	648DS-509401-DDWHW
		■ gold	Ø 72 / L 230 / H 105	4000	840	0,46	648DS-509401-DDWHG



LINE48V

FIXED SPOT | FIXED SPOT | FIXED SPOT

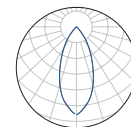

Die leistungsstarken und blendfreien Doppel Fixed Spots mit Ø 72 mm Durchmesser für das modulare LINE48V Niedervolt-System versprechen eine Vielzahl von unterschiedlichen Konfigurationsmöglichkeiten. Die Farbtemperatur ist in 2700K, 3000K und 4000K erhältlich und kann mit einem Farbwiedergabeindex >90 an Ihre Anforderungen angepasst werden. Durch den tiefen Einbau der LED in das Gehäuse bieten die LINE48V Fixed Spot Einsätze einen hohen Sehkomfort und eine blendfreie Ausleuchtung mit einem UGR-Wert <19. Darüber hinaus können pro Modell fünf verschiedenfarbige Reflektoren frei gewählt werden, um das perfekte Gestaltungselement für ein stimmungsvolles Ambiente zu schaffen. Die Lichteinsätze werden durch einen einfachen Einrastmechanismus mit dem Profil verbunden, der ein hohes Maß an Flexibilität ohne den Einsatz von Werkzeug bietet. Um den Anforderungen professioneller Beleuchtungsaufgaben gerecht zu werden, können die festen Spots sowohl mit on/off- als auch mit DALI-Treibern gewählt werden.

The powerful and glare-free Double Fixed Spots with Ø 72 mm diameter for the modular LINE48V Low Voltage promises a variety of different configurations options. The color temperature is available in 2700K, 3000K and 4000K and can be adapted to your requirements with a color rendering index >90. Due to the fact that the LED is installed deep in the housing, the LINE48V Fixed Spot Inserts offer a high visual comfort and a glare-free illumination with a UGR value <19. Furthermore, five different colored reflectors can be freely selected per model to create the perfect design element for an atmospheric ambience. The light inserts will be connected to the profile by a simple click-in mechanism, which offers a high degree of flexibility without using any tools. To meet the requirements of professional lighting task, the fixed Spots can be selected with on/off as well as with DALI drivers.

Les spots fixes doubles puissants et non éblouissants d'un diamètre de 72 mm pour la basse tension modulaire LINE48V offrent de nombreuses possibilités de configuration. La température de couleur est disponible en 2700K, 3000K et 4000K et peut être adaptée à vos besoins avec un indice de rendu des couleurs >90. Du fait que la LED est installée profondément dans le boîtier, les LINE48V Fixed Spot Inserts offrent un confort visuel élevé et un éclairage sans éblouissement avec une valeur UGR <19. De plus, cinq réflecteurs de couleurs différentes peuvent être choisis librement par modèle afin de créer l'élément de design parfait pour une ambiance atmosphérique. Les modules d'éclairage seront connectés au profilé par un simple mécanisme d'encliquetage, ce qui offre un haut degré de flexibilité sans l'utilisation d'outils. Pour répondre aux exigences d'un éclairage professionnel, les Spots fixes peuvent être sélectionnés avec des pilotes on/off ou DALI.

ÜBERSICHT | OVERVIEW | VUE D'ENSEMBLE



2 x 10 W

50°

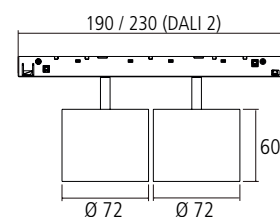

HOUSING COLOUR

schwarz | black | noir
RAL 9005



weiß | white | blanc
RAL 9016



REFLECTOR COLOUR

specular 648DR-S



white 648DR-W



black 648DR-B



gold 648DR-G



chrome black 648DR-C





dimmable	spot type	colour	dimensions [mm]	colour temp. [K]	luminous flux [lm]	weight [kg]	material number
not dimmable							
	■ black [RAL 9005]	■ specular	Ø 72 / L 190 / H 105	2700	2 x 736	0,68	648DD-509271-OOBLS
		■ black	Ø 72 / L 190 / H 105	2700	2 x 697	0,68	648DD-509271-OOBLB
		■ chrome black	Ø 72 / L 190 / H 105	2700	2 x 707	0,68	648DD-509271-OOBLC
		□ white	Ø 72 / L 190 / H 105	2700	2 x 728	0,68	648DD-509271-OOBLW
		■ gold	Ø 72 / L 190 / H 105	2700	2 x 730	0,68	648DD-509271-OOBLG
	□ white [RAL 9016]	■ specular	Ø 72 / L 190 / H 105	2700	2 x 736	0,68	648DD-509271-OOWHS
		■ black	Ø 72 / L 190 / H 105	2700	2 x 697	0,68	648DD-509271-OOWHB
		■ chrome black	Ø 72 / L 190 / H 105	2700	2 x 707	0,68	648DD-509271-OOWHC
		□ white	Ø 72 / L 190 / H 105	2700	2 x 728	0,68	648DD-509271-OOWHW
		■ gold	Ø 72 / L 190 / H 105	2700	2 x 730	0,68	648DD-509271-OOWHG
	■ black [RAL 9005]	■ specular	Ø 72 / L 190 / H 105	3000	2 x 782	0,68	648DD-509301-OOBLS
		■ black	Ø 72 / L 190 / H 105	3000	2 x 741	0,68	648DD-509301-OOBLB
		■ chrome black	Ø 72 / L 190 / H 105	3000	2 x 752	0,68	648DD-509301-OOBLC
		□ white	Ø 72 / L 190 / H 105	3000	2 x 774	0,68	648DD-509301-OOBLW
		■ gold	Ø 72 / L 190 / H 105	3000	2 x 777	0,68	648DD-509301-OOBLG
	□ white [RAL 9016]	■ specular	Ø 72 / L 190 / H 105	3000	2 x 782	0,68	648DD-509301-OOWHS
		■ black	Ø 72 / L 190 / H 105	3000	2 x 741	0,68	648DD-509301-OOWHB
		■ chrome black	Ø 72 / L 190 / H 105	3000	2 x 752	0,68	648DD-509301-OOWHC
		□ white	Ø 72 / L 190 / H 105	3000	2 x 774	0,68	648DD-509301-OOWHW
		■ gold	Ø 72 / L 190 / H 105	3000	2 x 777	0,68	648DD-509301-OOWHG
■ black [RAL 9005]	■ specular	Ø 72 / L 190 / H 105	4000	2 x 845	0,68	648DD-509401-OOBLS	
	■ black	Ø 72 / L 190 / H 105	4000	2 x 801	0,68	648DD-509401-OOBLB	
	■ chrome black	Ø 72 / L 190 / H 105	4000	2 x 813	0,68	648DD-509401-OOBLC	
	□ white	Ø 72 / L 190 / H 105	4000	2 x 837	0,68	648DD-509401-OOBLW	
	■ gold	Ø 72 / L 190 / H 105	4000	2 x 840	0,68	648DD-509401-OOBLG	
□ white [RAL 9016]	■ specular	Ø 72 / L 190 / H 105	4000	2 x 845	0,68	648DD-509401-OOWHS	
	■ black	Ø 72 / L 190 / H 105	4000	2 x 801	0,68	648DD-509401-OOWHB	
	■ chrome black	Ø 72 / L 190 / H 105	4000	2 x 813	0,68	648DD-509401-OOWHC	
	□ white	Ø 72 / L 190 / H 105	4000	2 x 837	0,68	648DD-509401-OOWHW	
	■ gold	Ø 72 / L 190 / H 105	4000	2 x 840	0,68	648DD-509401-OOWHG	

LINE48V

FIXED SPOT | FIXED SPOT | FIXED SPOT



dimnable	spot type	colour	dimensions [mm]	colour temp. [K]	luminous flux [lm]	weight [kg]	material number
dimnable dali 2							
	■ black [RAL 9005]	■ specular	Ø 72 / L 230 / H 105	2700	2 x 736	0,68	648DD-509271-DBBLS
		■ black	Ø 72 / L 230 / H 105	2700	2 x 697	0,68	648DD-509271-DBBLB
		■ chrome black	Ø 72 / L 230 / H 105	2700	2 x 707	0,68	648DD-509271-DBBLC
		□ white	Ø 72 / L 230 / H 105	2700	2 x 728	0,68	648DD-509271-DBBLW
		■ gold	Ø 72 / L 230 / H 105	2700	2 x 730	0,68	648DD-509271-DBBLG
	□ white [RAL 9016]	■ specular	Ø 72 / L 230 / H 105	2700	2 x 736	0,68	648DD-509271-DDWHS
		■ black	Ø 72 / L 230 / H 105	2700	2 x 697	0,68	648DD-509271-DDWHB
		■ chrome black	Ø 72 / L 230 / H 105	2700	2 x 707	0,68	648DD-509271-DDWHC
		□ white	Ø 72 / L 230 / H 105	2700	2 x 728	0,68	648DD-509271-DDWHW
		■ gold	Ø 72 / L 230 / H 105	2700	2 x 730	0,68	648DD-509271-DDWHG
■ black [RAL 9005]	■ specular	Ø 72 / L 230 / H 105	3000	2 x 782	0,68	648DD-509301-DBBLS	
	■ black	Ø 72 / L 230 / H 105	3000	2 x 741	0,68	648DD-509301-DBBLB	
	■ chrome black	Ø 72 / L 230 / H 105	3000	2 x 752	0,68	648DD-509301-DBBLC	
	□ white	Ø 72 / L 230 / H 105	3000	2 x 774	0,68	648DD-509301-DBBLW	
	■ gold	Ø 72 / L 230 / H 105	3000	2 x 777	0,68	648DD-509301-DBBLG	
	□ white [RAL 9016]	■ specular	Ø 72 / L 230 / H 105	3000	2 x 782	0,68	648DD-509301-DDWHS
		■ black	Ø 72 / L 230 / H 105	3000	2 x 741	0,68	648DD-509301-DDWHB
		■ chrome black	Ø 72 / L 230 / H 105	3000	2 x 752	0,68	648DD-509301-DDWHC
		□ white	Ø 72 / L 230 / H 105	3000	2 x 774	0,68	648DD-509301-DDWHW
		■ gold	Ø 72 / L 230 / H 105	3000	2 x 777	0,68	648DD-509301-DDWHG
■ black [RAL 9005]	■ specular	Ø 72 / L 230 / H 105	4000	2 x 845	0,68	648DD-509401-DBBLS	
	■ black	Ø 72 / L 230 / H 105	4000	2 x 801	0,68	648DD-509401-DBBLB	
	■ chrome black	Ø 72 / L 230 / H 105	4000	2 x 813	0,68	648DD-509401-DBBLC	
	□ white	Ø 72 / L 230 / H 105	4000	2 x 837	0,68	648DD-509401-DBBLW	
	■ gold	Ø 72 / L 230 / H 105	4000	2 x 840	0,68	648DD-509401-DBBLG	
□ white [RAL 9016]	■ specular	Ø 72 / L 230 / H 105	4000	2 x 845	0,68	648DD-509401-DDWHS	
	■ black	Ø 72 / L 230 / H 105	4000	2 x 801	0,68	648DD-509401-DDWHB	
	■ chrome black	Ø 72 / L 230 / H 105	4000	2 x 813	0,68	648DD-509401-DDWHC	
	□ white	Ø 72 / L 230 / H 105	4000	2 x 837	0,68	648DD-509401-DDWHW	
	■ gold	Ø 72 / L 230 / H 105	4000	2 x 840	0,68	648DD-509401-DDWHG	

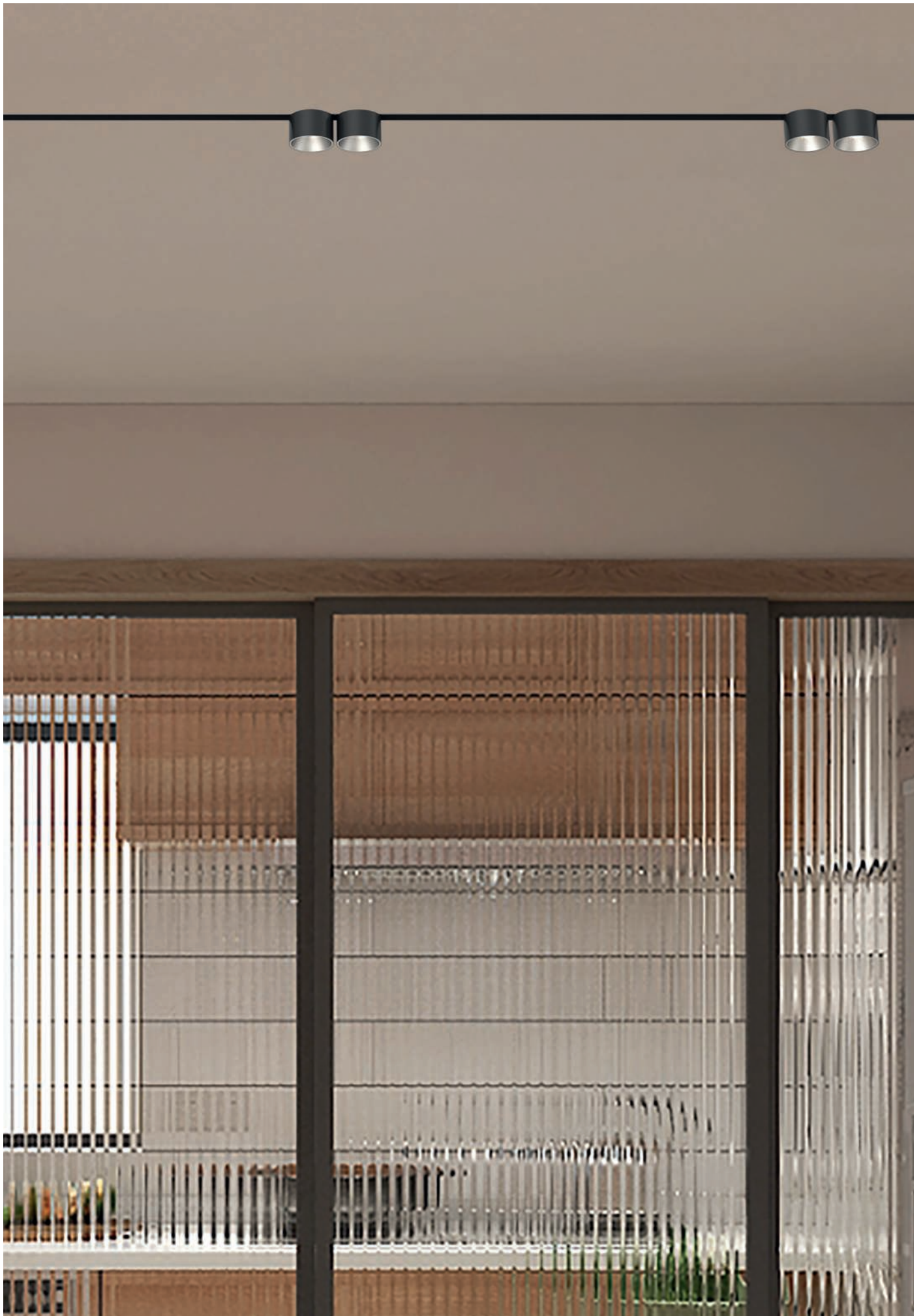

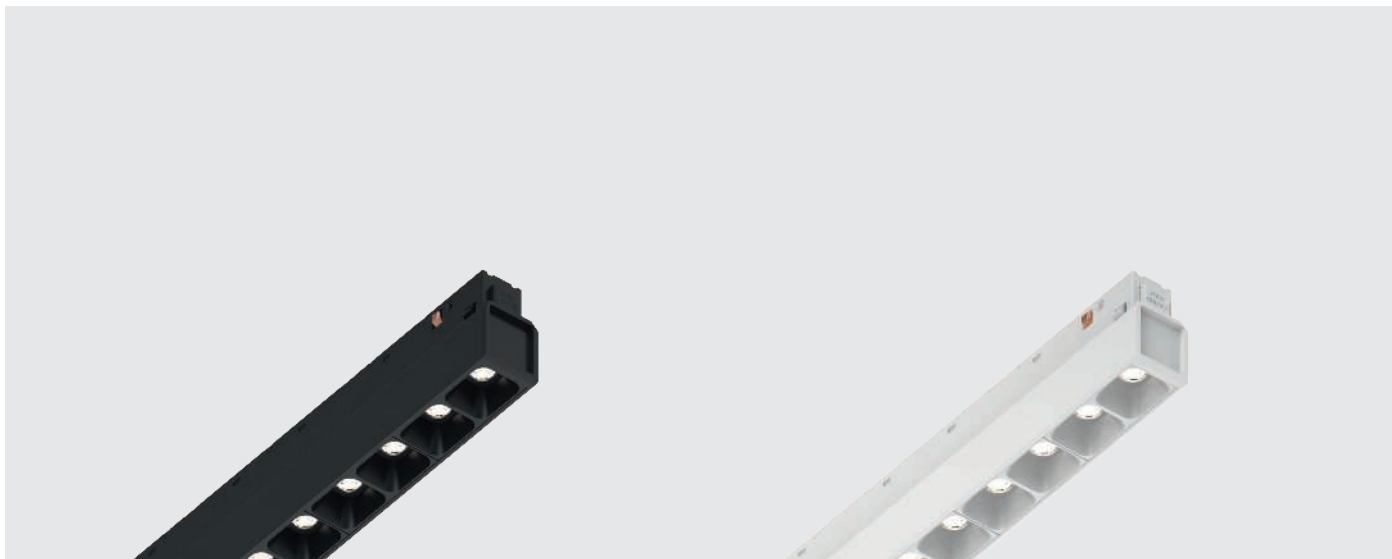
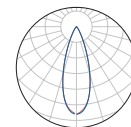

Das leistungsstarke Linsenmodul für das modulare LINE48V Niedervolt-System verspricht eine Vielzahl von unterschiedlichen Konfigurationsmöglichkeiten. Die Farbtemperatur ist in 2700K, 3000K und 4000K erhältlich und kann mit einem Farbwiedergabeindex >90 an Ihre Anforderungen angepasst werden. Durch den tiefen Einbau der LED in das Gehäuse bietet die LINE48V Lens Module einen hohen Sehkomfort mit einem UGR-Wert <16. Die Lichteinsätze werden durch einen einfachen Klick-Mechanismus mit dem Profil verbunden, was ein hohes Maß an Flexibilität ohne den Einsatz von Werkzeug bietet. Um den Anforderungen professioneller Beleuchtungsaufgaben gerecht zu werden, kann das Linsenmodul sowohl mit on/off- als auch mit DALI-Treibern ausgewählt werden.

The powerful Lens Module for the modular LINE48V Low Voltage System promises a variety of different configurations options. The colour temperature is available in 2700K, 3000K and 4000K and can be adapted to your requirements with a colour rendering index >90. Due to the fact that the LED is installed deep in the housing, the LINE48V Accent Light LM offers a high visual comfort and a glare-free illumination with a UGR value <16. The light inserts will be connected to the profile by a simple click-in mechanism, which offers a high degree of flexibility without using any tools. To meet the requirements of professional lighting task, the Accent Light can be selected with on/off as well as with DALI drivers.

Le puissant module de lentille pour le système modulaire à basse tension LINE48V offre une grande variété d'options de configuration. La température de couleur est disponible en 2700K, 3000K et 4000K et peut être adaptée à vos besoins avec un indice de rendu des couleurs >90. Du fait que la LED est installée profondément dans le boîtier, la LINE48V Accent Light LM offre un confort visuel élevé et un éclairage sans éblouissement avec une valeur UGR <16. Les inserts lumineux seront connectés au profilé par un simple mécanisme d'encliquetage, ce qui offre un haut degré de flexibilité sans l'utilisation d'outils. Pour répondre aux exigences d'un éclairage professionnel, l'Accent Light peut être sélectionné avec des pilotes on/off ou DALI.

ÜBERSICHT | OVERVIEW | VUE D'ENSEMBLE

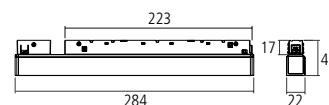

dimmable	colour	dimensions [mm]	colour temp. [K]	luminous flux [lm]	weight [kg]	material number
	■ black [RAL 9005]	L 284 / W 22 / H 43	2700	1131	0,2	648LM-029271-OOBLB
	□ white [RAL 9016]	L 284 / W 22 / H 43	2700	1131	0,2	648LM-029271-OOWHW
	■ black [RAL 9005]	L 284 / W 22 / H 43	3000	1202	0,2	648LM-029301-OOBLB
	□ white [RAL 9016]	L 284 / W 22 / H 43	3000	1202	0,2	648LM-029301-OOWHW
	■ black [RAL 9005]	L 284 / W 22 / H 43	4000	1360	0,2	648LM-029401-OOBLB
	□ white [RAL 9016]	L 284 / W 22 / H 43	4000	1360	0,2	648LM-029401-OOWHW
DALI 2	■ black [RAL 9005]	L 284 / W 22 / H 43	2700	1131	0,2	648LM-029271-DDBLB
	□ white [RAL 9016]	L 284 / W 22 / H 43	2700	1131	0,2	648LM-029271-DDWHW
	■ black [RAL 9005]	L 284 / W 22 / H 43	3000	1202	0,2	648LM-029301-DDBLB
	□ white [RAL 9016]	L 284 / W 22 / H 43	3000	1202	0,2	648LM-029301-DDWHW
	■ black [RAL 9005]	L 284 / W 22 / H 43	4000	1360	0,2	648LM-029401-DDBLB
	□ white [RAL 9016]	L 284 / W 22 / H 43	4000	1360	0,2	648LM-029401-DDWHW

LINE48V

OPAL MODULE | OPAL MODULE | OPAL MODULE

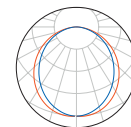

Das LINE48V Opal Modul ist in zwei verschiedenen Längen für das module LINE48V Niedervolt-System erhältlich, um einen nahtlosen Übergang der Allgemeinbeleuchtung zu gewährleisten. Von einer Länge der Allgemeinbeleuchtung von 560 mm mit 13 W, bis zu einer Länge von 1120 mm mit 26 W können homogene Beleuchtungslösungen für unterschiedlichste Planungssituationen geschaffen werden. Die Farbtemperatur ist in 2700K, 3000K und 4000K erhältlich und kann mit einem Farbwiedergabeindex >90 an Ihre Anforderungen angepasst werden. Die Lichteinsätze werden durch einen einfachen Einrastmechanismus mit dem Profil verbunden, was ein hohes Maß an Flexibilität ohne den Einsatz von Werkzeugen bietet. Um den Anforderungen professioneller Beleuchtungsaufgaben gerecht zu werden, kann das Opal Modul sowohl mit on/off- als auch mit DALI-Treibern gewählt werden.

The LINE48V Opal Module is available in two different lengths for the LINE48V Low Voltage system to ensure a seamless transition of general lighting. From a length of the General Light of 560 mm with 13 W to a length of 1120 mm with 26 W, homogenous lighting solutions can be created for a wide range of planning situations. The color temperature is available in 2700K, 3000K and 4000K and can be adapted to your requirements with a color rendering index >90. The light inserts will be connected to the profile by a simple click-in mechanism, which offers a high degree of flexibility without using any tools. To meet the requirements of professional lighting task, the Opal Module can be selected with on/off as well as with DALI drivers.

Le module opale LINE48V est disponible en deux longueurs différentes pour le système basse tension LINE48V afin d'assurer une transition transparente de l'éclairage général. D'une longueur de 560 mm avec 13 W à une longueur de 1120 mm avec 26 W, des solutions d'éclairage homogènes peuvent être créées pour un large éventail de situations de planification. La température de couleur est disponible en 2700K, 3000K et 4000K et peut être adaptée à vos besoins avec un indice de rendu des couleurs >90. Les modules d'éclairage sont reliés au profilé par un simple mécanisme d'encliquetage, ce qui offre une grande flexibilité sans l'utilisation d'outils. Pour répondre aux exigences d'un éclairage professionnel, le module Opal peut être sélectionné avec des pilotes on/off ou DALI.

ÜBERSICHT | OVERVIEW | VUE D'ENSEMBLE



dimmable	colour	dimensions [mm]	colour temp. [K]	luminous flux [lm]	power [W]	weight [kg]	material number
✖	■ black [RAL 9005]	L 560 / W 22 / H 43	2700	798	13	0,56	648OM-059271-OOBLO
	□ white [RAL 9016]	L 560 / W 22 / H 43	2700	798	13	0,56	648OM-059271-OOWHO
	■ black [RAL 9005]	L 560 / W 22 / H 43	3000	849	13	0,56	648OM-059301-OOBLO
	□ white [RAL 9016]	L 560 / W 22 / H 43	3000	849	13	0,56	648OM-059301-OOWHO
	■ black [RAL 9005]	L 560 / W 22 / H 43	4000	890	13	0,56	648OM-059401-OOBLO
	□ white [RAL 9016]	L 560 / W 22 / H 43	4000	890	13	0,56	648OM-059401-OOWHO
	■ black [RAL 9005]	L 1120 / W 22 / H 43	2700	1513	26	0,96	648OM-119271-OOBLO
	□ white [RAL 9016]	L 1120 / W 22 / H 43	2700	1513	26	0,96	648OM-119271-OOWHO
	■ black [RAL 9005]	L 1120 / W 22 / H 43	3000	1609	26	0,96	648OM-119301-OOBLO
	□ white [RAL 9016]	L 1120 / W 22 / H 43	3000	1609	26	0,96	648OM-119301-OOWHO
	■ black [RAL 9005]	L 1120 / W 22 / H 43	4000	1704	26	0,96	648OM-119401-OOBLO
	□ white [RAL 9016]	L 1120 / W 22 / H 43	4000	1704	26	0,96	648OM-119401-OOWHO
☑	■ black [RAL 9005]	L 560 / W 22 / H 43	2700	798	13	0,56	648OM-059271-DOBLO
	□ white [RAL 9016]	L 560 / W 22 / H 43	2700	798	13	0,56	648OM-059271-DOWHO
	■ black [RAL 9005]	L 560 / W 22 / H 43	3000	849	13	0,56	648OM-059301-DOBLO
	□ white [RAL 9016]	L 560 / W 22 / H 43	3000	849	13	0,56	648OM-059301-DOWHO
	■ black [RAL 9005]	L 560 / W 22 / H 43	4000	890	13	0,56	648OM-059401-DOBLO
	□ white [RAL 9016]	L 560 / W 22 / H 43	4000	890	13	0,56	648OM-059401-DOWHO
	■ black [RAL 9005]	L 1120 / W 22 / H 43	2700	1513	26	0,96	648OM-119271-DOBLO
	□ white [RAL 9016]	L 1120 / W 22 / H 43	2700	1513	26	0,96	648OM-119271-DOWHO
	■ black [RAL 9005]	L 1120 / W 22 / H 43	3000	1609	26	0,96	648OM-119301-DOBLO
	□ white [RAL 9016]	L 1120 / W 22 / H 43	3000	1609	26	0,96	648OM-119301-DOWHO
	■ black [RAL 9005]	L 1120 / W 22 / H 43	4000	1704	26	0,96	648OM-119401-DOBLO
	□ white [RAL 9016]	L 1120 / W 22 / H 43	4000	1704	26	0,96	648OM-119401-DOWHO

LINE48V

PRISM MODULE | PRISM MODULE | PRISM MODULE

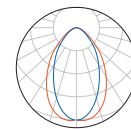

Das LINE48V Prismenmodul ist in der Länge von 1120 mm für das modulare LINE48V Niedervolt-System erhältlich, um einen nahtlosen Übergang der Allgemeinbeleuchtung mit Mikroprismen-Diffusor zu gewährleisten. Die Farbtemperatur ist in 3000K und 4000K erhältlich und kann mit einem Farbwiedergabeindex >90 an Ihre Anforderungen angepasst werden. Die Lichteinsätze werden durch einen einfachen Einrastmechanismus mit dem Profil verbunden, der ein hohes Maß an Flexibilität ohne den Einsatz von Werkzeugen bietet. Um den Anforderungen professioneller Beleuchtungsaufgaben gerecht zu werden, kann das Prismamodul sowohl mit on/off- als auch mit DALI-Treibern gewählt werden

The LINE48V Prism Module is available in the length of 1120 mm for the modular LINE48V Low Voltage system to ensure a seamless transition of general lighting with microprismatic diffuser. The color temperature is available in 3000K and 4000K and can be adapted to your requirements with a color rendering index >90. The light inserts will be connected to the profile by a simple click-in mechanism, which offers a high degree of flexibility without using any tools. To meet the requirements of professional lighting task, the Prism Module can be selected with on/off as well as with DALI drivers.

Le module de prisme LINE48V est disponible en longueur de 1120 mm pour le système modulaire LINE48V basse tension afin d'assurer une transition en douceur de l'éclairage général avec un diffuseur microprismatique. La température de couleur est disponible en 3000K et 4000K et peut être adaptée à vos besoins avec un indice de rendu des couleurs >90. Les inserts d'éclairage sont reliés au profilé par un simple mécanisme d'encliquetage qui offre un haut niveau de flexibilité sans avoir besoin d'utiliser des outils. Pour répondre aux exigences d'éclairage professionnel, le module prisme peut être choisi avec des drivers on/off ou DALI.

ÜBERSICHT | OVERVIEW | VUE D'ENSEMBLE



dimmable	colour	dimensions [mm]	colour temp. [K]	luminous flux [lm]	weight [kg]	material number
	■ black [RAL 9005]	L 1120 / W 22 / H 43	3000	1670	0,96	648MM-119301-OOBLM
	□ white [RAL 9016]	L 1120 / W 22 / H 43	3000	1670	0,96	648MM-119301-OOWHM
	■ black [RAL 9005]	L 1120 / W 22 / H 43	4000	1743	0,96	648MM-119401-OOBLM
	□ white [RAL 9016]	L 1120 / W 22 / H 43	4000	1743	0,96	648MM-119401-OOWHM
	■ black [RAL 9005]	L 1120 / W 22 / H 43	3000	1670	0,96	648MM-119301-DDBLM
	□ white [RAL 9016]	L 1120 / W 22 / H 43	3000	1670	0,96	648MM-119301-DDWHM
	■ black [RAL 9005]	L 1120 / W 22 / H 43	4000	1743	0,96	648MM-119401-DDBLM
	□ white [RAL 9016]	L 1120 / W 22 / H 43	4000	1743	0,96	648MM-119401-DDWHM

LINE48V

WALL WASHER | WALL WASHER | WALL WASHER

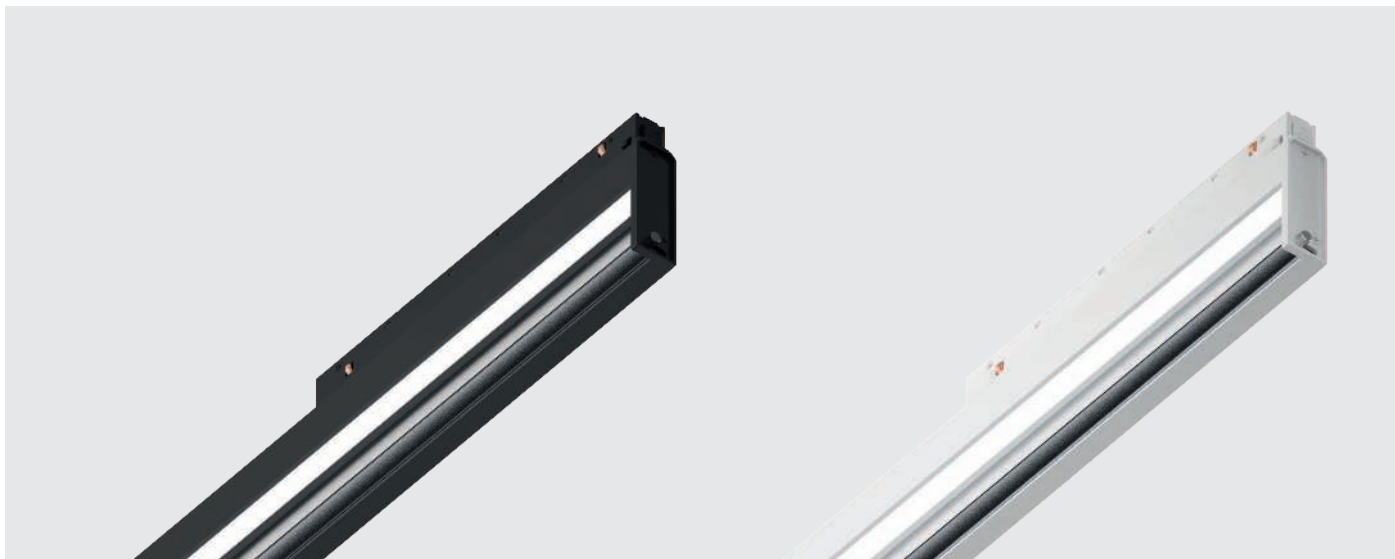
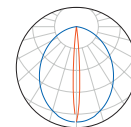

Der LINE48V Wall Washer bietet mit einer Länge von 570 mm viel Flexibilität. Das moderne Design des Wall Washer erlaubt es, den Abstrahlwinkel der Leuchte um bis zu 13° zu verstellen. Die Farbtemperatur ist in 2700K, 3000K und 4000K erhältlich und kann mit einem Farbwiedergabeindex >90 an Ihre Anforderungen angepasst werden. Die Lichteinsätze werden durch einen einfachen Einrastmechanismus mit dem Profil verbunden, der ein hohes Maß an Flexibilität ohne den Einsatz von Werkzeugen bietet. Um den Anforderungen professioneller Beleuchtungsaufgaben gerecht zu werden, kann das Wall Washer sowohl mit on/off- als auch mit DALI-Treibern gewählt werden

The LINE48V Wall Washer provides a lot of flexibility within the length of 570 mm. The modern design of the Wall Washer allows the output angle of the light to be adjusted by up to 13°. The color temperature is available in 2700K, 3000K and 4000K and can be adapted to your requirements with a color rendering index >90. The light inserts will be connected to the profile by a simple click-in mechanism, which offers a high degree of flexibility without using any tools. To meet the requirements of professional lighting task, the Wall Washer can be selected with on/off as well as with DALI drivers.

Le lèche-mur LINE48V offre une grande flexibilité dans une longueur de 570 mm. Le design moderne du lèche-mur permet d'ajuster l'angle de sortie de la lumière jusqu'à 13°. La température de couleur est disponible en 2700K, 3000K et 4000K et peut être adaptée à vos besoins avec un indice de rendu des couleurs >90. Les inserts d'éclairage sont reliés au profilé par un simple mécanisme d'encliquetage qui offre un haut niveau de flexibilité sans avoir besoin d'utiliser des outils. Pour répondre aux exigences d'éclairage professionnel, le lèche-mur peut être choisi avec des drivers on/off ou DALI.

ÜBERSICHT | OVERVIEW | VUE D'ENSEMBLE

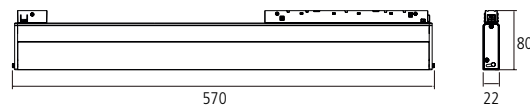

dimmable	colour	dimensions [mm]	colour temp. [K]	luminous flux [lm]	weight [kg]	material number
	■ black [RAL 9005]	L 570 / W 22 / H 80	2700	633	0,7	648AM-059271-OOBLA
	□ white [RAL 9016]	L 570 / W 22 / H 80	2700	633	0,7	648AM-059271-OOWHA
	■ black [RAL 9005]	L 570 / W 22 / H 80	3000	786	0,7	648AM-059301-OOBLA
	□ white [RAL 9016]	L 570 / W 22 / H 80	3000	786	0,7	648AM-059301-OOWHA
	■ black [RAL 9005]	L 570 / W 22 / H 80	4000	801	0,7	648AM-059401-OOBLA
	□ white [RAL 9016]	L 570 / W 22 / H 80	4000	801	0,7	648AM-059401-OOWHA
DALI 2	■ black [RAL 9005]	L 570 / W 22 / H 80	2700	633	0,71	648AM-059271-DDBLA
	□ white [RAL 9016]	L 570 / W 22 / H 80	2700	633	0,71	648AM-059271-DDWHA
	■ black [RAL 9005]	L 570 / W 22 / H 80	3000	786	0,71	648AM-059301-DDBLA
	□ white [RAL 9016]	L 570 / W 22 / H 80	3000	786	0,71	648AM-059301-DDWHA
	■ black [RAL 9005]	L 570 / W 22 / H 80	4000	801	0,71	648AM-059401-DDBLA
	□ white [RAL 9016]	L 570 / W 22 / H 80	4000	801	0,71	648AM-059401-DDWHA

LINE48V

PIEDALE | PIEDALE | PIEDALE

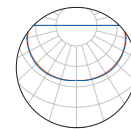

Der dekorative Glaskugeleinsatz für das LINE48V Niedervolt-System bietet ein minimalistisches, elegantes Design. LINE48V Piedale ist mit einer Pendellänge von 2000 mm erhältlich, die durch einen speziellen Mechanismus im Adapter nachträglich leicht gekürzt werden kann. Die Lichteinsätze werden durch einen einfachen Einrastmechanismus mit dem Profil verbunden, der ein hohes Maß an Flexibilität ohne den Einsatz von Werkzeug bietet. Um den Anforderungen professioneller Beleuchtungsaufgaben gerecht zu werden, kann die Piedale sowohl mit on/off- als auch mit DALI-Treibern gewählt werden

The decorative glass ball inset for the LINE48V Low Voltage System offers a minimalist, elegant design. LINE48V Piedale is available with a pendant length of 2000 mm, which can be easily shortened afterwards using the special mechanism in the adapter. The light inserts will be connected to the profile by a simple click-in mechanism, which offers a high degree of flexibility without using any tools. To meet the requirements of professional lighting task, the Piedale can be selected with on/off as well as with DALI drivers.

L'insert décoratif en verre pour le système basse tension LINE48V offre un design minimaliste et élégant. LINE48V Piedale est disponible avec une longueur de suspension de 2000 mm, qui peut être facilement raccourcie par la suite grâce au mécanisme spécial de l'adaptateur. Les modules d'éclairage seront connectés au profilé par un simple mécanisme d'encliquetage, ce qui offre un haut degré de flexibilité sans utiliser d'outils. Pour répondre aux exigences d'un éclairage professionnel, le Piedale peut être choisi avec des drivers on/off ou DALI.



ÜBERSICHT | OVERVIEW | VUE D'ENSEMBLE



dimmable	colour	dimensions [mm]	pendulum length [mm]	colour temp. [K]	luminous flux [lm]	weight [kg]	material number
	■ black [RAL 9005]	Ø 120 / L 190	2000	2700	452	0,38	648PP-019271-OOBLO
	□ white [RAL 9016]	Ø 120 / L 190	2000	2700	452	0,38	648PP-019271-OOWHO
	■ black [RAL 9005]	Ø 120 / L 190	2000	3000	518	0,38	648PP-019301-OOBLO
	□ white [RAL 9016]	Ø 120 / L 190	2000	3000	518	0,38	648PP-019301-OOWHO
	■ black [RAL 9005]	Ø 120 / L 190	2000	4000	551	0,38	648PP-019401-OOBLO
	□ white [RAL 9016]	Ø 120 / L 190	2000	4000	551	0,38	648PP-019401-OOWHO
	■ black [RAL 9005]	Ø 120 / L 230	2000	2700	452	0,38	648PP-019271-DDBLO
	□ white [RAL 9016]	Ø 120 / L 230	2000	2700	452	0,38	648PP-019271-DDWHO
	■ black [RAL 9005]	Ø 120 / L 230	2000	3000	518	0,38	648PP-019301-DDBLO
	□ white [RAL 9016]	Ø 120 / L 230	2000	3000	518	0,38	648PP-019301-DDWHO
	■ black [RAL 9005]	Ø 120 / L 230	2000	4000	551	0,38	648PP-019401-DDBLO
	□ white [RAL 9016]	Ø 120 / L 230	2000	4000	551	0,38	648PP-019401-DDWHO



LINE48V

CANALELLO | CANALELLO | CANALELLO

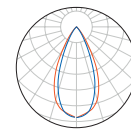

Der dekorative Hängeleuchteneinsatz für das LINE48V Niedervolt-System bietet ein hochwertiges, elegantes Design. LINE48V Canalello ist mit einer Pendellänge von 2000 mm erhältlich, die durch einen speziellen Mechanismus im Adapter nachträglich leicht gekürzt werden kann. Die Lichteinsätze werden durch einen einfachen Einrastmechanismus mit dem Profil verbunden, der ein hohes Maß an Flexibilität ohne den Einsatz von Werkzeug bietet. Um den Anforderungen professioneller Beleuchtungsaufgaben gerecht zu werden, kann die Canalello sowohl mit on/off- als auch mit DALI-Treibern gewählt werden

The decorative pendant inset for the LINE48V Low Voltage System offers a high quality, elegant design. LINE48V Canalello is available with a pendant length of 2000 mm, which can be easily shortened afterwards using the special mechanism in the adapter. The light inserts will be connected to the profile by a simple click-in mechanism, which offers a high degree of flexibility without using any tools. To meet the requirements of professional lighting task, the Canalello can be selected with on/off as well as with DALI drivers.

La suspension décorative pour le système basse tension LINE48V offre un design élégant et de haute qualité. LINE48V Canalello est disponible avec une longueur de suspension de 2000 mm, qui peut être facilement raccourcie par la suite grâce au mécanisme spécial de l'adaptateur. Les modules d'éclairage seront connectés au profilé par un simple mécanisme d'encliquetage, ce qui offre un haut degré de flexibilité sans l'utilisation d'outils. Pour répondre aux exigences d'éclairage professionnel, le module prisme Canalello peut être choisi avec des drivers on/off ou DALI.

ÜBERSICHT | OVERVIEW | VUE D'ENSEMBLE

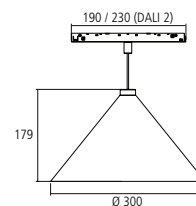

dimmable	colour	dimensions [mm]	pendulum length [mm]	colour temp. [K]	luminous flux [lm]	weight [kg]	material number
	■ black [RAL 9005]	Ø 300 / L 190 / H 179	2000	2700	893	0,6	648PC-039271-OOBLB
	□ white [RAL 9016]	Ø 300 / L 190 / H 179	2000	2700	893	0,6	648PC-039271-OOWHW
	■ black [RAL 9005]	Ø 300 / L 190 / H 179	2000	3000	951	0,6	648PC-039301-OOBLB
	□ white [RAL 9016]	Ø 300 / L 190 / H 179	2000	3000	951	0,6	648PC-039301-OOWHW
	■ black [RAL 9005]	Ø 300 / L 190 / H 179	2000	4000	1163	0,6	648PC-039401-OOBLB
	□ white [RAL 9016]	Ø 300 / L 190 / H 179	2000	4000	1163	0,6	648PC-039401-OOWHW
DALI 2	■ black [RAL 9005]	Ø 300 / L 230 / H 179	2000	2700	893	0,6	648PC-039271-DDBLB
	□ white [RAL 9016]	Ø 300 / L 230 / H 179	2000	2700	893	0,6	648PC-039271-DDWHW
	■ black [RAL 9005]	Ø 300 / L 230 / H 179	2000	3000	951	0,6	648PC-039301-DDBLB
	□ white [RAL 9016]	Ø 300 / L 230 / H 179	2000	3000	951	0,6	648PC-039301-DDWHW
	■ black [RAL 9005]	Ø 300 / L 230 / H 179	2000	4000	1163	0,6	648PC-039401-DDBLB
	□ white [RAL 9016]	Ø 300 / L 230 / H 179	2000	4000	1163	0,6	648PC-039401-DDWHW



LINE48V

TORTORETO | TORTORETO | TORTORETO

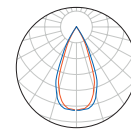

Die minimalistisch gestaltete Pendelleuchte Tortoreto für das LINE48V Niedervolt-System sorgt für eine hervorragende Akzentbeleuchtung mit bester Lichtqualität. Mit einem Durchmesser von Ø 40 mm können unterschiedliche Formen und Größen von wechselnden Objekten ins rechte Licht gerückt werden. Die tief sitzende LED im Inneren der Pendelleuchte sorgt für einen hohen Sehkomfort mit einem UGR-Wert von <19. Die Lichteinsätze werden durch einen einfachen Einrastmechanismus mit dem Profil verbunden, was ein hohes Maß an Flexibilität ohne den Einsatz von Werkzeug bietet. Um den Anforderungen professioneller Beleuchtungsaufgaben gerecht zu werden, kann die Tortoreto sowohl mit on/off- als auch mit DALI-Treibern gewählt werden.

The minimalist designed pendant Tortoreto for LINE48V ensure excellent accent lighting with the best light quality. With a diameter of Ø 40 mm, different shapes and sizes of changing objects can be put into the right light. The low-seat LED inside the pendant lamp provides a high level of visual comfort with a UGR value of <19. The light inserts will be connected to the profile by a simple click-in mechanism, which offers a high degree of flexibility without using any tools. To meet the requirements of professional lighting task, the Tortoreto can be selected with on/off as well as with DALI drivers.

La suspension Tortoreto pour LINE48V, au design minimaliste, assure un excellent éclairage d'accentuation avec une qualité de lumière optimale. Avec un diamètre de 40 mm, les objets changeants de formes et de tailles différentes peuvent être placés dans la bonne lumière. La LED à assise basse à l'intérieur de la lampe suspendue offre un niveau élevé de confort visuel avec une valeur UGR de <19. Les modules d'éclairage seront connectés au profilé par un simple mécanisme d'encliquetage, ce qui offre un haut degré de flexibilité sans l'utilisation d'outils. Pour répondre aux exigences d'éclairage professionnel, le Tortoreto peut être choisi avec des drivers on/off ou DALI.

ÜBERSICHT | OVERVIEW | VUE D'ENSEMBLE

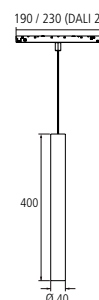

dimmable	colour	dimensions [mm]	pendulum length [mm]	colour temp. [K]	luminous flux [lm]	weight [kg]	material number
	■ black [RAL 9005]	Ø 40 / L 190 / H 400	2000	2700	539	0,65	648PT-309271-OOBLB
	□ white [RAL 9016]	Ø 40 / L 190 / H 400	2000	2700	539	0,65	648PT-309271-OOWHW
	■ black [RAL 9005]	Ø 40 / L 190 / H 400	2000	3000	573	0,65	648PT-309301-OOBLB
	□ white [RAL 9016]	Ø 40 / L 190 / H 400	2000	3000	573	0,65	648PT-309301-OOWHW
	■ black [RAL 9005]	Ø 40 / L 190 / H 400	2000	4000	642	0,65	648PT-309401-OOBLB
	□ white [RAL 9016]	Ø 40 / L 190 / H 400	2000	4000	642	0,65	648PT-309401-OOWHW
DALI 2	■ black [RAL 9005]	Ø 40 / L 230 / H 400	2000	2700	539	0,65	648PT-309271-DDBLB
	□ white [RAL 9016]	Ø 40 / L 230 / H 400	2000	2700	539	0,65	648PT-309271-DDWHW
	■ black [RAL 9005]	Ø 40 / L 230 / H 400	2000	3000	573	0,65	648PT-309301-DDBLB
	□ white [RAL 9016]	Ø 40 / L 230 / H 400	2000	3000	573	0,65	648PT-309301-DDWHW
	■ black [RAL 9005]	Ø 40 / L 230 / H 400	2000	4000	642	0,65	648PT-309401-DDBLB
	□ white [RAL 9016]	Ø 40 / L 230 / H 400	2000	4000	642	0,65	648PT-309401-DDWHW

LINE48V

ROBE | ROBE | ROBE

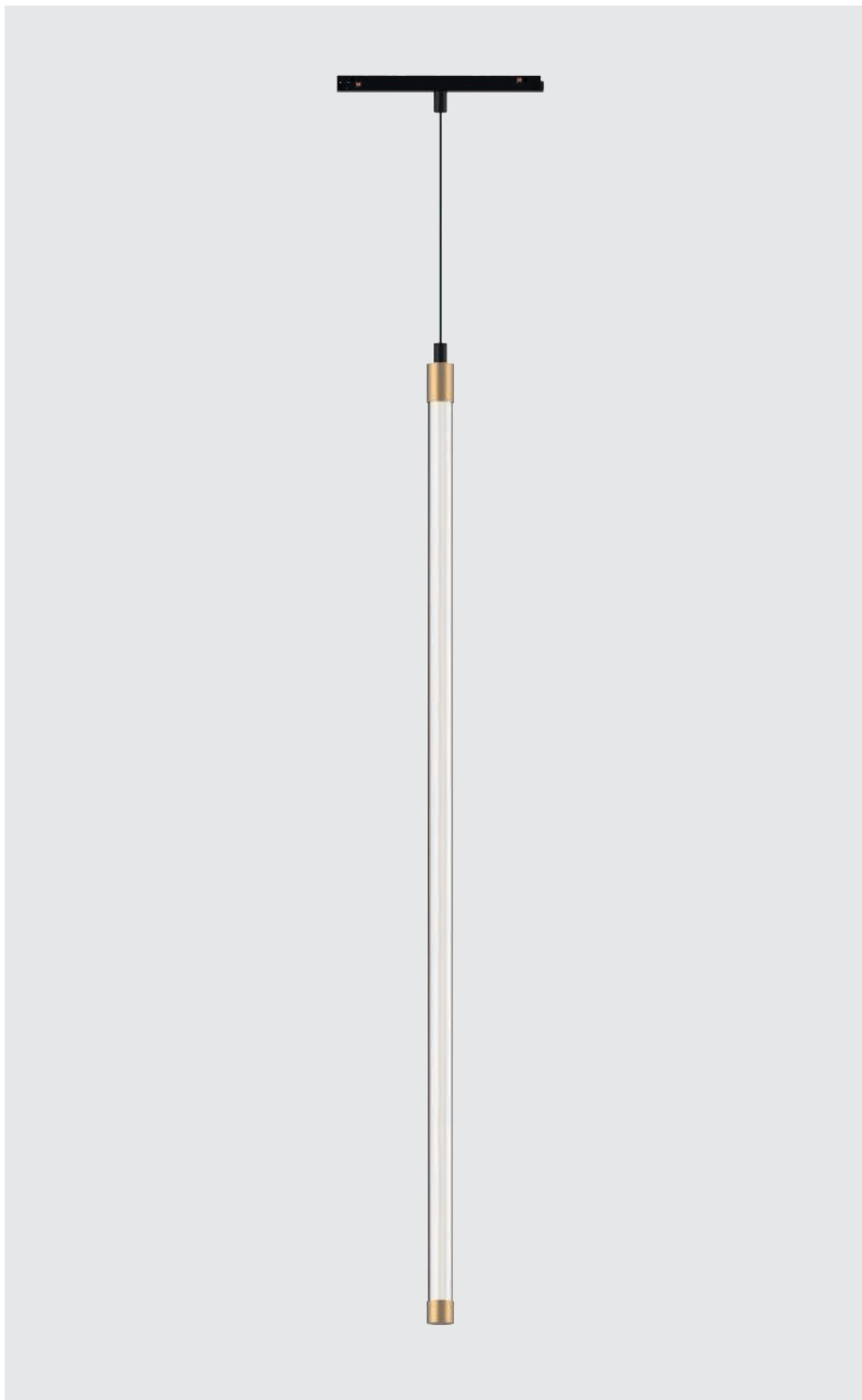
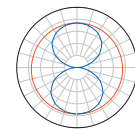

Die minimalistisch gestaltete Neonflex-Pendelleuchte für das LINE48V Niedervolt-System sorgt für eine exzellente Akzentbeleuchtung mit einem 360°-Lichtaustritt. Die Lichteinsätze werden durch einen einfachen Einrastmechanismus mit dem Profil verbunden, der ein hohes Maß an Flexibilität ohne den Einsatz von Werkzeugen bietet.

The minimalist designed neon flex pendant luminaire for LINE48V ensure excellent accent lighting with a 360° light emission. The light inserts will be connected to the profile by a simple click-in mechanism, which offers a high degree of flexibility without using any tools.

Le luminaire suspendu néon flex au design minimaliste pour LINE48V assure un excellent éclairage d'accentuation avec une émission de lumière à 360°. Les inserts lumineux seront connectés au profilé par un simple mécanisme d'encliquetage, ce qui offre un haut degré de flexibilité sans utiliser d'outils.

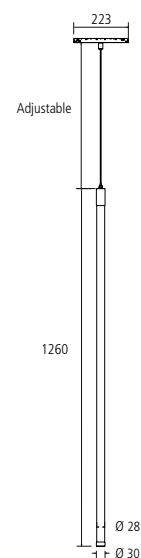

ÜBERSICHT | OVERVIEW | VUE D'ENSEMBLE

LED
CRI >90
3 SDCM
III
>50,000h
180°
48V

colour	dimensions [mm]	pendulum length [mm]	colour temp. [K]	luminous flux [lm]	weight [kg]	material number
■ gold	Ø 30 / L 223 / H 1260	2000	2700	1980	1,25	648RS-059271-OOBLG
■ gold	Ø 30 / L 223 / H 1260	2000	3000	2273	1,25	648RS-059301-OOBLG
■ gold	Ø 30 / L 223 / H 1260	2000	4000	2418	1,25	648RS-059401-OOBLG

LINE48V

ROBE | ROBE | ROBE

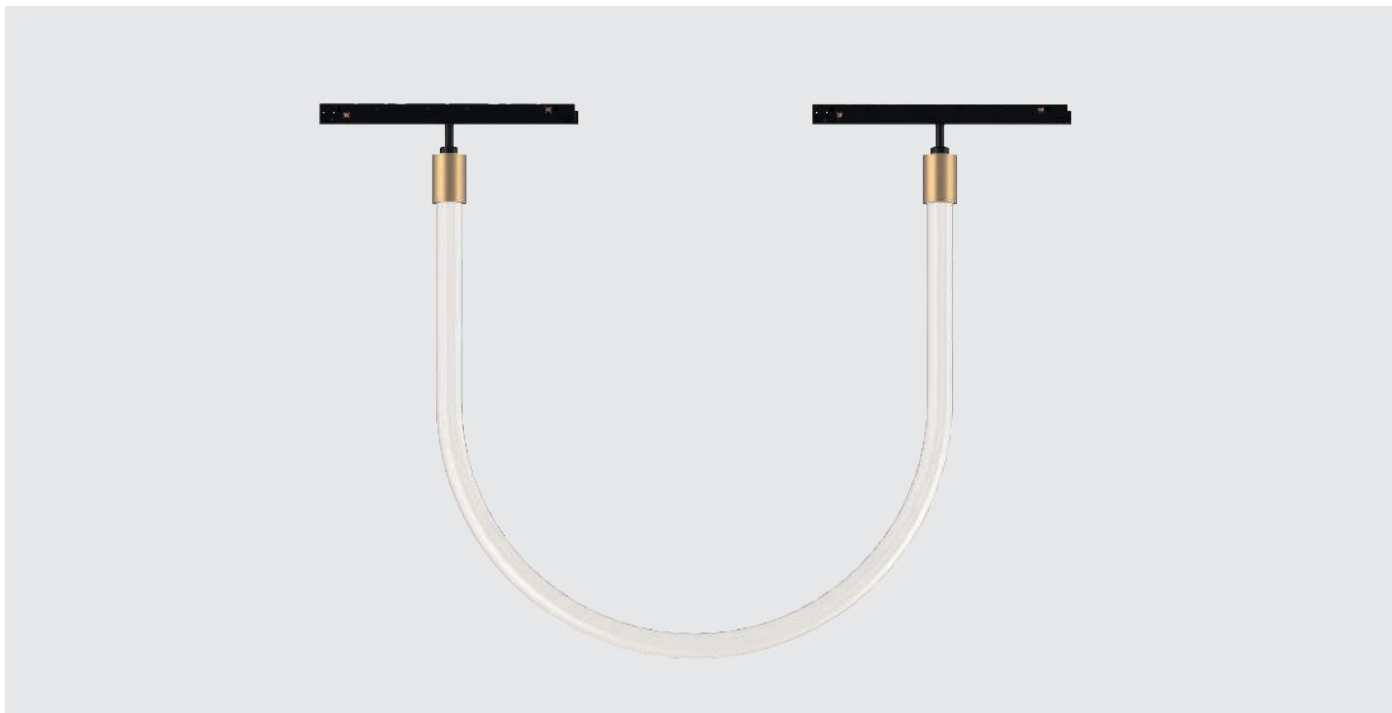
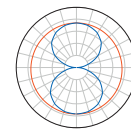

Die minimalistisch gestaltete Neonflex-Pendelleuchte für das LINE48V Niedervolt-System sorgt für eine exzellente Akzentbeleuchtung mit einem 360°-Lichtaustritt. Die Lichteinsätze werden durch einen einfachen Einrastmechanismus mit dem Profil verbunden, der ein hohes Maß an Flexibilität ohne den Einsatz von Werkzeug bietet.

The minimalist designed neon flex pendant luminaire for LINE48V ensure excellent accent lighting with a 360° light emission. The light inserts will be connected to the profile by a simple click-in mechanism, which offers a high degree of flexibility without using any tools.

Le luminaire suspendu néon flex au design minimaliste pour LINE48V assure un excellent éclairage d'accentuation avec une émission de lumière à 360°. Les inserts lumineux seront connectés au profilé par un simple mécanisme d'encliquetage, ce qui offre un haut degré de flexibilité sans utiliser d'outils.

ÜBERSICHT | OVERVIEW | VUE D'ENSEMBLE

LED CRI >90 3 SDCM III >50,000h 180° 48V

19 W 180°

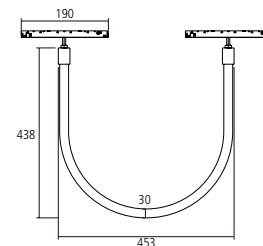

colour	dimensions [mm]	colour temp. [K]	luminous flux [lm]	weight [kg]	material number
gold	Ø 30 / L 190 / H 1200	2700	1980	1,25	648RU-309271-OOBLG
gold	Ø 30 / L 190 / H 1200	3000	2273	1,25	648RU-309301-OOBLG
gold	Ø 30 / L 190 / H 1200	4000	2418	1,25	648RU-309401-OOBLG



LINE48V

IN-TRACK TREIBER 48VDC 100W | DRIVER IN-TRACK 48VDC 100W | DRIVER IN-TRACK 48VDC 100W



ÜBERSICHT | OVERVIEW | VUE D'ENSEMBLE



dimmable	colour	dimensions [mm]	cable length [mm]	power [W]	output voltage [Vdc]	weight [kg]	material number
	■ black [RAL 9005]	L 297,5 / W 16 / H 19	250	100	48	0,14	69351
	□ white [RAL 9016]	L 297,5 / W 16 / H 19	250	100	48	0,14	69353
	■ black [RAL 9005]	L 297,5 / W 16 / H 19	3000	100	48	0,14	69405
	□ white [RAL 9016]	L 297,5 / W 16 / H 19	3000	100	48	0,14	69406
	■ black [RAL 9005]	L 297,5 / W 16 / H 19	250	100	48	0,14	69352
	□ white [RAL 9016]	L 297,5 / W 16 / H 19	250	100	48	0,14	69354
	■ black [RAL 9005]	L 297,5 / W 16 / H 19	3000	100	48	0,14	69409
	□ white [RAL 9016]	L 297,5 / W 16 / H 19	3000	100	48	0,14	69411

DALI: 2 EXTRA LEADS FOR DALI THROUGH WIRING

LINE48V

IN-TRACK TREIBER 48VDC 250W | DRIVER IN-TRACK 48VDC 250W | DRIVER IN-TRACK 48VDC 250W



ÜBERSICHT | OVERVIEW | VUE D'ENSEMBLE

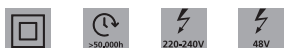

dimmable	colour	dimensions [mm]	cable length [mm]	power [W]	output voltage [Vdc]	weight [kg]	material number
	■ black [RAL 9005]	L 268 / W 22 / H 43,5	250	250	48	0,32	69355
	□ white [RAL 9016]	L 268 / W 22 / H 43,5	250	250	48	0,32	69357
	■ black [RAL 9005]	L 268 / W 22 / H 43,5	3000	250	48	0,32	69407
	□ white [RAL 9016]	L 268 / W 22 / H 43,5	3000	250	48	0,32	69408
	■ black [RAL 9005]	L 268 / W 22 / H 43,5	250	250	48	0,32	69356
	□ white [RAL 9016]	L 268 / W 22 / H 43,5	250	250	48	0,32	69358
	■ black [RAL 9005]	L 268 / W 22 / H 43,5	3000	250	48	0,32	69412
	□ white [RAL 9016]	L 268 / W 22 / H 43,5	3000	250	48	0,32	69413

DALI: 2 EXTRA LEADS FOR DALI THROUGH WIRING

LINE48V

EXTERNER TREIBER 48VDC 320/480W | EXTERNAL DRIVER 48VDC 320/480W | DRIVER EXTERNAL 48VDC 320/480W

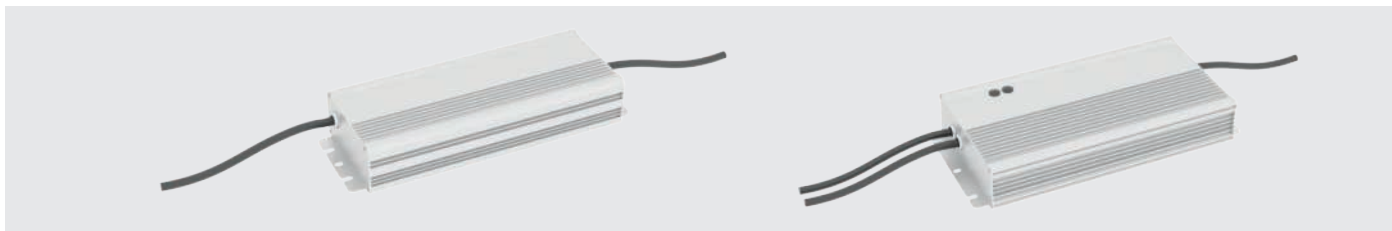

ÜBERSICHT | OVERVIEW | VUE D'ENSEMBLE



dimmable	driver name	colour	dimensions [mm]	cable length [mm]	power [W]	output voltage [Vdc]	weight [kg]	material number
	HLG-320H-48A	■ silver [aluminium]	L 252 / W 90 / H 44	300	320	48	1,88	69361
	HLG-480H-48A	■ silver [aluminium]	L 262 / W 125 / H 19	300	480	48	2,80	69362

LINE48V

OPTOISOLIERTER VERSTÄRKER DALI | OPTO-INSULATED REPEATER DALI | AMPLIFICATEUR OPTO-ISOLÉ DALI
SIGNAL CONTROLLER



Das Gerät ist ein mit dem DALI-Protokoll kompatibler Signalverstärker und Regenerator mit integrierter Stromversorgung für die Ausgangsleitung. Es wird verwendet, um die digitale Eingangsleitung von der Ausgangsleitung zu verlängern oder/und elektrisch zu isolieren. Dank des integrierten Netzteils ist keine Stromversorgung für die DALI-kompatible Ausgangsleitung erforderlich.

The device is a signal repeater and regenerator compatible with DALI protocol including an integrated power supply for the output line. It's used to extend or/and to electrically isolate the digital input line from the output line. Thanks to the integrated power supply, there is no need of a power supply for the output DALI compatible line.

L'appareil est un répéteur et régénérateur de signaux compatible avec le protocole DALI, comprenant une alimentation intégrée pour la ligne de sortie. Il est utilisé pour prolonger et/ou isoler électriquement la ligne d'entrée numérique de la ligne de sortie. Grâce à l'alimentation intégrée, il n'est pas nécessaire d'avoir une alimentation pour la ligne de sortie compatible avec le protocole DALI.

ÜBERSICHT | OVERVIEW | VUE D'ENSEMBLE



dimmable	colour	dimensions [mm]	input voltage [Vdc]	output voltage [Vdc]	output current Dali [mA]	weight [kg]	material number
	□ white	L 172 / W 42 / H 25	24 / 48	24 / 48	250	0,09	69359

FARBENVARIABILITÄT GEHÄUSEFARBEN NACH RAL

COLOUR VARIABILITY – RAL HOUSING COLOURS

VARIABILITÉ DES COULEURS – COULEURS DU BOÎTIER RAL

Standardfarben
default colours
couleurs par défaut

GEHÄUSE | HOUSING | LOGEMENT

DEKORRING | DECORATION RING | DÉCOR ANNEAU
ROUND90 & SQUARE90

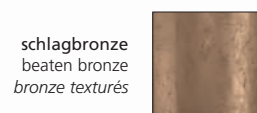
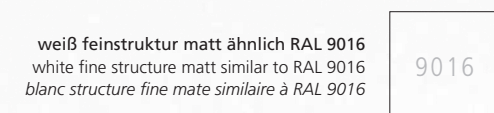
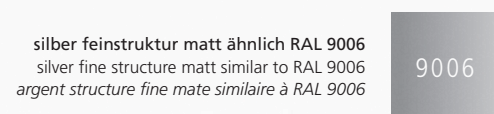
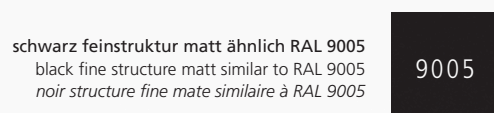
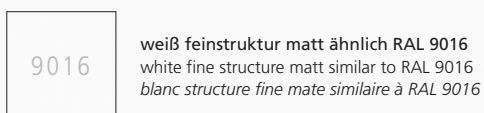
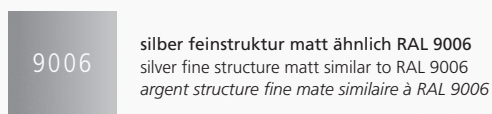
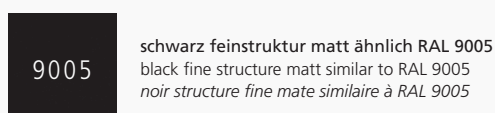

RAL-Farbe nach Wahl auf Anfrage
 RAL colour of your choice on demand
 couleur RAL de votre choix sur demande

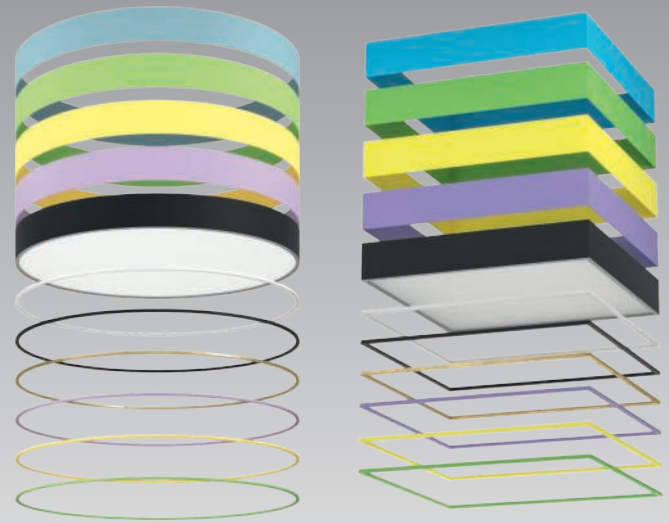

1001	1003	1004	1013	1014					
1015	1016	1018	1019	1021					
1023	1035	1036	2000	2001					
2003	2008	2009	3000	3002	3003	3009	3011	3013	
3016	3018	3020	3031	3032	3033	4005	4010	4011	
4012	5002	5004	5010	5012	5013	5018	5023	5024	
5025	5026	6013	6014	6017	6018	6019	6027	6034	
7001	7004	7006	7011	7012	7013	7015	7016	7021	
7022	7024	7030	7031	7032	7035	7037	7038	7039	
7043	7044	7047	7048	8003	8011	8012	8016	8017	
8019	8024	8028	8029	9001	9003	9011	9017	9022	

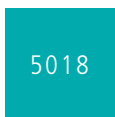

EGLO Farbe RAL 5018
 EGLO colour RAL 5018
 EGLO couleur RAL 5018

LEGENDE & PIKTOGRAMME

LEGEND & PICTOGRAMS | *LÉGENDE & PICTOGRAMMES*

FASSUNGEN | SOCKETS | *DOUILLES*

 LED

 GU10

VOLT | VOLTAGE | *VOLTAGE*

 3-Phasenschienen | 3-phase track spotlight | *projecteur sur rail phases*

 24V

 48V

 220-240V 50/60Hz

 230V AC

FUNKTIONEN & KOMFORT | FUNKTIONS & CONFORT | *FONCTIONS & CONFORT*

 Colour Rendering Index (80, 90, 92, 95)

 MacADAM Step (SDCM2-/3-/6)

 Lebensdauer | lifetime | *durée de vie (50.000h, 62.000h, 100.000h)*

 schwenkbar | swiveling | *tournant*

 drehbar | rotatable | *rotatif*

FUNKTIONEN & KOMFORT | FUNKTIONS & CONFORT | *FONCTIONS & CONFORT*

 Ausstrahlwinkel | beam angle | *angle de rayonnement*

 Ausschnitt (in mm) | cutout (in mm) | *perçage du panneau (en mm)*

 Einbaubreite (in mm) | installation width (in mm) | *largeur d'installation (en mm)*

 Einbautiefe (in mm) | Mounting Depth (in mm) | *Profondeur de montage (en mm)*

 vereinheitlichte Blendungsbewertung | unified Glare Rating | *d'Évaluation unifiée de l'éblouissement (UGR 12, 16, 19, 22)*

 Insect-protected | insektengeschützt | *Protection contre les insectes*

 ball-proof | ballwurfsicher | *anti-balles*

 Sensor | sensor | *sensor*

 nicht dimmbar | not dimmable | *ne pas graduable*

 dimmbar | dimmable | *gradable*

 DALI 2

 touchpanel

 Pushbutton

 Fernbedienung | remote control | *télécommande*

 TRIAC

 UKCA

 CE

BESONDERER FUNKTIONEN |
SPECIAL LEVEL OF FUNCTION | NIVEAU SPÉCIAL DE FONCTION



insektengeschützt | insect-protected | protection contre les insectes

Es handelt sich hier um eine insekten- und staubgeschützte Leuchte. Hierbei ist zumindest das Leuchtgehäuse und die sichtbare Leuchtfläche so geschützt, dass keine Insekten eindringen können. (Entspricht IP50).

This is an insect- and dust-proof luminaire. In this case, at least the luminaire housing and the visible illuminated surface shall be protected in such a way that insects cannot penetrate. (equivalent to IP50).

Il s'agit d'un luminaire résistant aux insectes et à la poussière. Dans ce cas, au moins le boîtier du luminaire et la surface éclairée visible doivent être protégés de manière à empêcher les insectes de pénétrer. (équivalent à IP50).



ballwurfsicher | ball-proof | anti-balles

Ballwurfsicherheit nach | Ball-proof according to | Résistant aux balles selon la norme
DIN18032-3

SCHUTZGRAD |
PROTECTION RATING | INDICE DE PROTECTION

Der Schutzgrad gewährleistet die Betriebssicherheit von Leuchten. Die erste Ziffer des IP Grades beschreibt den Schutzzumfang gegen das Eindringen von Fremdkörpern, die zweite Ziffer informiert über den Grad des Feuchtigkeitsschutzes.

The protection rating ensures the operational safety of luminaires. The first number specifies the extent of the protection against the ingress of foreign bodies; the second number identifies the humidity protection grade.

L'indice de protection assure la sécurité opérationnelle des luminaires. Le premier chiffre indique à quel point la protection est efficace contre l'insertion de corps étrangers; le second chiffre indique quant à lui le degré de protection par rapport à l'humidité.

IP 20	IP20	IP40 IP50	IP40/50	IP 65	IP65
IP20 IP50	IP20/50	IP 44	IP44	IP 66	IP66
IP20 IP54	IP20/54	IP 50	IP50	IP 67	IP67
IP 40	IP40	IP 54	IP54		

SCHUTZKLASSE |
PROTECTION CLASS | CLASSE DE PROTECTION

Die Schutzklasse gibt an, inwiefern ein Produkt gegen einen elektrischen Schlag gesichert ist. Alle Leuchten in diesem Katalog sind mit mindestens Schutzklasse 1 gesichert, bei höheren Klassen wird das Symbol im Infokasten der Leuchte angegeben.

The protection class indicates to what extent the luminaire is protected against electric shock. All luminaires in this catalogue are at least protected with the protection class 1 - a higher class is specified in the information box of the respective luminaire.

La classe de protection indique, dans quelle mesure la lampe est protégée contre les chocs électriques. Tous les lampes dans ce catalogue sont protégées au moins avec la classe 1 - une classe plus élevée est indiquée dans l'information de la luminaire.



Schutzklasse 1: Schutzerdung
protection class 1: protective earthing
classe de protection 1: prise de terre



Schutzklasse 2: Schutzisolierung
protection class 2: protective insulation
classe de protection 2: double isolation ou renforcée



Schutzklasse 3: Schutzkleinspannung
protection class 3: protective low voltage
classe de protection 3: très basse tension de sécurité

NOTIZEN

NOTES | *NOTES*

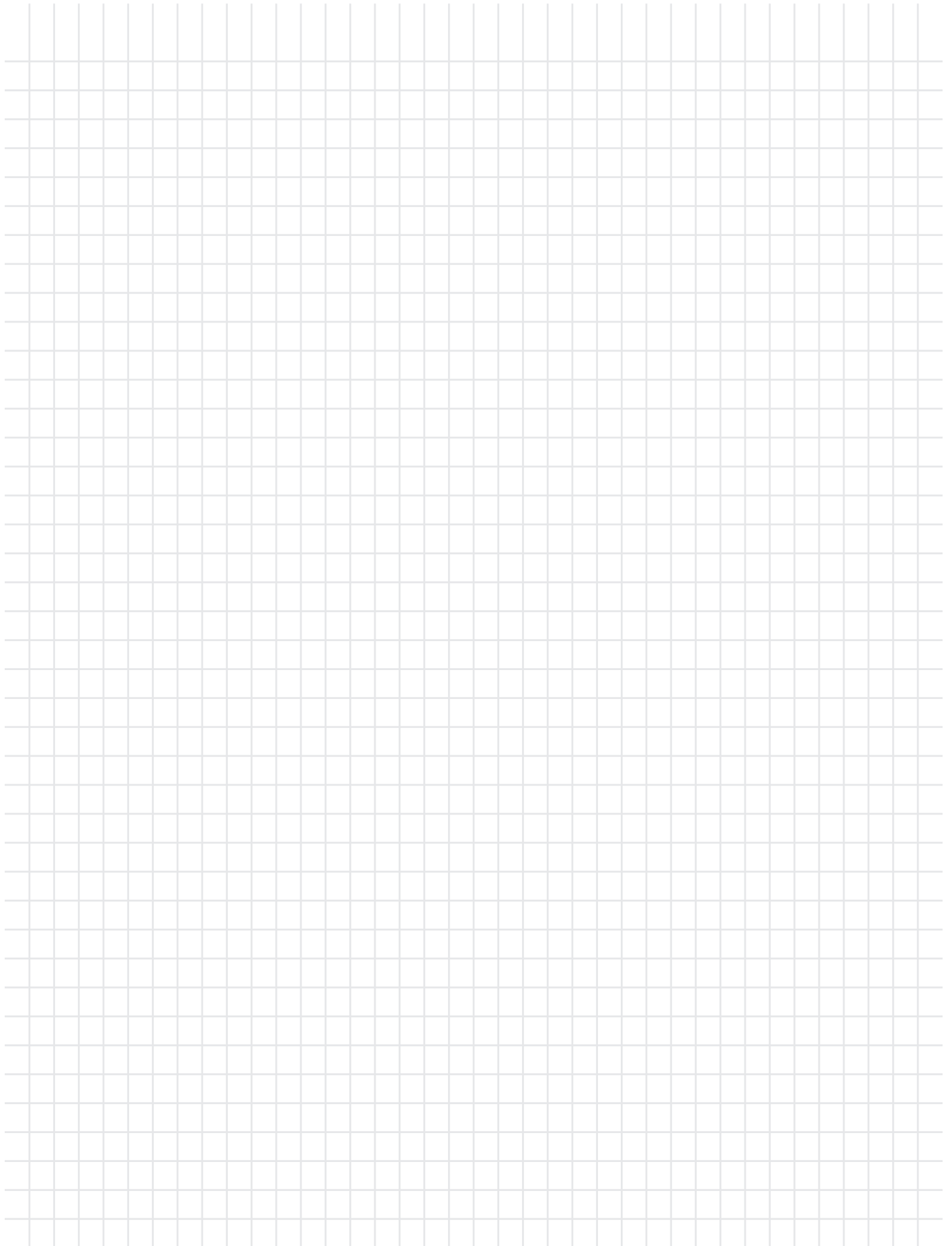



NOTIZEN

NOTES | NOTES

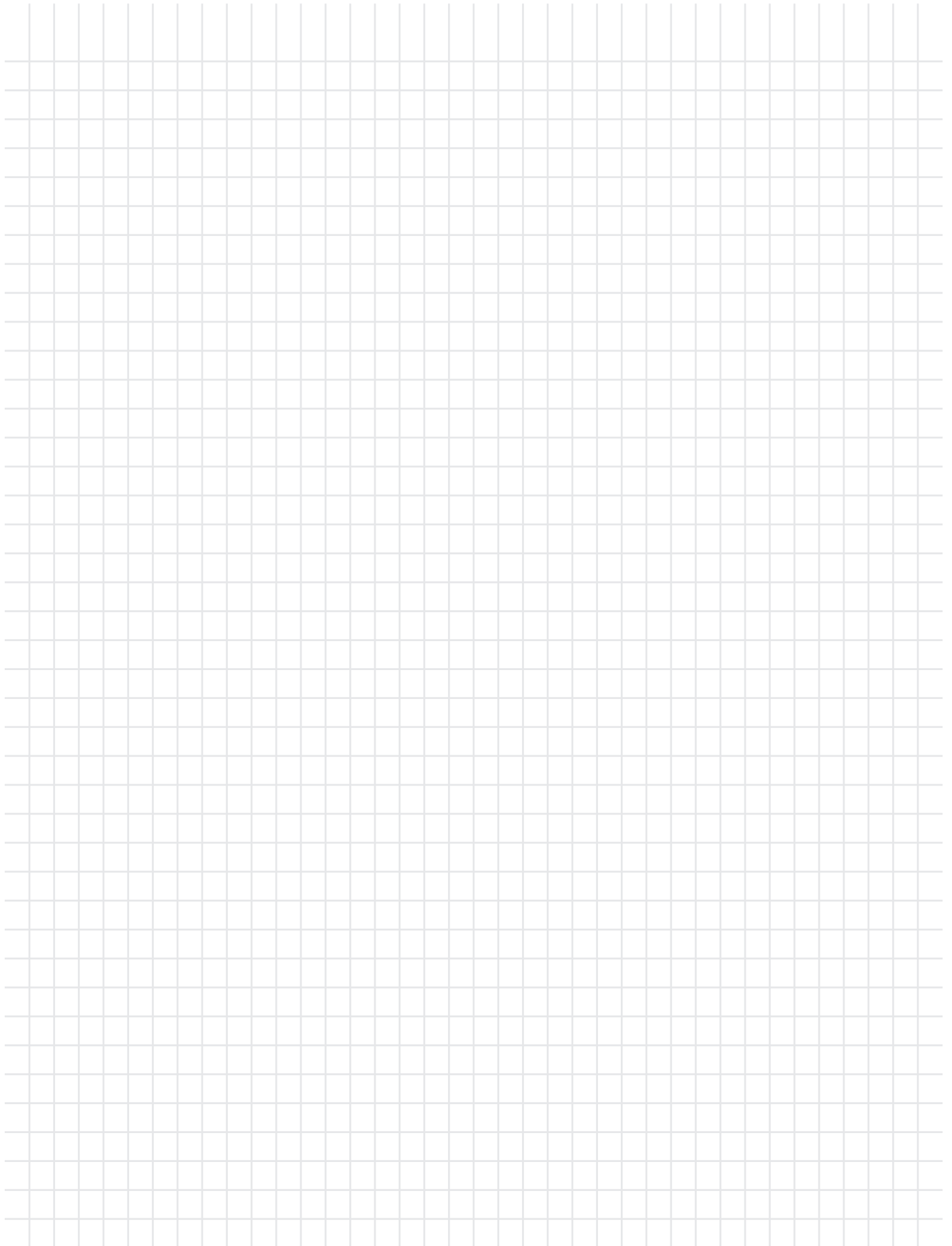

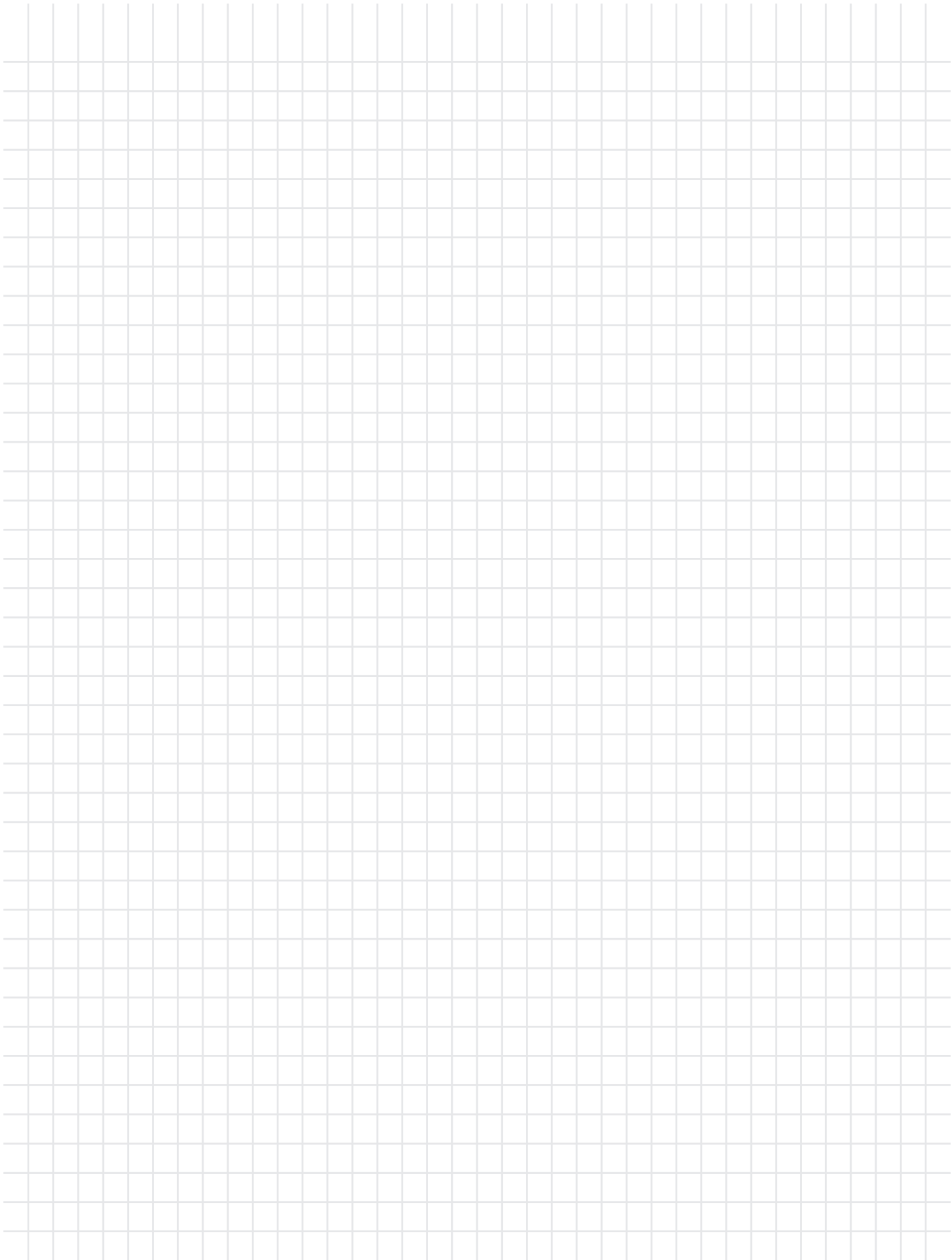

NOTIZEN

NOTES | NOTES

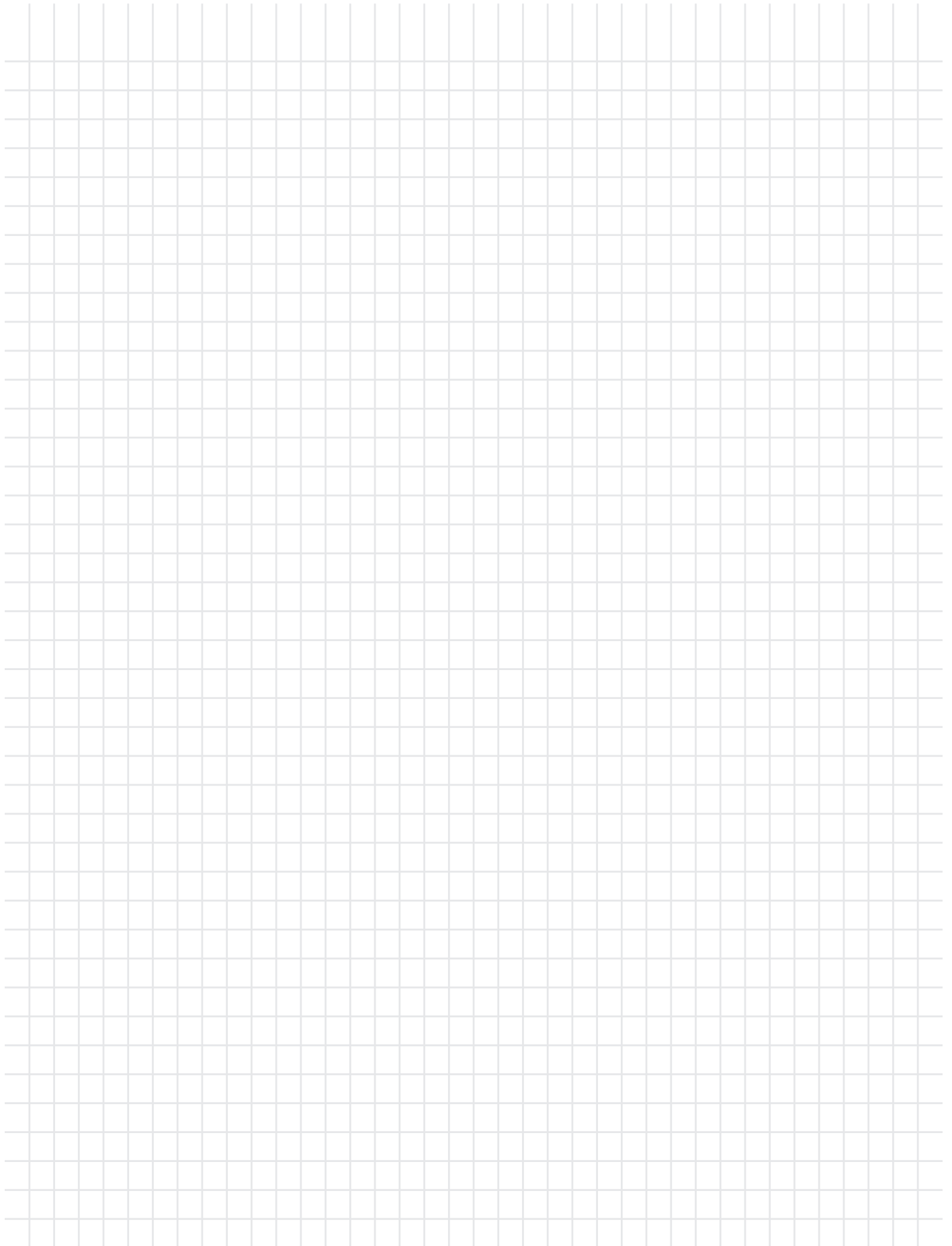



Mit diesem Katalog verlieren alle vorhergehenden Kataloge und Preislisten ihre Gültigkeit.

Irrtümer, Druckfehler, Modell- und Preisänderungen sowie technische Änderungen vorbehalten. Wir liefern zu unseren Liefer- und Zahlungsbedingungen. Unsere Produkte entsprechen der europäischen Leuchtennorm EN 60598. Produkte mit dem ENEC Prüfzeichen sind konform mit der Richtlinie 2006/95/EG. Produkte mit weiteren Sicherheitshinweisen (zB. Schutzklasse, IP) sind mit Symbol und Zahl bei der Produktfamilie ausgezeichnet.

Der Inhalt dieses Kataloges ist für die EGLO Leuchten GmbH urheberrechtlich geschützt. Alle Rechte sind vorbehalten.

Bilder und Texte dürfen nicht ohne vorherige ausdrückliche, schriftliche Genehmigung verwendet werden.

Die Abbildungen sind 4C Drucke und können vom Original abweichen. Die Katalogbilder und die gezeigten Darstellungen der Produkte können von der Wirklichkeit abweichen und nicht den üblichen Produktanwendungen entsprechen. EGLO übernimmt keine Haftung für die Richtigkeit, Vollständigkeit und Anwendungsdarstellung der Produkte und Produktinformationen.

Gestaltung, Layout und Satz:
EGLO Leuchten GmbH, A-6136 Pill - AUSTRIA

Druck: Gutenberg-Werbering GmbH,
4040 Linz - AUSTRIA

Bilder: EGLO, Adobe Stock, istockphoto.com

All previous catalogues and price lists are no longer valid with the issue of this catalogue.

Errors, misprints, model and price changes and technical modifications are reserved. We deliver based on our terms of delivery and payment. Our products comply with the European light norm EN60598. Products with the ENEC test mark are conforming to the guide line 2006/95/EG. Products with additional safety remarks (e.g protection class, IP) are identified within the product family with the relevant symbol and number.

The content of this catalogue is protected under copyright law for EGLO Leuchten GmbH. All rights reserved.

Our specific written consent must be obtained before using any illustrations and texts. The pictures are 4C prints and may differ from the original. The product pictures and ambiances in this catalogue can deviate from reality, and they do not necessarily concur with the usual application of the product. EGLO does not assume liability for the correctness, completeness or the application depiction of the products and/or the product information.

Design, layout and composition:
EGLO Leuchten GmbH, A-6136 Pill - AUSTRIA

Print: Gutenberg-Werbering GmbH,
4040 Linz - AUSTRIA

Pictures: EGLO, Adobe Stock, istockphoto.com

Le présent catalogue remplace tous les catalogues et tarifs précédents.

Sous réserve d'erreurs, de fautes d'impression, de modification des modèles et de changement de prix et de technique. Nous livrons sur la base de nos conditions de livraison et de paiement. Nos produits sont conformes aux normes européennes EN 60598 et portent le marquage CE. Les produits portant la marque ENEC sont conformes à la Directive 2006/95/EG. Les produits portant d'autres indications de sécurité (par exemple classe de protection, IP) sont identifiés par le symbole et le nombre correspondants dans la famille de produits.

Le contenu du présent catalogue est protégé pour la société EGLO Leuchten GmbH par un copyright. Tous droits réservés.

Toute reproduction d'images et du texte est interdite sans autorisation explicite par écrit préalable. Les images sont imprimées en 4C et peuvent différer de l'original. Les images des produits et les ambiances dans le catalogue peuvent dévier de la réalité et ne sont pas nécessairement en ligne avec l'usage habituel du produit. EGLO n'engage pas sa responsabilité sur la justesse des images et sur les informations relatives à l'usage pouvant être fait des produits.

*Conception, maquette et composition:
EGLO Leuchten GmbH, A-6136 Pill - AUSTRIA*

*Presse: Gutenberg-Werbering GmbH,
4040 Linz - AUSTRIA*

Images: EGLO, Adobe Stock, istockphoto.com

01-2025



EGLO Leuchten GmbH
Heiligkreuz 22
A-6136 Pill
Austria
Tel. +43 (0) 5242 6996
Fax +43 (0) 5242 6996-972
info@eglo.com
professional.eglo.com

KATPRO25-P

my light | my style